

# alea

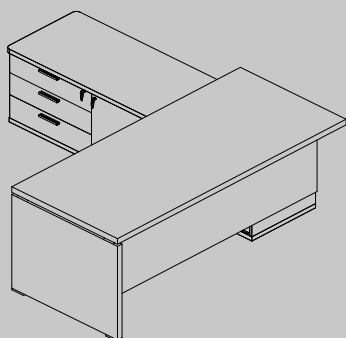

odeon

---

direzionali | executive | mobilier de direction | ejecutivos

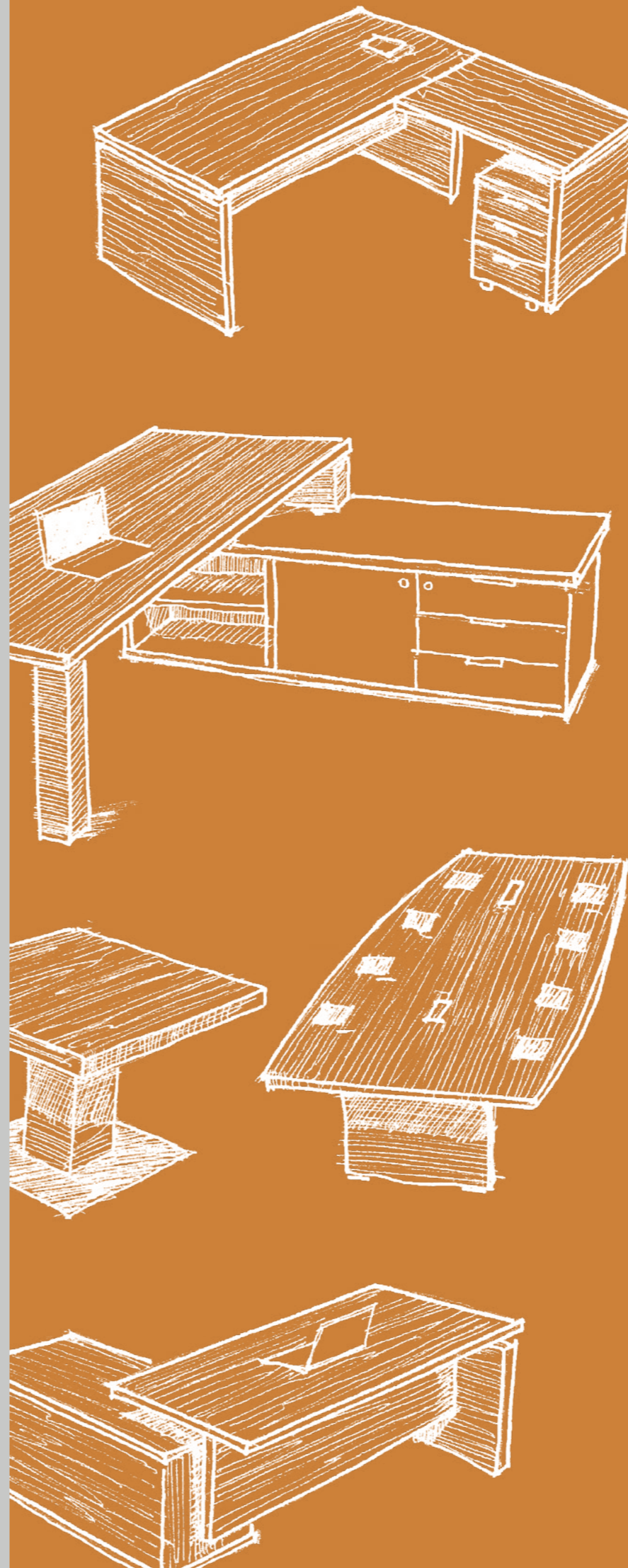

## Abbiamo rinnovato un classico bestseller

inserendo nuove soluzioni e combinazioni di finiture

We have renewed a classic bestseller by introducing new solutions and combinations of finishes

Nous avons renouvelé un best-seller en intégrant de nouvelles solutions et combinaisons de finitions

Hemos renovado un clásico introduciendo nuevas soluciones y combinaciones de acabados



**/structural storage** Odeon managerial system, characterised by panel legs that support 40 mm thick worktops, has been combined with new structural storage with an open compartment, sliding door, CPU compartment and a choice of drawers. The storage features a false back to accommodate cables.

**/rangements structurels** au système exécutif Odeon, caractérisés par des pieds-panneaux qui supportent des plans de travail épais de 40 mm. un nouveau rangement structurel a été combiné avec un compartiment ouvert, une porte coulissante, un compartiment pour CPU et un module à trois tiroirs ou un tiroir de classement vertical. Le module de rangement a un double dos pour le passage vertical des câbles.

**/muebles de servicio** la colección ejecutiva Odeon se compone de patas-panel que soportan sobres de trabajo de 40 mm de grosor. Hemos combinado un nuevo mueble auxiliar estructural con vano abierto, puerta corredera, soporte CPU y cajonera 3 cajones o 1 cajon con archivador. El mueble esta equipado con vano tecnico para acceso al compartimiento interior para la subida de los cables.

## /contenitori strutturali

Al sistema direzionale Odeon, caratterizzato da gambe pannellate che sostengono piani lavoro di spessore 40 mm, è stato abbinato un nuovo contenitore strutturale con vano a giorno, anta scorrevole, vano porta CPU e cassettera tre cassetti o cassetto classificatore. Il contenitore prevede una doppia schiena per il transito verticale dei cavi.







**meeting tables** a new family of meeting tables has been added. Square and rectangular tables with panel legs or round bases. To suite with the desk design we offer a folded column base, that also allows access for cables from floor to top if required. This rests on a painted steel base.

**tables de réunion** une nouvelle famille de tables de réunion, carrées ou rectangulaires, a été ajoutée aux tables avec pieds panneaux et bases rondes en métal. Ces tables se caractérisent par un pied de colonne en tôle pliée et adaptable au passage vertical du câblage grâce à des rabats spéciaux. La colonne repose solidement sur une plaque métallique peinte.

**mesas de reuniones** hemos adjuntado una nueva línea de mesas de reuniones. Las nuevas mesas de reunión pueden ser cuadradas o rectangulares y se caracterizan por la columna cuadrada que soporta el tablero realizada en "folding" y adaptable al tránsito vertical del cableado gracias a los pasacables. La columna apoya sobre base metálica cuadrada realizada por una pletina de metal pintada.

## /tavoli riunione

Una nuova famiglia di tavoli riunione, quadrati o rettangolari, si è aggiunta ai tavoli con gambe pannellate e basi metalliche rotonde. Sono caratterizzati da un basamento a colonna realizzata in folding e adattabile al passaggio verticale del cablaggio grazie ad appositi passacavi. La colonna poggia solidamente su una piastra in metallo verniciato.











## /integrazione

Le scrivanie Odeon si abbinano a tutte le librerie e ai contenitori del catalogo Alea. L'interazione di stili e materiali tra gli elementi di diverse collezioni, fornisce costantemente nuove fonti di ispirazione. Librerie Titano e credenze Blade infatti, si integrano con la scrivania alla perfezione.

***Integration** Odeon desks suite with all the bookcase and storage options in the Alea portfolio. Design and material finishes are common across the ranges to fuel inspiration. Titano bookcases and Blade credenzas perfectly complete the solution.*

***l'intégration** les bureaux Odeon se marient bien avec toutes les bibliothèques et rangements du catalogue Alea. L'interaction en terme de style et de matériau entre les éléments des différentes collections fournit constamment de nouvelles sources d'inspiration. Les bibliothèques Titano et les crédences Blade s'intègrent parfaitement avec le bureau.*

***Integración** los escritorios de Odeon se combinan con todos los libreros y contenedores del catálogo Alea. La interacción entre elementos de diferentes colecciones es fuente de inspiración. Libreros Titano y contenedores Blade se mezclan a la perfección.*





---

### **/combinazioni di finiture**

Per tutti gli elementi che compongono la serie Odeon, scrivanie e contenitori, è possibile combinare diverse finiture tra loro in maniera da personalizzare completamente l'arredo. Le moltissime opzioni di colore consentono abbinamenti sorprendenti.



***Combinations of finishes** for all Odeon elements, desks and storage units, it is possible to combine different finishes to completely customize the furniture. The many colour options allow surprising combinations.*

***Combinaisons de finitions** pour tous les éléments qui composent la série Odeon, les bureaux et les rangements, il est possible de combiner différentes finitions entre elles afin de personnaliser l'ensemble du mobilier. Les nombreuses options de couleurs permettent des combinaisons surprenantes.*

***Combinaciones de acabados** la colección Odeon ofrece varias combinaciones de acabados para escritorios y contenedores que permiten de personalizar completamente el mobiliario. La variedad de colores crean resultados sorprendentes.*





***l corner legs** in addition to panel leg desk with with structural lateral storage, it is also available the one with square section corner legs 90x90 mm which can be used for vertical cable transit, thanks to the use of grommets.*

***l pieds d'angle** en plus des bureaux avec pieds panneaux et ceux constitués de rangements structuraux latéraux, il y a ceux avec des pieds angulaires à section carrée de 90x90 mm, qui sont munis de passe-câbles, permettant le passage de l'électrification.*

## **/gambe angolari**

Oltre alla scrivania con gambe pannellate e con contenitore laterale strutturale, è disponibile anche quella con gambe angolari a sezione quadrata 90x90 mm che, con l'applicazione di passacavi, possono essere utilizzate per il transito dell'elettrificazione.



***l patas cuadradas** además del escritorio con patas paneladas y contenedor lateral estructural, también está disponible el con patas de esquinas de sección cuadrada que, con la aplicación de un pasacables, pueden usarse para el tránsito de la electrificación.*





## **/flessibilità**

Abbinamenti di diversi materiali e complementi, permettono di moltiplicare le possibili soluzioni d'arredo. L'accostamento tra le essenze del legno e gli inserti in cuoio conferiscono alla scrivania un prestigio particolare. L'utilizzo di credenze sospese con dettagli in metallo impreziosisce tutto l'ambiente.

***flexibility** being able to integrate different materials raises the design. The combination of wood, metal and leather give Odeon a particular prestige. Using suspended sideboards with painted metal detail enriches the whole environment.*

***flexibilité** favorisé par la possibilité de puiser dans différents matériaux et compléments, permet de diversifier le niveau du mobilier. Le choix des essences de bois combinées aux inserts en cuir confèrent au bureau une élégance particulière. L'utilisation de crédences suspendues avec des détails métalliques, rend tout l'environnement plus élégant.*

***flexibilidad** combinaciones de diferentes materiales y complementos permiten de incrementar las oportunidades. La combinación de madera y cuero confieren al escritorio un prestigio particular. El uso de contenedores suspendidos con detalles en metal embellece el resultado.*







**I match** Alea cabinets with hinged doors, combined with the Odeon series, present also the option with satin-finish or back-lacquered acrylic with anodised aluminium frame. The material has many different colours that can be combined with the wood or melamine finishes of desks and drawer units.

**I assortiments** les armoires Alea à portes battantes associées à la série Odeon amplifie l'offre avec des panneaux en acrylique transparents ou laqués, assemblés avec des cadres en aluminium anodisé. Ces éléments offrent de nombreuses couleurs différentes qui peuvent être combinées avec les finitions en bois ou en mélamine des bureaux et des tiroirs.

**I combinaciones** los armarios de Alea con puertas batientes que se combinan con la colección Odeon, están disponibles en metacrilato (también lacado por detrás) con perfil en aluminio. Este material puede ser de diferentes colores que se combinan con los acabados madera o melamina de los escritorios y cajoneras.

## /abbinamenti

Gli armadi Alea ad ante battenti abbinati alla serie Odeon presentano anche l'opzione in metacrilato satinato o retro-laccato con telaio in alluminio anodizzato. Questo materiale ha molti colori diversi che possono abbinarsi alle finiture legno o melaminico delle scrivanie e delle cassettiere.





30  
wed

---

## /vetro

Il piani in vetro di Odeon presentano una cornice in alluminio perimetrale di spessore 40 mm che può essere anodizzata/spazzolata o verniciata a polveri epossidiche. I vetri sono disponibili sia nella versione retro-laccata che in quella antimpronta. Su richiesta si possono applicare gli sportelli passacavi anche sui piani in vetro.



***I glass** Odeon glass tops have a 40 mm thick perimeter aluminium frame that can be anodized/brushed or epoxy powder coated. Glass is available in both back-lacquered and anti-finger versions. On request it is also possible to apply the top accesses to the glass tops.*

***I verre** les plateaux en verre d'Odeon sont dotés d'un cadre en aluminium pouvant être anodisé/brossé ou vernis poudres époxy. Ils ont une épaisseur de 40 mm d'épaisseur. Les verres sont disponibles dans les versions rétro-laquées et anti-taches. Sur demande, les accès passe-câbles peuvent également être installés sur les étagères en verre.*

***I vidrio** los tableros en vidrio tienen un borde de aluminio extruido 40 mm de grosor en acabado brillante/anodizado o pintado epoxi. Los vidrios están disponibles en cristal retro lacado y posible tratamiento antihuella en la parte superior. A petición los tableros en vidrio pueden equiparse con pasacables.*





## /briefing

Alla scrivania Odeon possono essere applicate appendici frontali "briefing" di varie dimensioni che consentono di attrezzarla per esclusivi meeting direzionali. La struttura presenta il design e i materiali della scrivania.

***/briefing** Odeon desk can be fitted with frontal briefing table in various sizes that allow to set up exclusive executive meetings. The structure is made with the same design and materials of the desk.*

***/briefing** des appendices frontaux "briefing" de différentes tailles peuvent être ajoutés au bureau Odeon lui permettant de l'équiper d'une table pour des réunions de direction "exclusives". La structure reproduit le design et reprends les matériaux du bureau.*

***/briefing** para proporcionar espacio para reuniones ejecutivas, a la mesa principal, se pueden adjuntar mesas briefing de varias dimensiones. Design y materiales son los mismos del escritorio.*



## /elettrificazione

Ogni tavolo riunione Odeon, a seconda della sua struttura, prevede una soluzione per la gestione del cablaggio. Nei tavoli con basamenti metallici rotondi, il flip-top supporta una vasca per sostenere le prese e si completa con una vertebra per il transito verticale dei cavi.



***l'electrification** each Odeon meeting table, depending on its structure, provides a solution for wiring management. In tables with round metal bases grommets support a basket to hold sockets and is completed with a cable duct for cables vertical transit.*

***l'électrification** chaque table de réunion Odeon, selon sa structure, offre une solution pour la gestion des câbles. Les tables avec des pieds métalliques ronds, le flip-top offre un accès à une corbeille qui soutient les prises. Une vertèbre gère le transit vertical des câbles.*

***l'elettrificación** cada mesa de reunión contempla una solución para la electrificación en función de la estructura de la mesa. En las mesas con bases metálicas circulares una cesta para los accesorios se engancha al flip top y se completa con una vertebra para electrificación vertical.*



## /tavoli modulari

I tavoli modulari sono realizzati con gambe pannellate collegate tra loro da una trave strutturale in alluminio. I tavoli possono essere estesi a qualsiasi dimensione e sono disponibili sia in melaminico che in essenza di legno.

***/modular tables** modular tables are made with panel legs connected linked by an aluminium structural beam. Tables can be extended to any size and are available both in melamine and wood veneer.*

***/tables modulaires** les tables modulaires sont fabriquées avec des pieds panneaux reliés entre eux par une poutre structurelle en aluminium. Les tables peuvent s'adapter à n'importe quelle taille et elles sont disponibles à la fois en mélamine et en placage de bois.*

***/mesas modulares** en las mesas de reunión modulares las patas están siempre revestidas de paneles, unidas entre sí por una viga estructural de aluminio. Las mesas se pueden ampliar a cualquier dimensión y están disponibles en melamina y madera.*







## /inserto in pelle

Nei tavoli modulari realizzati in essenza è possibile applicare un inserto in cuoio con cuciture a contrasto. A discrezione del cliente è possibile applicare anche i top access sulla superficie rivestita.



***Leather insert** in wood modular tables it is possible to apply a leather insert with visible stitching. At the customer's discretion it is also possible to apply the top access on the upholstered surface.*

***Insert en cuir** dans les tables modulaires en bois: il est possible d'insérer une pièce ou un sous-main en cuir avec des coutures de couleur contrastantes ou pas. Selon la volonté du client, des top-access peuvent également être appliqués à la surface revêtue.*

***Inserto de cuero** en las mesas de reunión modulares en madera chapada, se puede aplicar un precioso inserto de cuero. A petición del cliente es posible aplicar los top access en la superficie tapizada.*







***I tidiness** the structural beam used to connect legs and support table tops provides space for horizontal cable management. In fact, top accesses are placed directly on it and exploit the cavity.*

***L'ordre** la poutre structurelle utilisée pour relier les jambes entre-elles et à la fois soutenir le dessus de la table, elle offre un espace pour le passage ordonné des câbles horizontalement. Les top access sont positionnés directement sur elle et profitent de son espace intérieur.*

***I orden** la viga estructural que se utiliza para la unión de las patas permite el tránsito de los cables en sentido horizontal. El top access se coloca por encima en correspondencia de la viga aprovechando del espacio en su interior.*

---

## **/ordine**

La trave strutturale utilizzata per collegare tra loro le gambe e supportare i piani del tavolo, offre lo spazio per il transito ordinato dei cavi in senso orizzontale. I top access infatti sono posizionati direttamente su di essa e ne sfruttano la cavità.



/finiture piano | top finishes | finitions plateau | acabados sobre

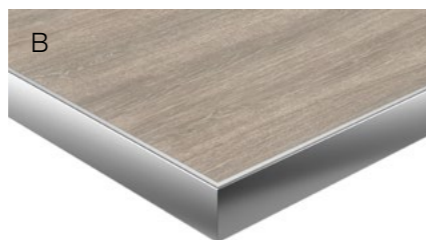

**Melaminico senza (A) e con profilo (B)\***  
 Italian melamine without (A) and with profile (B)\*  
 Mélamine sans (A) et avec profil (B)\*  
 Melaminico sin (A) y con perfil (B)\*



**Legno senza (C) e con profilo (D)\***  
 Wood veneer without (C) and with profile (D)\*  
 Bois sans profilé (C) et avec profilé (D)\*  
 Madera sin (C) y con perfil (D)\*

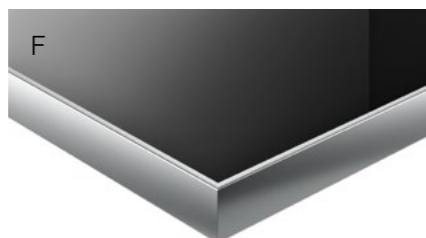
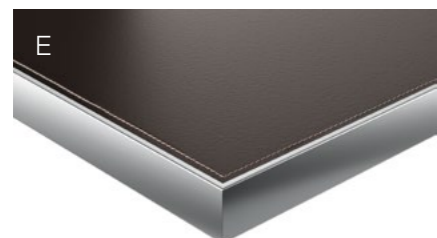

**Cuoio (E), vetro (F) e gres (G) con profilo\***  
 Leather (E), glass (F) and porcelain tiles (G) with profile\*  
 Cuir (E), verre (F) et grès (G) avec profil\*  
 Cuero (E), vidrio (F) y gres porcelánico (G) con perfil\*

**\*Il profilo metallico del piano può avere le seguenti finiture: anodizzato, brill, epossidico**  
 \*The metal profile of the table top, can have the following finishes: anodised, brill, epoxy  
 \*Le profil métallique du dessus peut avoir les finitions suivantes: anodisé, brillant, époxy  
 \*El perfil metálico del sobre puede ser anodizado, brillante, pintado epoxy



/forme dei piani | desk top shapes | formes de plateaux | formas de sobres

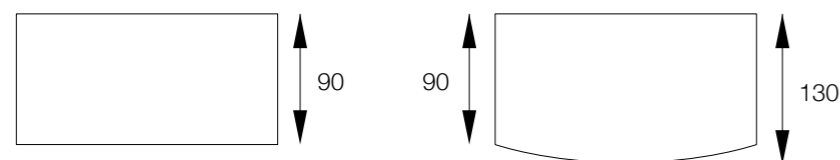

/gambe | legs | pieds | patas

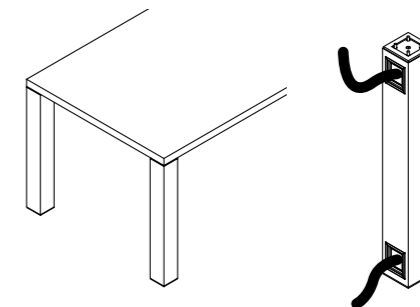
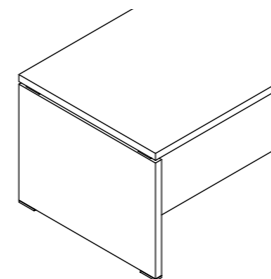

**gambe pannellate legno/melaminico**  
 panel legs - wood veneer/Italian melamine  
 piètements panneaux - bois/mélangé  
 patas paneladas - madera/melaminico

**gambe angolari legno/melaminico**  
 corner legs - wood veneer/Italian melamine  
 piètements d'angle - bois/mélangé  
 patas angulares - madera/melaminico

/scrivania singola | single desk | bureau individuel | mesa individual

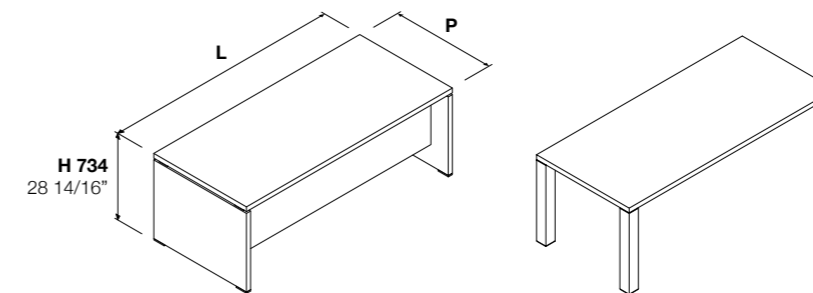

	L 1800   70 14/16"	L 2000   78 12/16"			
P 900   35 7/16"	•	•			

/scrivania con muretto | desk with extended leg | bureau avec pied panneau prolongée | mesa con costado lateral

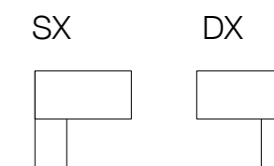
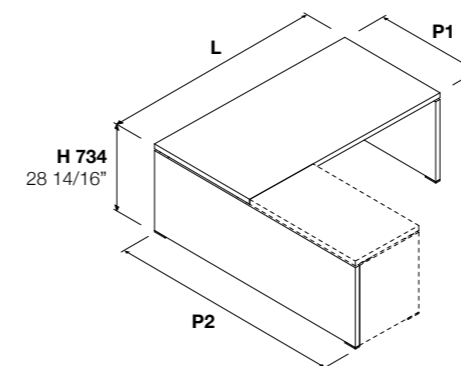

	L 1800   70 14/16"	L 2000   78 12/16"			
P1 900   35 7/16"	•	•			
P2 1900   74 13/16"					
P1 900   35 7/16"	•	•			
P2 2100   82 11/16"					

**/scrivania per mobile di servizio** | desk for service unit | bureau pour meuble retour | mesa para mueble auxiliar

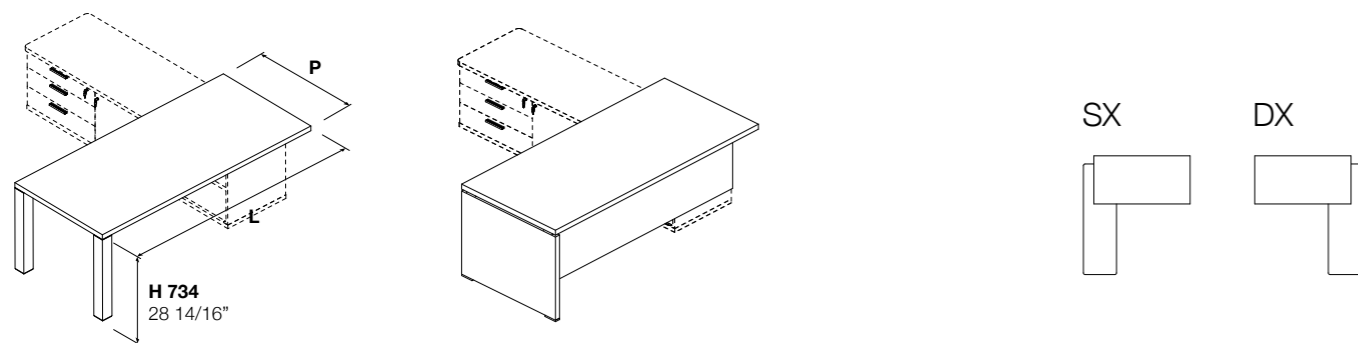

	<b>L 1800</b>   70 14/16"	<b>L 2000</b>   78 12/16"			
<b>P 900</b>   35 7/16"	•	•			

**/dattilo agganciati e indipendenti** | hanging and freestanding returns | retours accrochés et indépendants | alas suspendidas y independientes

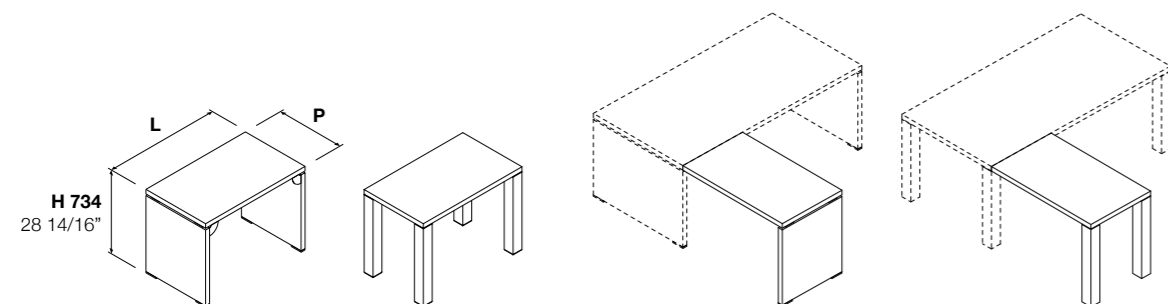

	<b>L 1000</b>   39 6/16"	<b>L 1200</b>   47 4/16"			
<b>P 600</b>   23 10/16"	•	•			

**/briefing** | briefing | briefing | briefing

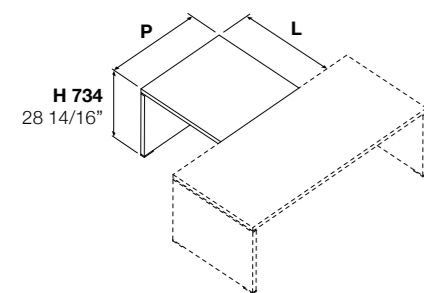

	<b>L 900</b>   35 7/16"	<b>L 1800</b>   70 14/16"			
<b>P 800</b>   31 8/16"	•				
<b>P 900</b>   35 7/16"		•			

**/tavoli quadrati e rotondi con basamento metallico** | square and round tables with metal base | tables carrées et rondes avec base en métal | mesas cuadradas y redondas con base de metal

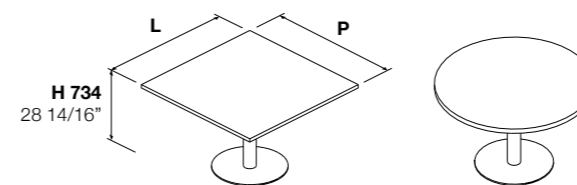

<b>L/P 800</b>   31 8/16"	<b>L/P 900</b>   35 7/16"	<b>L/P 1000</b>   39 6/16"	<b>L/P 1200</b>   47 4/16"		
•	•	•	•		

**/tavoli riunione quadrati** | square meeting tables | tables de réunion carrées | mesas de juntas cuadradas

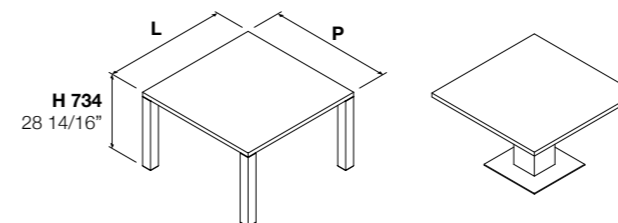

<b>L/P 800</b>   31 8/16"	<b>L/P 900</b>   35 7/16"	<b>L/P 1000</b>   39 6/16"	<b>L/P 1200</b>   47 4/16"	<b>L/P 1300</b>   51 3/16"	<b>L/P 1500</b>   59 1/16"
•	•	•	•	•	•

**/tavoli riunione** | meeting tables | tables de réunion | mesas de juntas

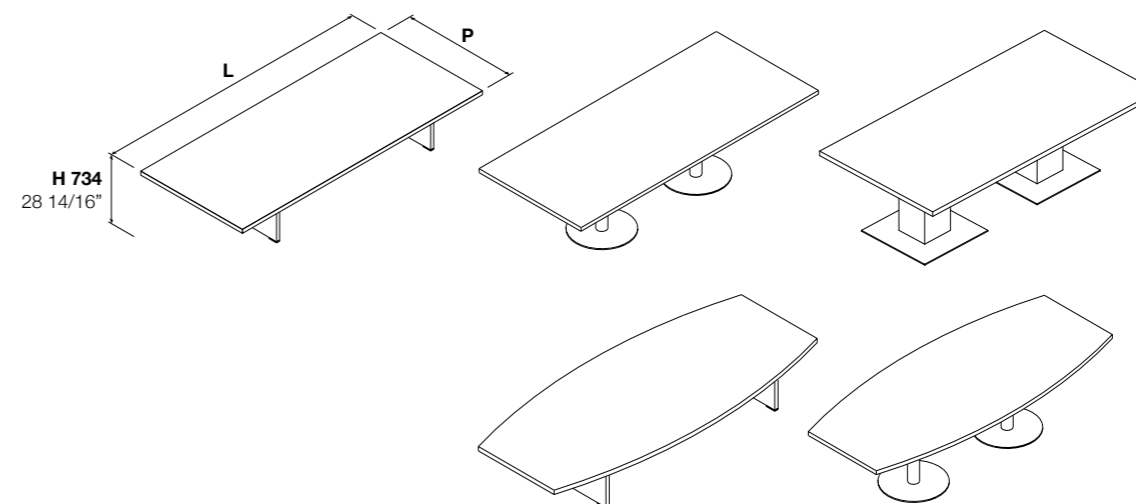

	<b>L 2100</b>   82 11/16"	<b>L 2800</b>   110 4/16"			
<b>P 1200</b>   47 4/16"	•	•			

**/tavoli riunione** | meeting tables | tables de réunion | mesas de juntas

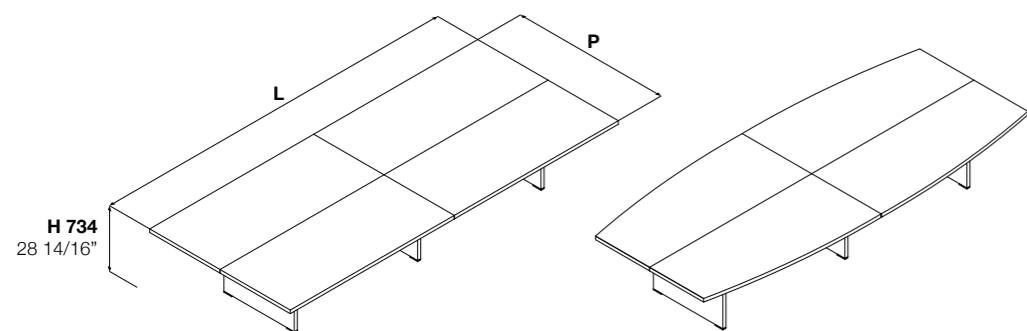

	<b>L 4200</b>   165 6/16"				
<b>P 1800</b>   70 14/16"	•				

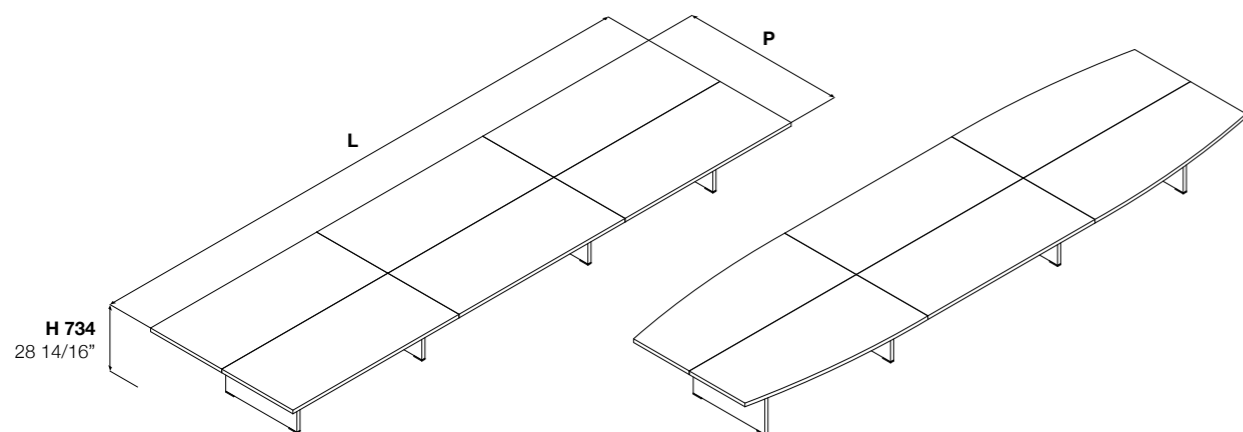

	<b>L 4900</b>   192 15/16"	<b>L 5600</b>   220 8/16"	<b>L 6300</b>   248"		
<b>P 1800</b>   70 14/16"	•	•	•		

**/tavolini da caffè** | coffee tables | tables basses | mesitas

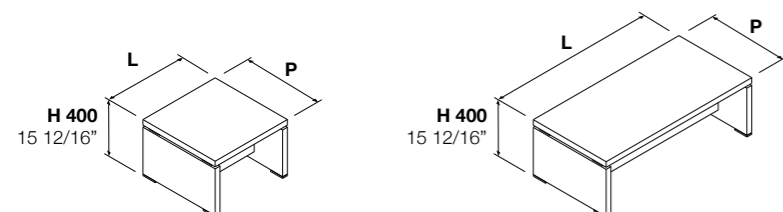

	<b>L 600</b>   35 7/16"	<b>L 1200</b>   47 4/16"			
<b>P 600</b>   31 8/16"	•	•			

**mobile di servizio fisso** | freestanding service unit | meuble retour fixe sur patins | mueble auxiliar con pies

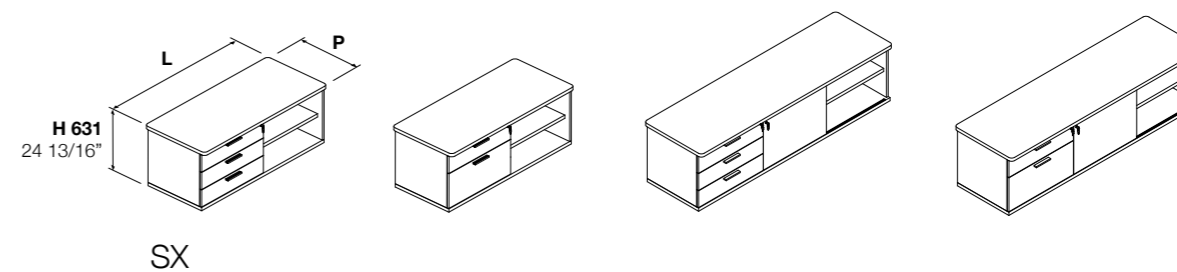

	<b>L 1385</b>   54 8/16"	<b>L 1800</b>   70 14/16"	<b>L 2067</b>   81 6/16"		
<b>P 598</b>   23 9/16"	•	•	•		

**Mobili di servizio su ruote** | mobile service unit with casters | meuble retour mobile sur roulettes | armarios con ruedas

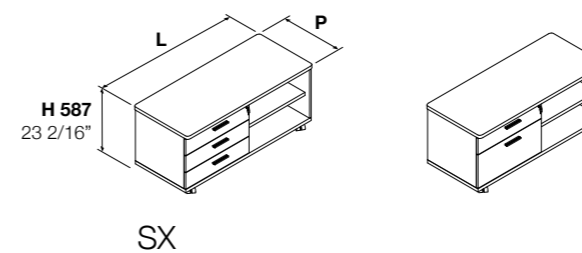

	<b>L 1385</b>   54 8/16"				
<b>P 598</b>   23 9/16"	•				









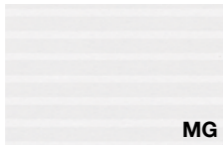
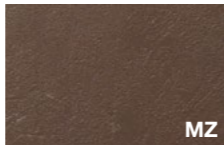

# Finiture | Finishes | Finitions | Acabados

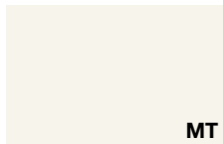
## MEL

### Melaminico

Melamine | Mélaminé | Melaminico

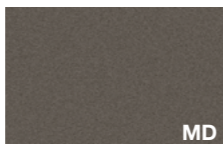
TOP MOB MOD

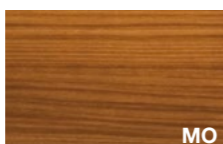
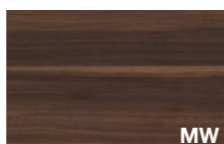



 <b>MB</b>	 <b>MG</b>	 <b>MF</b>	 <b>MZ</b>	 <b>MN</b>
<b>Bianco rigato</b> Rippled effect white Blanc avec rayures en sérigraphie Blanco rayado	<b>Grigio rigato</b> Rippled effect grey Gris avec rayures en sérigraphie Gris rayado	<b>Nichel</b> Nickel Nickel Niquel	<b>Cacao</b> Cocoa Cacao Cacao	<b>Bianco</b> White Blanc Blanco
 <b>MT</b>	 <b>MJ</b>	 <b>MK</b>	 <b>MI</b>	 <b>MV</b>
<b>Talco</b> Talco Talco Talco	<b>Ocra</b> Ochre Ocre Ocre	<b>Safari</b> Safari Safari Safari	<b>Noisette</b> Noisette Noisette Noisette	<b>Verde</b> Green Vert Verde
 <b>ML</b>	 <b>MQ</b>	 <b>MD</b>	 <b>MC</b>	 <b>MY</b>
<b>Nero</b> Black Noir Negro	<b>Blu notte</b> Night blue Bleu nuit Azul noche	<b>Ardesia</b> Ardesia Ardesia Pizarra	<b>Rovere chiaro</b> Light oak Chêne clair Roble claro	<b>Rovere americano</b> American oak Chêne américain Roble americano
 <b>ME</b>	 <b>MM</b>	 <b>MO</b>	 <b>MW</b>	
<b>Rovere grigio</b> Grey oak Chêne gris Roble gris	<b>Rovere moro</b> Dark oak Chêne foncé Roble oscuro	<b>Noce Canaletto</b> Canaletto Walnut Noyer Canaletto Nogal Canaletto	<b>Noce scuro</b> Dark walnut Noyer foncé Nogal oscuro	

## LGN

### Legno

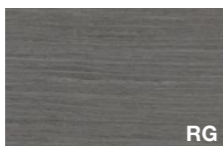
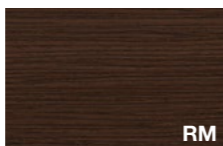
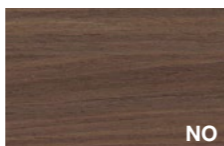
Wood | Bois | Madera

TOP MOB MOD









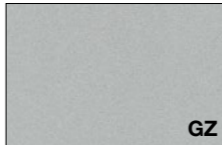

 <b>RC</b>	 <b>RG</b>	 <b>RM</b>	 <b>NO</b>	 <b>SL</b>
<b>Rovere chiaro</b> Light oak Chêne clair Roble claro	<b>Rovere grigio fumo</b> Smoke grey oak Chêne gris de fumée Roble gris humo	<b>Rovere moro</b> Dark oak Chêne foncé Roble oscuro	<b>Noce Canaletto</b> Canaletto walnut Noyer Canaletto Nogal Canaletto	<b>Ebano silver</b> Silver ebony Ebony silver Ebano plata
 <b>AK</b>	 <b>NT</b>			
<b>Ebano Makassar</b> Makassar ebony Ebony Makassar Ebano Makassar	<b>Noce termocotto</b> Heat-treated walnut Noyer thermo traité Nogal termotratado			

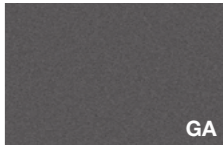
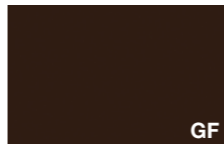
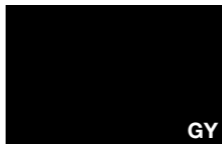
## VTR

### Vetro (anche antimpronta NFG)

Glass (also antifinger NFG) | Verre (également antitaches) | Vidrio (también anti-huella)

TOP

 <b>GW</b>	 <b>GZ</b>	 <b>GK</b>	 <b>GN</b>	 <b>GA</b>
<b>Bianco</b> White Blanc Blanco	<b>Argento</b> Silver Argent Plata	<b>Grigio scuro</b> Dark grey Gris foncé Gris oscuro	<b>Noisette</b> Noisette Noisette Noisette	<b>Ardesia</b> Ardesia Ardesia Pizarra
 <b>GF</b>	 <b>GY</b>	 <b>GX</b>	 <b>GQ</b>	 <b>GO</b>
<b>Moka</b> Mocha Moka Café	<b>Nero</b> Black Noir Negro	<b>Arancione</b> Orange Orange Naranja	<b>Rosso "F"</b> Red "F" Rouge "F" Rojo "F"	<b>Rubino</b> Ruby Rubis Rubi
 <b>GD</b>	 <b>GT</b>	 <b>GU</b>	 <b>GR</b>	
<b>Indaco</b> Indigo Indigo Azul Indigo	<b>Azzurro</b> Blue Bleu Azul	<b>Verde</b> Green Vert Verde	<b>Cedro</b> Lime green Vert Cédtrat Verde Cedro	

## GRES

### Gres porcellanato

Porcelain tiles | Grès cérame | Gres porcelánico

TOP

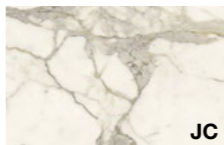
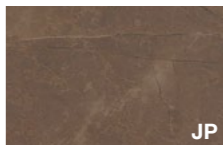
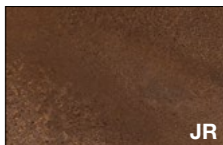
 <b>JN</b>	 <b>JB</b>	 <b>JC</b>	 <b>JP</b>	 <b>JR</b>
<b>Nero</b> Black Noir Negro	<b>Basalt</b> Basalt Basalt Basalt	<b>Calacatta</b> Calacatta Calacatta Calacatta	<b>Pulpis</b> Pulpis Pulpis Pulpis	<b>Corten</b> Corten Corten Corten



## CUO

### Cuoio

Leather | Cuir | Cuero

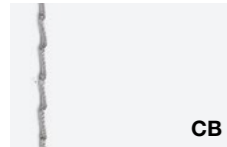

**Bianco**  
White  
Blanc  
Blanco



**Alluminio**  
Aluminium  
Aluminium  
Aluminio



**Nero**  
Black  
Noir  
Negro



**Testa di moro**  
Brown  
Tete de maure  
Marron oscuro



**Caramello**  
Caramel  
Caramel  
Caramelo



**Arancione**  
Orange  
Orange  
Naranja

TOP

## EPX

### Epossidico

Epoxy | Époxy | Epoxi



**Bianco**  
White  
Blanc  
Blanco

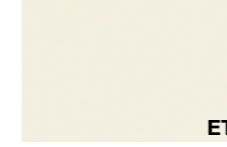

**Talco**  
Talco  
Talco  
Talco

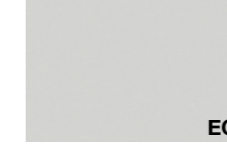

**Grigio**  
Grey  
Gris  
Gris

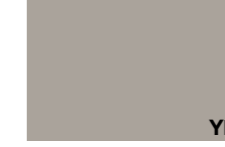

**Beige Arizona**  
Arizona beige  
Beige Arizona  
Beige Arizona



**Noisette**  
Noisette  
Noisette  
Noisette



**Safari**  
Safari  
Safari  
Safari

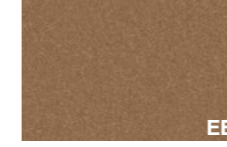

**Rame**  
Copper  
Cuivre  
Cobre

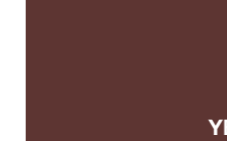

**Rosso Jaipur**  
Jaipur red  
Rouge Jaipur  
Rojo Jaipur

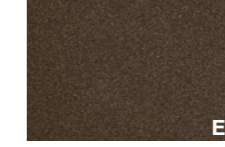

**Bronzo**  
Bronze  
Bronze  
Bronze



**Blu notte**  
Night blue  
Bleu nuit  
Azul noche



**Grigio Bromo**  
Bromo grey  
Gris Bromo  
Gris Bromo

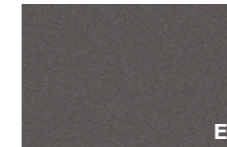

**Ardesia**  
Ardesia  
Ardesia  
Pizarra



**Verde Comodoro**  
Comodoro green  
Vert Comodoro  
Verde Comodoro



**Nero**  
Black  
Noir  
Negro

PR

STRU

## BR

### Alluminio

Aluminium | Aluminium | Aluminio



**Brill**  
Brill  
Brill  
Brill

PR

## Applicazioni finiture

Finish application | Application finitions | Aplicacion acabados



**Piano**  
Top  
Plateau  
Sobre



**Modesty panel**  
Modesty panel  
Voile de fond  
Faldón



**Mobile di servizio**  
Service unit  
Meuble de service  
Mueble de servicio



**Struttura**  
Structure  
Structure  
Structura



**Profilo scrivania**  
Top edge  
Chant plateau  
Perfil sobre de mesa

**Concept, visual & graphic design**

Alea marketing + communication

**Design**

Mirto Antonel

**Art direction**

Mirto Antonel

**Si ringrazia M.artedesign**

[martedesign.it](http://martedesign.it)

AD/CACD/AD

**alea**  
aleaoffice.com



**GLOBAL HEADQUARTERS AND SHOWROOM** : Via Col de Rust, 19 - 33070 Sarone (PN) - Italia : Tel ++39 0434 777 333  
email: info@aleaoffice.com **PARIS SHOWROOM** : 176 Avenue Charles de Gaulle 92200, Neuilly-sur-Seine - France **NORTH AMERICAN  
HEADQUARTERS** : Midtown 2, 3449 NE 1st Avenue L-32, Miami, FL 33137 - USA : Tel ++1 305 470 1200 - email: info@alea-usa.com  
**ALEA UK OFFICE AND SHOWROOM** : 50-54 Clerkenwell Road, London EC1M 5PS - email: info@aleaoffice.com