

:seating
SOLUTIONS

alea

catalogue

table of contents

02
Task

34
Managerial

58
Executive

86
Visitor

96
Hybrid

104
Community

120
Sofà

task

Le sedute “task” o operative assicurano i massimi livelli di durevolezza ed ergonomicità. Comode, funzionali e dallo stile essenziale, queste sono pensate per tutte le figure operative che spendono la maggior parte della loro giornata alla scrivania.

Queste sedie sono progettate per garantire una corretta postura del corpo, grazie all’ausilio di supporti lombari e schienali regolabili. Alla postazione di lavoro assicurano stabilità e piena sicurezza.

“Task” chairs ensure the highest levels of durability and ergonomics. Comfortable, functional and with an essential design, they are intended for professionals who spend most of their day at the desk.

These chairs are designed to ensure correct body posture with the aid of lumbar supports and height adjustable backrests. They provide stability and complete safety at work.

Les assises “task” ou opérationnelles garantissent les plus hauts niveaux de durabilité et d’ergonomie. Confortables, fonctionnels et au design essentiel, ils sont destinés aux professionnels qui passent la majeure partie de leur journée au bureau.

Ces chaises sont conçues pour assurer une posture correcte du corps grâce à des supports lombaires et des dossiers réglables en hauteur. Au poste de travail assure la stabilité et la sécurité totale.

Las sillas “task” o de trabajo garantizan los más altos niveles de durabilidad y ergonomía. Cómodas, funcionales y con un diseño esencial, están pensadas para los profesionales que pasan la mayor parte del día en el escritorio.

Estas sillas están diseñadas para garantizar una postura corporal correcta con la ayuda de soportes lumbares y respaldos regulables en altura. Garantizan estabilidad y total seguridad en el puesto de trabajo.

04
T10

10
T30

16
T35

20
T50

28
T70

T10



T10 è una sedia operativa caratterizzata da linee semplici e pulite, perfetta per un utilizzo intensivo e professionale.

T10 is a task chair with clean and essential lines, perfect for intensive and professional use.

T10 est une chaise opérative caractérisée par des lignes simples et propres, parfaite pour usage intensif et professionnel.

T10 es una silla de trabajo caracterizada por líneas simples y limpias, perfecta para un uso intensivo y profesional.

Il comodo schienale
in rete presenta
un supporto lombare
regolabile di
colore nero.



2.

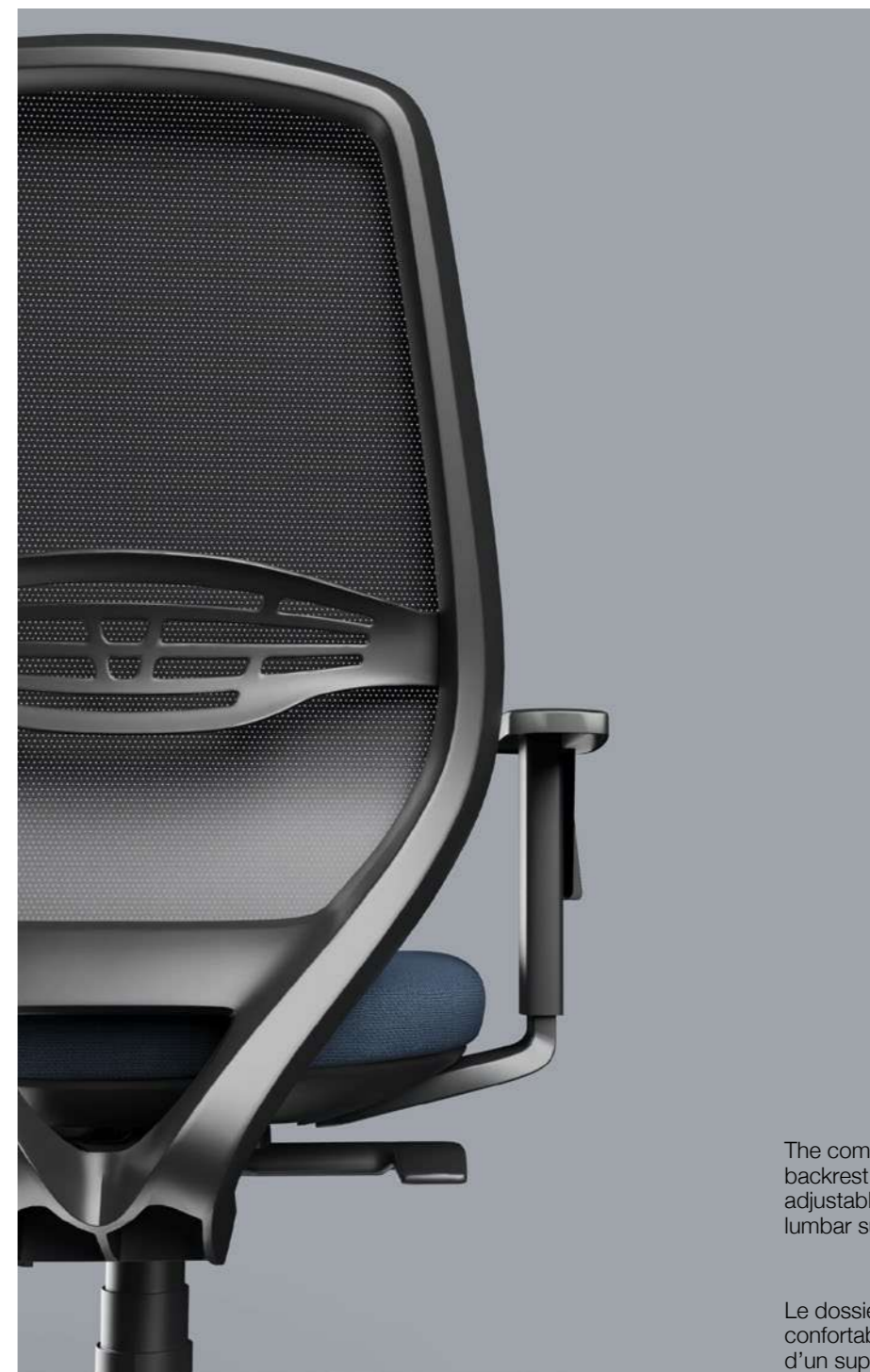

The comfortable mesh
backrest is fitted with an
adjustable black
lumbar support.

Le dossier en maille
confortable est équipé
d'un support lombaire
noir réglable.

El cómodo respaldo de
malla está provisto
de un soporte lumbar
negro ajustable.

Varianti | Variants | Variantes | Variantes

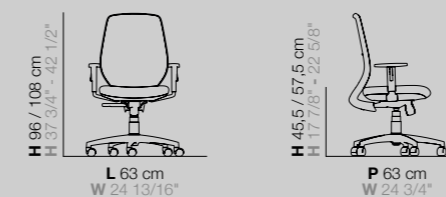

Finiture | Finishes | Finitions | Acabados

		STD	
Struttura Frame Structure Estructura	→		
Base Base Base Base	→		
Supporto lombare Lumbar support Soutien lombaire Apoyo lumbar	→		
			Rivestimento sedile Seat upholstery Revêtement de siège Revestimiento del asiento
			→
			Rivestimento schienale Backrest upholstery Revêtement du dossier Revestimiento del respaldo
			→

Mix & match

Varianti Variants Variantes Variantes	Schienali Backrests Dossier Respaldos	Meccanismi Mechanisms Mécanismes Mecanismos	Bracciali Adjustable Accoudoirs Reposabrazos	Colori struttura e base Frame and base colours Couleurs base et structure Colores base y estructura	Rivestimento sedile Seat upholstery Revêtement de siège Revestimiento del asiento



3.

1. PT10DRS1AA
Rivestimento | Upholstery | Revêtement | Revestimiento - STANDARD 8009

2. PT10DRA1AA
Rivestimento | Upholstery | Revêtement | Revestimiento - CURA.GABRIEL 66170

3. PT10DRA1AA | PT10DRA1AA | PT10DRA2AD
Rivestimento | Upholstery | Revêtement | Revestimiento - JET.FIDIVI 9703 - JET.FIDIVI 9804 - JET.FIDIVI 9601

T30



T30 è una sedia operativa che fa della comodità ed dell'ergonomicità i suoi punti di forza. Ideale per un uso quotidiano e prolungato grazie alle numerose possibilità di declinazione disponibili.

T30 is a task chair that makes comfort and ergonomics its strengths. It is ideal for daily and extended use, thanks to the various declinations available.

T30 est une chaise opérative qui fait du confort et de l'ergonomie sa force. Elle est idéale pour une utilisation quotidienne et prolongée grâce aux plusieurs possibilités de déclinaison.

T30 es una silla de trabajo cuyos puntos fuertes son comodidad y manejo ergonómico. Ideal para el utilizzo diario y prolongado, gracias a las numerosas posibilidades de uso.

1.

Lo schienale può essere in rete o rivestito in tessuto, è regolabile in altezza e include un supporto lombare.



2.



The backrest is available in mesh or fabric, is adjustable in height and can be fitted with a lumbar support.

Le dossier est conçu en résille ou en tissu, il est réglable en hauteur et il est équipé d'un support lombaire.

El respaldo, que puede ser en malla o tapizado, es ajustable en altura y cuenta con un apoyo lumbar.



3.

1. PT30CRS1AD
Rivestimento | Upholstery | Revêtement | Revestimiento - STANDARD 8009

2. PT30CRA4AD
Rivestimento | Upholstery | Revêtement | Revestimiento - JET.FIDIVI 9703

3. PT30ARA1AD | PT30CRA4AD
Rivestimento | Upholstery | Revêtement | Revestimiento - JET.FIDIVI 9294 - JET.FIDIVI 9601

Varianti | Variants | Variantes | Variantes



T30

Finiture | Finishes | Finitions | Acabados

		STD			
Struttura Frame Structure Estructura	→			Rivestimento sedile Seat upholstery Revêtement de siège Revestimiento del asiento	→
Base Base Base Base	→			Rivestimento schienale Backrest upholstery Revêtement du dossier Revestimiento del respaldo	→
Supporto lombare Lumbar support Soutien lombaire Apoyo lumbar	→			Rivestimento poggiatesta Headrest upholstery Revêtement de l'appui-tête Revestimiento del reposacabezas	→

Mix & match

Varianti Variants Variantes Variantes	Schienali Backrests Dossier Respaldos	Meccanismi Mechanisms Mécanismes Mecanismos	Braccioli Adjustable Accoudoirs Reposabrazos	Colori struttura e base Frame and base colours Couleurs base et structure Colores base y estructura	Rivestimento seduta Seat upholstery Revêtement de siège Revestimiento del asiento

T35



T35 è una sedia operativa elegante e moderna, adatta a offrire comfort e relax ai professionisti che trascorrono molte ore alla scrivania.

T35 is an elegant and modern task chair, perfect for providing comfort and relaxation to professionals who spend many hours at their desks.

T35 est une chaise de travail élégante et moderne, parfaite pour offrir confort et détente aux professionnels qui passent nombreuses heures au bureau.

T35 es una silla de trabajo elegante y moderna, adecuada para ofrecer confort y relax a los profesionales que pasan muchas horas en el escritorio.

1.

È dotata di un supporto lombare regolabile in altezza.

It features a lumbar support adjustable in height.

Le support lombaire est intégré et réglable en hauteur.

El apoyo lumbar está integrado y es ajustable en altura.

Varianti | Variants | Variantes | Variantes

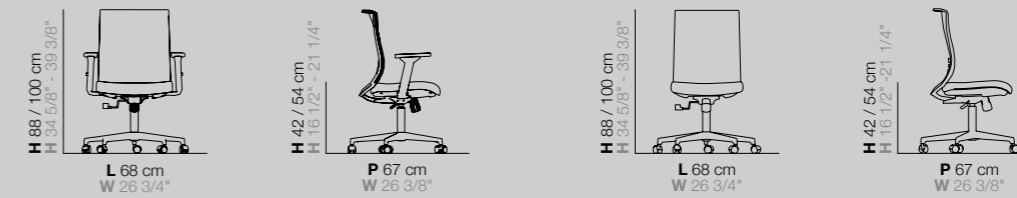

T35

Finiture | Finishes | Finitions | Acabados

	STD		
Struttura Frame Structure Estructura	→		
Base Base Base Base	→		
Supporto lombare Lumbar support Soutien lombaire Apoyo lumbar	→		
			Rivestimento sedile Seat upholstery Revêtement de siège Revestimiento del asiento
			→
			Rivestimento schienale Backrest upholstery Revêtement du dossier Revestimiento del respaldo
			→

Mix & match

Varianti Variants Variantes Variantes	Schienali Backrests Dossier Respaldos	Meccanismi Mechanisms Mécanismes Mecanismos	Braccioli Adjustable Accoudoirs Reposabrazos	Colori struttura e base Frame and base colours Couleurs base et structure Colores base y estructura	Rivestimento seduta Seat upholstery Revêtement de siège Revestimiento del asiento

1. PT35DRS1AB
Rivestimento | Upholstery | Revêtement | Revestimiento - STANDARD 8033

2. PT35DRS1AB
Rivestimento | Upholstery | Revêtement | Revestimiento - STANDARD 8033



T50



T50

T50 è una seduta che si distingue per linee arrotondate e morbide, perfetta per ambienti dal carattere dinamico ed innovativo.

T50 is a chair distinguished by its smooth and soft lines, well suited to environments with a dynamic and innovative character.

T50 est une chaise qui se distingue par des lignes arrondies et douces, parfaite pour les environnements avec un caractère dynamique et innovant.

T50 es una silla que destaca por líneas redondeadas y suaves, perfecta para ambientes de carácter dinámico e innovador.



La sedia presenta un supporto lombare regolabile in altezza caratterizzato da un'originale forma ovale.

The chair features a height-adjustable lumbar support characterised by an original oval shape.

Le T50 est doté d'un support lombaire réglable en hauteur et il se caractérise par une forme ovale originale.

T50 ofrece un apoyo lumbar ajustable en altura caracterizado por una original forma oval.







4.

1. PT50BRS1AD

Rivestimento | Upholstery | Revêtement | Revestimiento - STANDARD 8009

2. PT50BRA1AD

Rivestimento | Upholstery | Revêtement | Revestimiento - CURA.GABRIEL 61258

3. PT50BRA1AD

Rivestimento | Upholstery | Revêtement | Revestimiento - JET.FIDIVI 9703

4. PT50ARA1AH | PT50BRA1AD

Rivestimento | Upholstery | Revêtement | Revestimiento - CURA.GABRIEL 61168 - CURA.GABRIEL 61258

Varianti | Variants | Variantes | Variantes

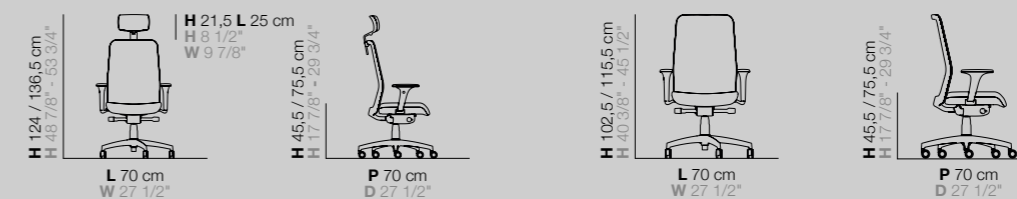

Finiture | Finishes | Finitions | Acabados

		STD			
Struttura Frame Structure Estructura	→			Rivestimento sedile Seat upholstery Revêtement de siège Revestimiento del asiento	→
Base Base Base Base	→			Rivestimento schienale Backrest upholstery Revêtement du dossier Revestimiento del respaldo	→
Supporto lombare Lumbar support Soutien lombaire Apoyo lumbar	→			Rivestimento poggiatesta Headrest upholstery Revêtement de l'appui-tête Revestimiento del reposacabezas	→

Mix & match

Varianti Variants Variantes Variantes	Schienali Backrests Dossier Respaldos	Meccanismi Mechanisms Mécanismes Mecanismos	Braccioli Adjustable Accoudoirs Reposabrazos	Colori struttura e base Frame and base colours Couleurs base et structure Colores base y estructura	Rivestimento seduta Seat upholstery Revêtement de siège Revestimiento del asiento

T70



T70 è una sedia full-mesh che si distingue dalle altre sedute operative per il suo design moderno e ricercato.

T70 is a full-mesh task chair that stands out from the others for its modern and sophisticated design.

T70 est une chaise entièrement en résille qui se distingue des autres chaises opératives pour son design moderne et recherché.

T70 es una silla totalmente en malla, que destaca para su diseño moderno y sofisticado.



Lo schienale e la seduta sono in rete autoportante, elastica, traspirante e resistente.



2.

The backrest and seat are in self-supporting, breathable and resistant technical mesh.

Le dossier et l'assise sont en résille autoportante, élastique, transpirante et résistante.

Respaldo y asiento son en malla autoportante, elástica, transpirable y duradera.



3.

1. PT70ARS3AG
Rivestimento | Upholstery | Revêtement | Revestimiento - STANDARD BL

2. PT70ARS3AG
Rivestimento | Upholstery | Revêtement | Revestimiento - STANDARD BL

3. PT70ARS3AG | PT70CRS3AG
Rivestimento | Upholstery | Revêtement | Revestimiento - STANDARD BL

Varianti | Variants | Variantes | Variantes



Finiture | Finishes | Finitions | Acabados

STD

Struttura Frame Structure Estructura	→ ●	Rivestimento sedile Seat upholstery Revêtement de siège Revestimiento del asiento	→ ○ RET
Supporto lombare Lumbar support Soutien lombaire Apoyo lumbar	→ ●	Rivestimento schienale Backrest upholstery Revêtement du dossier Revestimiento del respaldo	→ ○ RET

Poggiatesta in PU rivestito in similpelle nera
PU headrest upholstered in black faux leather
Appui-tête en PU recouvert de faux-cuir noir
Reposacabeza en PU tapizado en eco piel negra

Mix & match

○ 2	○ 1	○ 2	○ 1	○ 1
Varianti Variants Variantes Variantes	Seduta Seat Assise Asiento	Meccanismi Mechanisms Mécanismes Mecanismos	Braccioli Adjustable Accoudoirs Reposabrazos	Colori struttura e base Frame and base colours Couleurs base et structure Colores base y estructura

managerial

Le sedute “managerial” o manageriali sono una linea con una duplice importante valenza: garantire un alto livello di rappresentatività, particolarmente in contesti di incontro con persone esterne all’azienda, e assicurare il comfort per un utilizzo prolungato durante la giornata.

Questa linea è pensata per le figure direzionali. Le forme impiegate sono contemporanee ed ergonomiche, mettendo la funzionalità al primo posto senza rinunciare alla qualità e all’attenzione per i dettagli.

“Managerial” chairs are a line with a dual value. They ensure a high level of representativeness (particularly for meetings with people from outside the company) and, at the same time, provide comfort for extended use throughout the day.

This category of seats is intended for management profiles. The lines are comfortable and ergonomic, prioritising functionality without compromising on quality of detail.

Les “managerial” ou de gestion sont une ligne de assises avec un double valeur: garantir un haut niveau de représentativité, en particulier pour réunion avec clients, en même temps, confort pour une utilisation prolongée au cours de la journée.

Cette ligne est conçue pour figures directionnelles. Les lignes sont confortables et ergonomiques, privilégiant la fonctionnalité sans compromettre la qualité des détails.

Las sillas “managerial” o gerenciales son una línea con un doble valor importante: garantizan un alto nivel de representatividad, sobre todo en contextos de reunión con personas ajenas a la empresa, y al mismo tiempo comodidad para un uso prolongado a lo largo del día.

Esta línea está pensada para las figuras directivas. Las líneas son cómodas y ergonómicas, y dan prioridad a la funcionalidad sin renunciar a la calidad de los detalles.

36
M10

44
M30

50
M50

M10



1.

M10 è una sedia manageriale dai tratti leggeri ed eleganti, una perfetta fusione tra stile e comfort.



M10 is a managerial chair with light and elegant features that perfectly combines style and comfort.

M10 est une chaise mangériale avec traits légers et élégants, une parfaite fusion de style et de confort.

M10 es una silla gerencial con características ligeras y elegantes, una fusión perfecta de estilo y comodidad.



Nel sinuoso schienale,
in rete o rivestito in
tessuto, è integrato
un ergonomico
supporto lombare
regolabile in altezza.

2.

M10



The sinuous backrest is
available in mesh or fabric
and features an ergonomic,
height-adjustable
lumbar support.

Le sinueux dossier en
résille ou en tissu est
équipé d'un support
lombaire ergonomique
réglable en hauteur.

En el sinuoso respaldo,
en malla o tapizado,
se incorpora un apoyo
lumbar ergonómico,
ajustable en altura.



1. PM10ATC3DG

Rivestimento | Upholstery | Revêtement | Revestimiento - ACTON.VESCOM 7062.11

2. PM10BTA1AG

Rivestimento | Upholstery | Revêtement | Revestimiento - CURA.GABRIEL 62083

3. PM10BTA1AB | PM10DTB1AG | PM10ATB3DG | PM10DTA9LV | PM10DRS1LV

Rivestimento | Upholstery | Revêtement | Revestimiento

CURA.GABRIEL 62083 - GO CHECK.GABRIEL 61145 - GO UNI.GABRIEL 66139 - CURA.GABRIEL 68182 - STANDARD 8033

4. PM10BTA1AG | PM10BRS1AG

Rivestimento | Upholstery | Revêtement | Revestimiento - CURA.GABRIEL 62083 - STANDARD 8033



Varianti | Variants | Variantes | Variantes

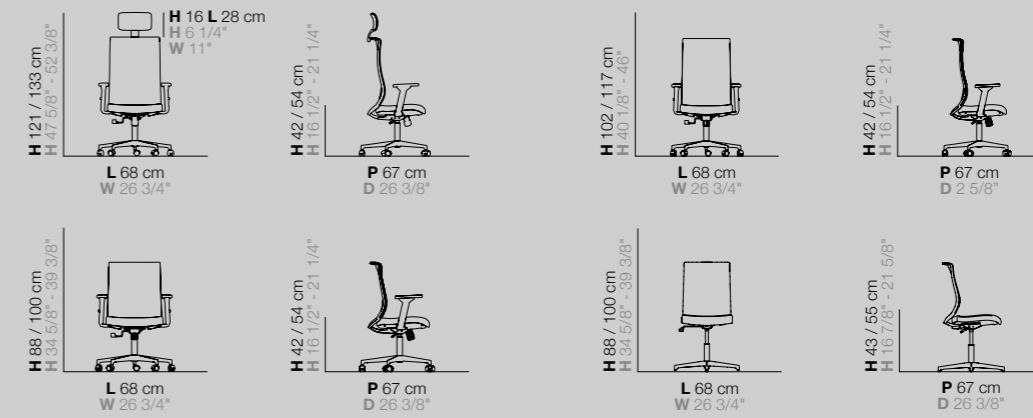

M10

Finiture | Finishes | Finitions | Acabados

	STD	STD			
Struttura Frame Structure Estructura	→	/		Rivestimento sedile Seat upholstery Revêtement de siège Revestimiento del asiento	→
Base Base Base Base	→			Rivestimento schienale Backrest upholstery Revêtement du dossier Revestimiento del respaldo	→
Supporto lombare Lumbar support Soutien lombaire Apoyo lumbar	→	/		Rivestimento poggiatesta Headrest upholstery Revêtement de l'appui-tête Revestimiento del reposacabezas	→

Mix & match

Varianti Variants Variantes Variantes	Schienali Backrests Dossier Respaldos	Meccanismi Mechanisms Mécanismes Mecanismos	Braccioli Adjustable Accoudoirs Reposabrazos	Colori struttura Frame colours Couleurs structure Colores estructura	Colori base Base colours Couleurs base Colores base	Rivestimento seduta Seat upholstery Revêtement de siège Revestimiento del asiento

M30



1.

M30 è un'elegante sedia manageriale caratterizzata da forme ergonomiche e morbide, perfetta per un utilizzo prolungato.

M30 is an elegant executive chair with soft, ergonomic lines, perfect for prolonged use.

M30 est une chaise managériale élégante caractérisée par des formes ergonomiques et douces, parfaite pour une utilisation prolongée.

M30 es una silla gerencial que destaca por sus formas ergonómicas y suaves, idónea para su utilizzo prolongado.



**Il comodo schienale
in PU schiumato è
regolabile in altezza
e può essere
rivestito in tessuto,
pelle o similpelle.**

M30



The comfortable PU foam backrest is height-adjustable and can be upholstered in fabric, leather or faux leather.

Le dossier confortable en mousse PU, est réglable en hauteur et il peut être revêtu en tissu, cuir ou faux-cuir.

El cómodo respaldo en espuma de PU es regulable en altura y puede tapizarse en tela, cuero o eco-piel.





3.

1. PM30DTD1AH | PM30ATD1AH

Rivestimento | Upholstery | Revêtement | Revestimiento - WOLIN.VESCOM 7050.03

2. PM30BTA1AH

Rivestimento | Upholstery | Revêtement | Revestimiento - CURA.GABRIEL 68182

3. PM30DTA1AH | PM30ATA1AH | PM30BTD1AH

Rivestimento | Upholstery | Revêtement | Revestimiento - CURA.GABRIEL 66167 - JET.FIDIVI 9110 - CRISP.GABRIEL 4721

Varianti | Variants | Variantes | Variantes

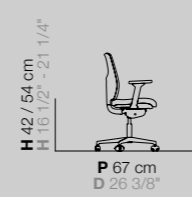
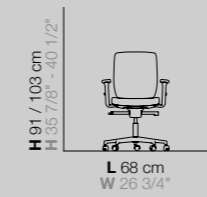
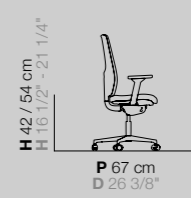
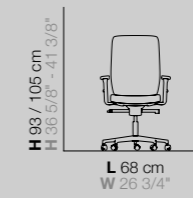
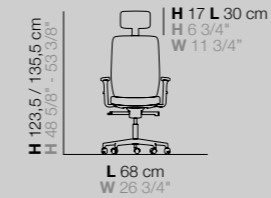

M30

Finiture | Finishes | Finitions | Acabados

	STD	STD	
Struttura Frame Structure Estructura	→	/	
Base Base Base Base	→		

Rivestimento sedile Seat upholstery Revêtement de siège Revestimiento del asiento	→	
---	---	--

Rivestimento schienale Backrest upholstery Revêtement du dossier Revestimiento del respaldo	→	
---	---	--

Rivestimento poggiatesta Headrest upholstery Revêtement de l'appui-tête Revestimiento del reposacabezas	→	
---	---	--

Mix & match

Varianti Variants Variantes	Schienali Backrests Dossier Respaldos	Meccanismi Mechanisms Mécanismes Mecanismos	Braccioli Adjustable Accoudoirs Reposabrazos	Colori struttura Frame colours Couleurs structure Colores estructura	Colori base Base colours Couleurs base Colores base	Rivestimento seduta Seat upholstery Revêtement de siège Revestimiento del asiento

M50



M50 è una sedia manageriale dal carattere deciso e dalle linee autorevoli, perfetta per ambienti eleganti e sofisticati.



M50 is a managerial chair with a strong character and authoritative lines, perfect for elegant and sophisticated environments.

M50 est une chaise mangériale avec un caractère décidé et des lignes d'autorité, parfaite pour les environnements élégants et sophistiqués.

M50 es una silla gerencial con carácter fuerte y líneas decididas, ideal para ambientes elegantes y sofisticados.



2.

**Le linee raffinate e i
dettagli tecnici
rendono la poltrona
ergonomica, comoda
e dallo stile ricercato.**

M50



Its refined lines and
technical details make it an
ergonomic, comfortable,
and sophisticated armchair.

Les lignes raffinées et les
détails techniques rendent
cette chaise ergonomique,
confortable et avec une
style recherché.

Las líneas refinadas y
los detalles técnicos, la
convierten en un sillón
ergonómico, cómodo y con
un estilo sofisticado.



3.

1. PM50ATP3AH | PM50CTP9LV
Rivestimento | Upholstery | Revêtement | Revestimiento - POLO.EFFETIGEST 0822

2. PM50CTD3AH
Rivestimento | Upholstery | Revêtement | Revestimiento - CRISP.GABRIEL 4033

3. PM50ATA7AH | PM50CTC3AH | PM50BTC3AH | PM50CTD9EV
Rivestimento | Upholstery | Revêtement | Revestimiento
SECRET.FLUKSO 1003 - ACTON.VESCOM 7062.32 - ACTON.VESCOM 7062.31 - WOLIN.VESCOM 7050.10

4. PM50CTP3AH | PM50CTD3AH
Rivestimento | Upholstery | Revêtement | Revestimiento - POLO.EFFETIGEST 0860 - CRISP.GABRIEL 4033



Varianti | Variants | Variantes | Variantes

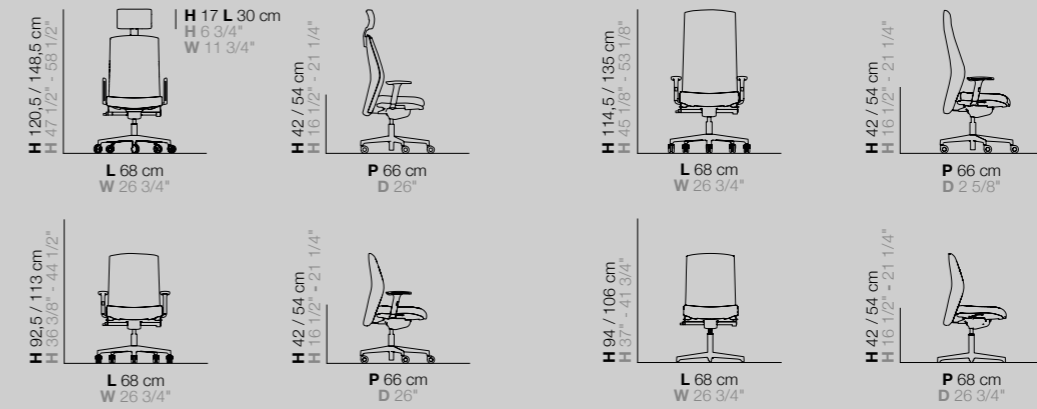

M50

Finiture | Finishes | Finitions | Acabados

	STD	STD		
Struttura Frame Structure Estructura	→ ●	/	Rivestimento sedile Seat upholstery Revêtement de siège Revestimiento del asiento	→ ● TES ● PEL
Base Base Base Base	→ ●	●	Rivestimento schienale Backrest upholstery Revêtement du dossier Revestimiento del respaldo	→ ● TES ● PEL
			Rivestimento poggiatesta Headrest upholstery Revêtement de l'appui-tête Revestimiento del reposacabezas	→ ● TES ● PEL

Mix & match

4	2	3	3	1	2	106
Varianti Variants Variantes	Schienali Backrests Dossier Respaldos	Meccanismi Mechanisms Mécanismes Mecanismos	Braccioli Adjustable Accoudoirs Reposabrazos	Colori struttura Frame colours Couleurs structure Colores estructura	Colori base Base colours Couleurs base Colores base	Rivestimento seduta Seat upholstery Revêtement de siège Revestimiento del asiento

executive

Le sedute “executive” o direzionali esprimono in modo chiaro e immediato lo stile rappresentativo e unico di un’azienda e del suo management.

Attraverso un’attenta ricerca progettuale, la qualità dei materiali utilizzati (es. pelle ed simil-pelle) e la cura di ogni minimo dettaglio, coniugano prestigio e autorevolezza, design ed efficienza, funzionalità ed ergonomia.

“Executive” chairs clearly and immediately express the representative and unique style of a company and its management.

Thanks to careful design research, quality of the materials used (e.g. leather and faux leather) and attention to even the smallest detail, they combine prestige and authority, design and efficiency, functionality and ergonomics.

Les chaises “executive” ou de direction expriment avec instantanéité et clarté la représentativité et un style distinctif d’une entreprise et ses dirigeants.

Grâce à une recherche attentive relative aux projets, la qualité des matériaux utilisés (par ex. cuir et faux-cuir) et le soin de chaque détail, allient prestige et autorité, design et efficacité, fonctionnalité et ergonomie.

Los asientos “executive” o ejecutivos expresan con inmediatez y claridad la representatividad y el estilo distintivo de una empresa y, en particular, de sus dirigentes.

La cuidadosa investigación de diseño, la calidad de los materiales utilizados, como cuero y ecopiel, y la atención a cada detalle combinan prestigio y autoridad, estética y eficiencia, funcionalidad y ergonomía.

60
E10

70
E30

78
E50

E10



E10 è una collezione di poltrone direzionali caratterizzate da linee pulite e sofisticate, perfette per uffici moderni e classici.

E10 is a collection of executive chairs characterised by clean and sophisticated lines, perfect for both modern and classic offices.

E10 est une collection de chaises qui est caractérisée par des lignes claires et sophistiquées, qui la rend polyvalente pour bureaux modernes que classiques.

E10 es una colección de asientos que se caracteriza por líneas limpias y sofisticadas, que la hacen versátil tanto para oficinas modernas como clásicas.



E10

Lo schienale può essere in rete autoportante, tessuto o in pelle. La struttura può essere cromata o verniciata su richiesta.

The backrest is available in mesh or upholstered fabric, leather or faux leather. The frame can be chrome-plated or powder-coated in a matching colour.

Le dossier est disponible en résille autoportante, ou en tissu ou en cuir. La structure peut être chromée ou vernie sur demande.

El respaldo está fabricado en malla autoportante, tela o cuero. La estructura puede cromarse o pintarse bajo pedido.

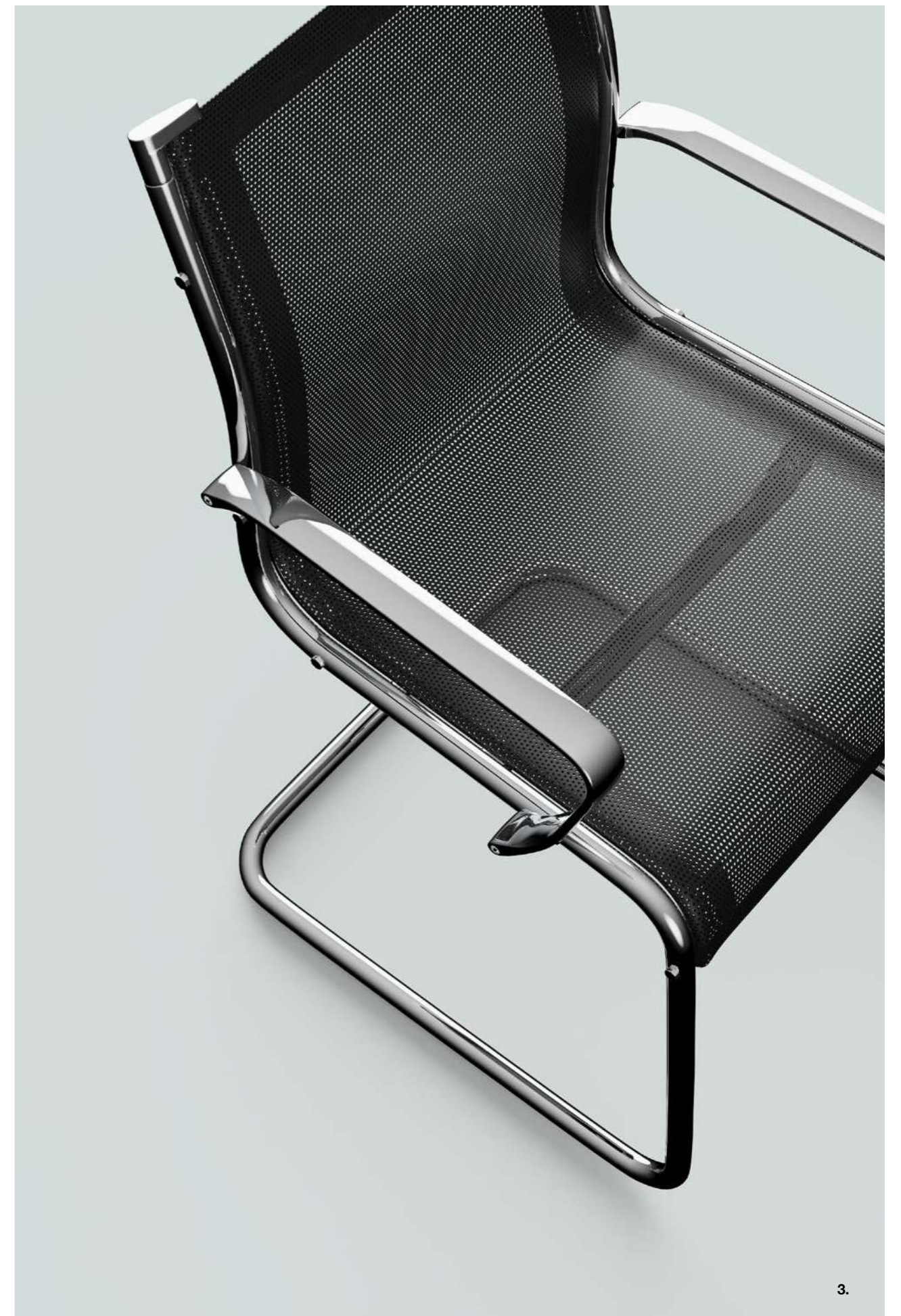





5.

1. PE10BTD7HN

Rivestimento | Upholstery | Revêtement | Revestimiento - WOLIN.VESCOM 7050.09 | NB

2. PE10BRS7DS | PE10BTC7HN

Rivestimento | Upholstery | Revêtement | Revestimiento - N00 - ACTON.VESCOM 7062.31 | DG

3. PE10DRS7FZ

Rivestimento | Upholstery | Revêtement | Revestimiento - N00

4. PE10BTC7HS

Rivestimento | Upholstery | Revêtement | Revestimiento - ACTON.VESCOM 7062.06 | WR

5. PE10DRS7FZ | PE10BTC7HS | PE10DRS7HN

Rivestimento | Upholstery | Revêtement | Revestimiento - N00 - ACTON.VESCOM 7062.31 | DG - N00

6. PE10BRS7DS | PE10BTC7HN

Rivestimento | Upholstery | Revêtement | Revestimiento - N00 - ACTON.VESCOM 7062.31 | DG

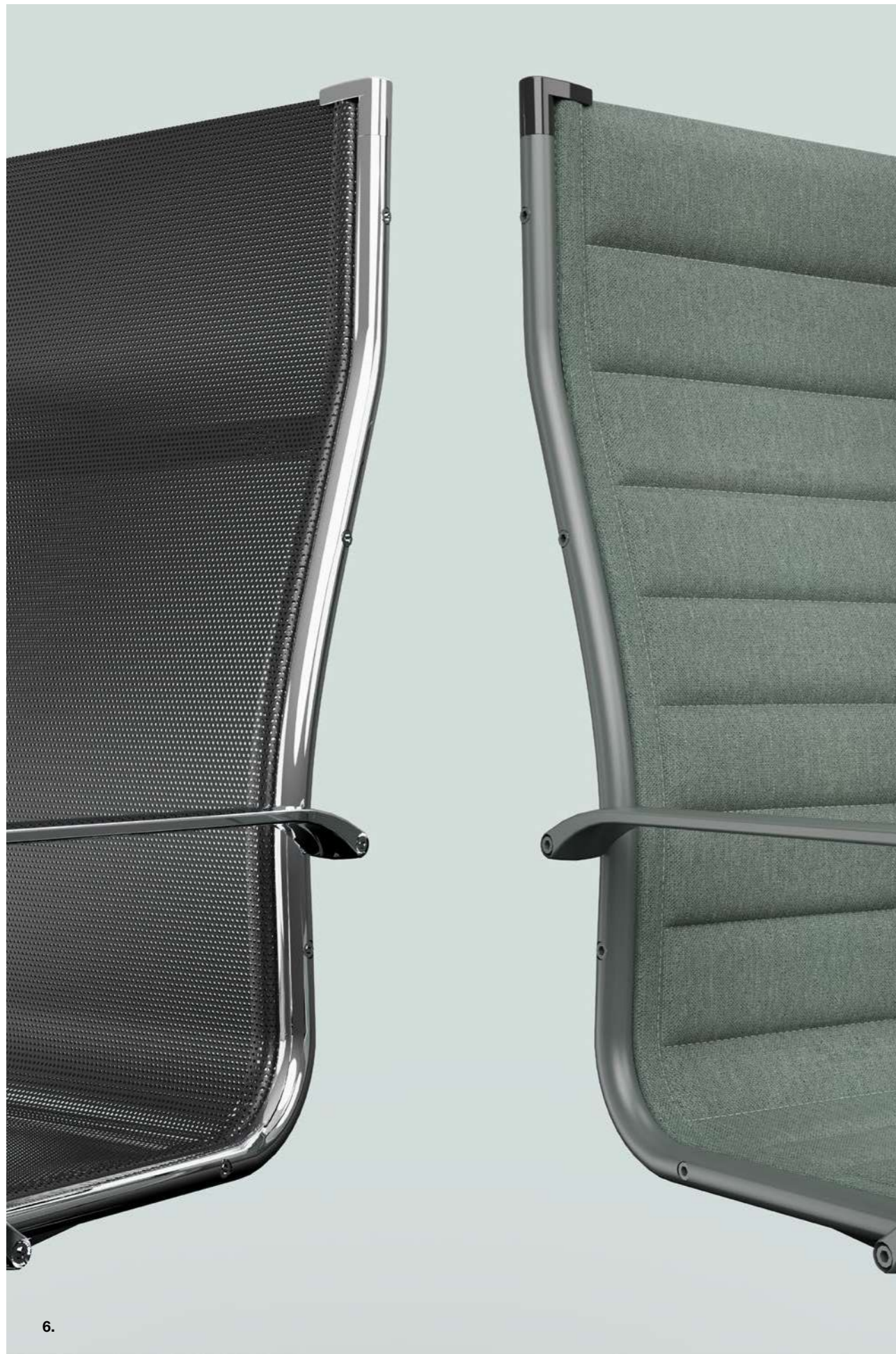

6.

Varianti | Variants | Variantes | Variantes

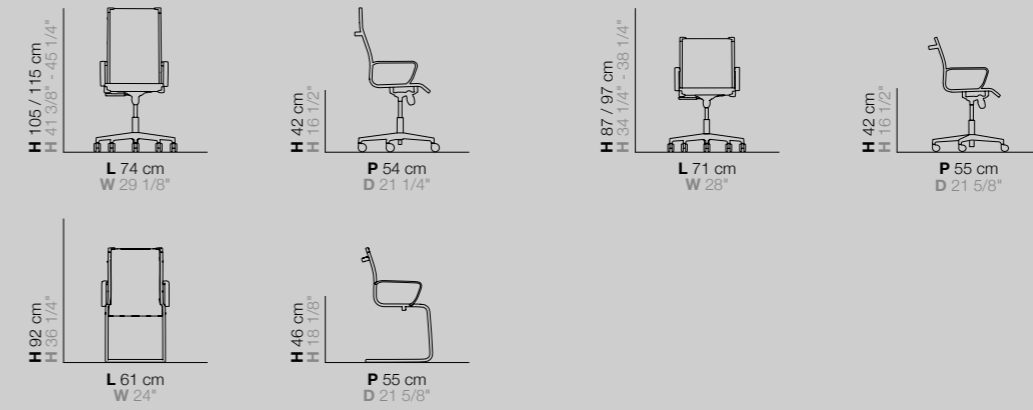

Finiture | Finishes | Finitions | Acabados

	STD	STD		
Struttura Frame Structure Estructura	→	→	→	
Base Base Base Base	→	→	→	
				Rivestimento seduta Seat upholstery Revêtement de siège Revestimiento del asiento
				→

Mix & match

Varianti Variants Variantes Variantes	Meccanismi Mechanisms Mécanismes Mecanismos	Braccioli Adjustable Accoudoirs Reposabrazos	Colori struttura e base Frame and base colours Couleurs base et structure Colores base y estructura	Rivestimento seduta Seat upholstery Revêtement de siège Revestimiento del asiento

E30

E30 si caratterizza per le linee morbide ed avvolgenti, per un design classico che dona importanza all'ambiente ufficio.



E30 is characterised by soft, enveloping lines and a classic design that enhances the office environment.

E30 se caractérise par des lignes douces et enveloppantes, pour un design classique qui donne importance à l'environnement du bureau.

E30 se caracteriza por sus líneas suaves y envolventes, para un diseño clásico que confiere importancia al entorno de oficina.

Può essere rivestita
sia in tessuto che
in pelle in base alle
esigenze del cliente.



Depending on the
customer's requirements,
it can be upholstered
in fabric, leather
or faux leather.

Elle peut être revêtue en
tissu mais aussi en
cuir selon les
exigences du client.

Puede tapizarse en
tela o cuero, según
las necesidades del cliente.





Varianti | Variants | Variantes | Variantes

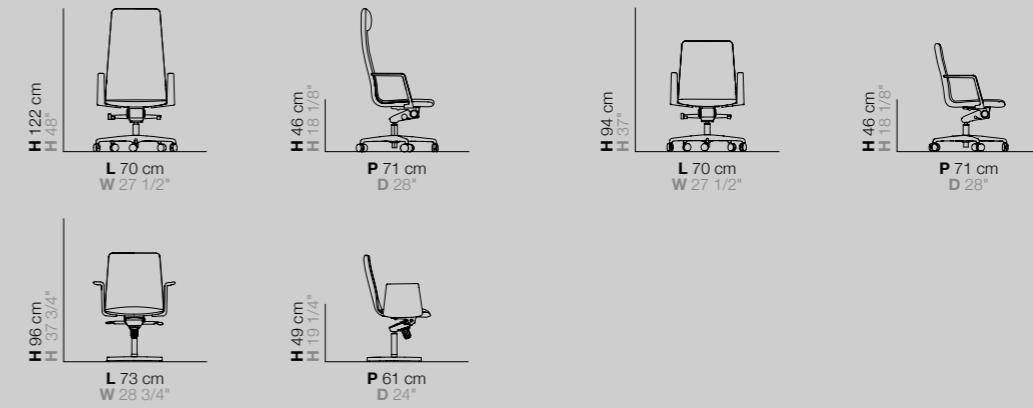

Finiture | Finishes | Finitions | Acabados

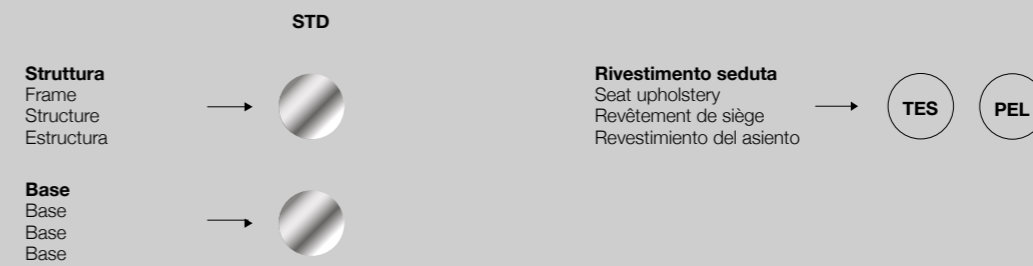

Mix & match



1. PE30BTP7DP
Rivestimento | Upholstery | Revêtement | Revestimiento - POLO.EFFETIGEST 0822

2. PE30BTP7DP
Rivestimento | Upholstery | Revêtement | Revestimiento - POLO.EFFETIGEST 0947

3. PE30BTP7DP | PE30DTC7DP | PE30BTB8DP | PE30DTC7EV
Rivestimento | Upholstery | Revêtement | Revestimiento
POLO.EFFETIGEST 0878 - PASSION.GABRIEL 16101 - GO UNI.GABRIEL 60093 - PASSION.GABRIEL 8101

4. PE30BTA7DP | PE30BTP7DP
Rivestimento | Upholstery | Revêtement | Revestimiento - JET.FIDIVI 9110 - POLO.EFFETIGEST 0845

E50



E50

E50 è una seduta dal carattere deciso e importante. Un design forte che connota l'ambiente di lavoro.



E50 is a chair with a strong character and a distinctive design, which plays a leading role in the environment in which it is placed.

E50 est une chaise avec un caractère décisif et important. Un design fort qui donne une importance à l'environnement de travail.

E50 es un asiento con un carácter decidido e importante. Se presenta con un diseño fuerte, que caracteriza el entorno de trabajo.

2.

La forma particolare della seduta rende questa poltrona direzionale un must di accoglienza.

The unusual shape of the seat makes this executive chair an inviting must-have.

La forme particulière de la chaise rend ce fauteuil de direction un must de l'accueil.

La forma particular del asiento hace que este sillón gerencial sea imprescindible en cada recepción.





3.



4.



Varianti | Variants | Variantes | Variantes

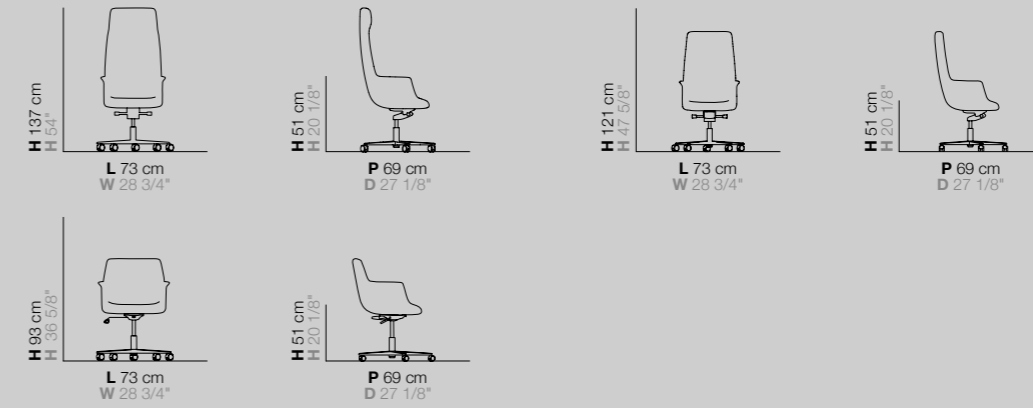

Finiture | Finishes | Finitions | Acabados

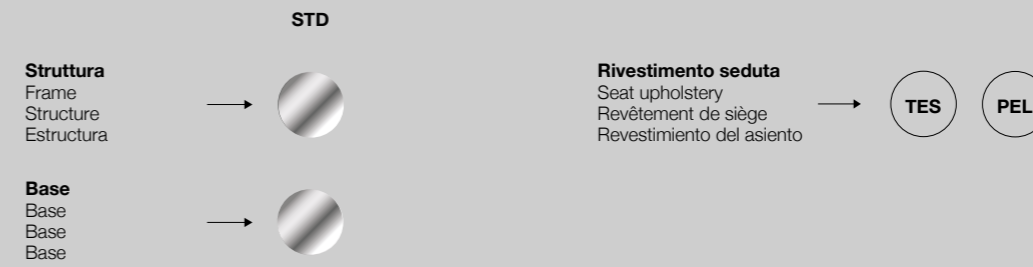

Mix & match



1. PE50ATP8DP | PE50DTP8DV
Rivestimento | Upholstery | Revêtement | Revestimiento - POLO.EFFETIGEST 0860

2. PE50ATP8DP
Rivestimento | Upholstery | Revêtement | Revestimiento - POLO.EFFETIGEST 0947

3. PE50ATC8DP | PE50DTC8DV | PE50BTD8DP
Rivestimento | Upholstery | Revêtement | Revestimiento - ACTON.VESCOM 7062.11 - ACTON.VESCOM 7062.32 - WOLIN.VESCOM 7050.26

4. PE50ATP8DP | PE50ATD8DP
Rivestimento | Upholstery | Revêtement | Revestimiento - POLO.EFFETIGEST 0860 - WOLIN.VESCOM 7050.17

visitor

Le sedute “visitor” o visitatore sono ideali per un utilizzo non prolungato, progetti contract, allestimento di sale d’attesa di studi professionali oppure per sale riunioni, conferenze aziendali o d’ufficio, oltre che per funzioni di servizio in ambiti domestici.

Si tratta di sedie che si caratterizzano per la massima versatilità, pensate per garantire il miglior equilibrio possibile fra necessità di comfort, praticità e distintiva eleganza.

“Visitor” chairs are designed for short-term use, ideal for contract projects, for furnishing waiting rooms in professional and medical environments, for business or office meetings and conferences, and for service functions in domestic environments.

These chairs are characterised by maximum versatility in order to guarantee the best possible balance between the need for comfort and prestige. They are of remarkable practicality and at the same time of unmistakable elegance.

Les assises “visitor” ou visiteurs sont parfaites pour une utilisation pas prolongée, idéales pour projets contract, la mise en place pour les salles d’attente de bureaux professionnels, réunions, conférences, ainsi que pour fonctions de service domestique.

Il s’agit de chaises très polyvalentes, pensées pour assurer le meilleur équilibre entre nécessité de confort, grande praticité et d’une élégance distinctive.

Las sillas “visitor” o de visita son adecuadas para un uso no prolongado, ideales para proyectos contract, la decoración de salas de espera en despachos profesionales y médicos, reuniones y conferencias en empresas u oficinas, así como para funciones de servicio en entornos domésticos.

Estas sillas se caracterizan por su máxima versatilidad, diseñadas para garantizar el mejor equilibrio posible entre comodidad, practicidad y una elegancia distintiva.

88
V20

V20



V20 è una seduta versatile, che si adatta a diverse tipologie di ambiente. Presenta linee eleganti e semplici che le danno un tocco moderno.

V20 is a versatile chair that adapts to different types of environments. It has elegant and simple lines that give it a modern touch.

V20 est une chaise polyvalente, qui s'adapte aux différents types d'environnement. Elle est équipée de lignes élégantes et simples que lui donnent une touche moderne.

V20 es un asiento inteligente, que se adapta a diferentes tipos de entorno. Presenta unas líneas elegantes y sencillas que le confieren un toque moderno.



La struttura è disponibile nelle varianti bianco e nero e la seduta può essere rivestita con la vasta gamma di tessuti disponibili.



The frame is available in white or black and the seat can be upholstered in a wide range of fabrics.

La structure est disponible en blanc et en noir et l'assise peut être revêtue en toutes finitions disponibles.

La estructura está disponible en blanco y negro, colores acompañados por una amplia gama de tejidos ecosostenibles.



1. PV20DRS6UU

Rivestimento | Upholstery | Revêtement | Revestimiento - STANDARD 8033

2. PV20DRA6MZ

Rivestimento | Upholstery | Revêtement | Revestimiento - JET.FIDIVI 9804

3. PV20DRS6MZ | PV20DRA6QU | PV20DRA6UU | PV20DRA6AS

Rivestimento | Upholstery | Revêtement | Revestimiento - STANDARD 8033 - JET.FIDIVI 9703 - JET.FIDIVI 9305 - CURA.GABRIEL 61168

4. PV20DRS6UU | PV20DRA6UU

Rivestimento | Upholstery | Revêtement | Revestimiento - STANDARD 8033 - CURA.GABRIEL 68182



Varianti | Variants | Variantes | Variantes

V20

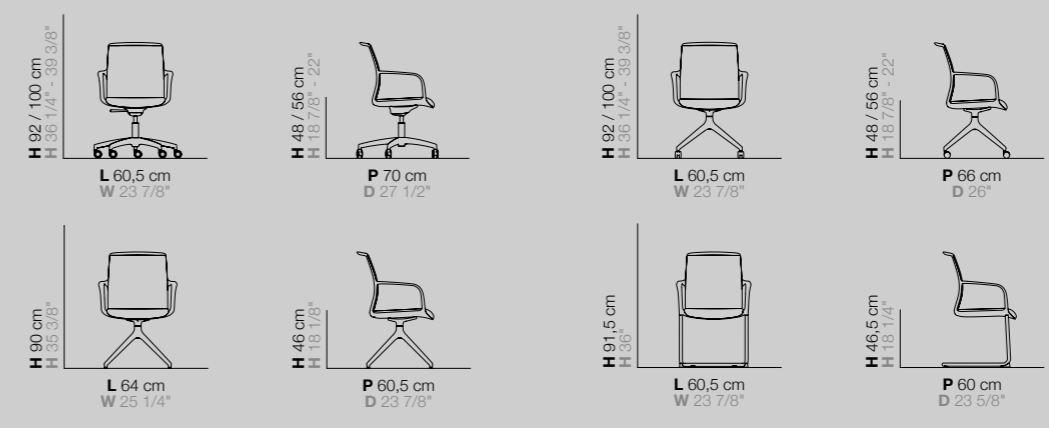

Finiture | Finishes | Finitions | Acabados

Struttura
Frame
Structure
Estructura

→ **STD**

→

Base
Base
Base
Base

→

Rivestimento sedile
Seat upholstery
Revêtement de siège
Revestimiento del asiento

→

Rivestimento schienale
Backrest upholstery
Revêtement du dossier
Revestimiento del respaldo

→

Mix & match

Varianti Variants Variantes Variantes	Schienali Backrests Dossier Respaldos	Meccanismi Mechanisms Mécanismes Mecanismos	Colori struttura Frame colours Couleurs structure Colores estructura	Colori base Base colours Couleurs base Colores base	Rivestimento seduta Seat upholstery Revêtement de siège Revestimiento del asiento

hybrid

La categoria “hybrid” o ibrida vuole soddisfare particolari esigenze che non trovano piena risposta dalle altre linee più specifiche.

Le sedute sono versatili e si adattano facilmente a diverse tipologie di ambienti.

Sono prodotti dalle linee più semplici, che non presentano particolari rivestimenti e finiture. Conseguentemente, sono ideali ad accompagnare tavoli hot-desking o riunione.

The ‘Hybrid’ category is designed to meet specific needs that are not fully met by other, more specific lines.

The chairs are versatile and easily adaptable to different types of environments.

These chairs have clean and essential lines and do not have special upholstery and finishes. This makes them ideal for hot-desking or meeting tables.

La catégorie “hybride” ou hybride est destinée à répondre à des besoins particuliers qui ne sont pas entièrement satisfaits par les autres lignes plus spécifiques.

Les chaises sont polyvalentes et s’adaptent facilement à différents types d’environnements.

Il s’agit de produits aux lignes plus simples, sans rembourrage ni finitions particulières. Par conséquent, elles sont idéales pour accompagner les tables de hot-desking ou de réunion.

La categoría “híbrida” o híbrida está pensada para satisfacer necesidades particulares que no quedan totalmente cubiertas por las otras líneas más específicas. Son asientos versátiles que se adaptan fácilmente a distintos tipos de entornos.

Son productos de líneas más sencillas que no presentan tapizados ni acabados especiales.

En consecuencia, son ideales para acompañar mesas de hot-desking o de reuniones.

98
H10

H10



H10 è una collezione di sedute ibride dal design tecnico ed essenziale. La sua versatilità la rende perfettamente collocabile in diversi ambiti e contesti.

H10 is a collection of hybrid chairs with an essential and technical design. Its versatility makes it perfectly adaptable to different spaces and contexts.

H10 est une collection de chaises hybrides avec un design technique et essentiel. Elle trouve une parfaite collocation dans nombreux domaines et espaces.

H10 es una colección de asientos híbridos con un diseño técnico y esencial. Su versatilidad la hace perfectamente ubicable en múltiples ámbitos y espacios.





2.

La seduta è interamente in rete e nel basamento dello sgabello è presente un poggiapiedi ad anello in acciaio.



3.

The seat is made entirely of mesh and the stool base is fitted with an aluminium ring footrest.

La chaise est entièrement en résille et la structure du tabouret est équipée d'un repose-pieds en anneau d'acier.

El asiento es totalmente de malla y en la base del taburete hay un reposapiés de aro de acero.



4.

Varianti | Variants | Variantes | Variantes

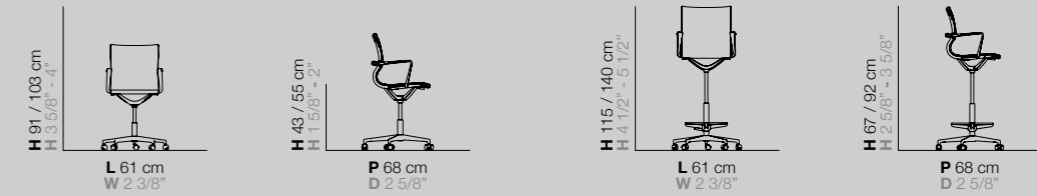

Finiture | Finishes | Finitions | Acabados

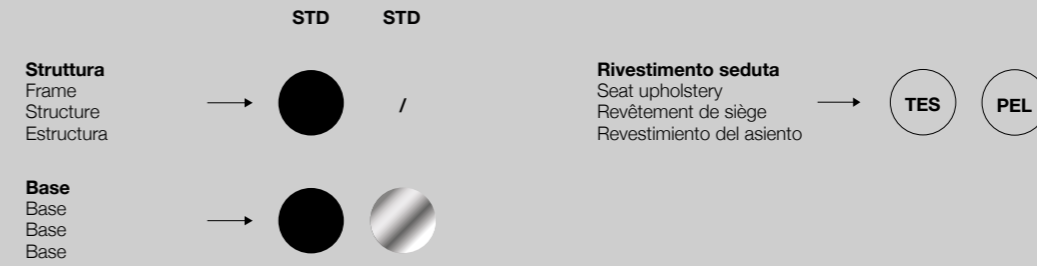

Mix & match

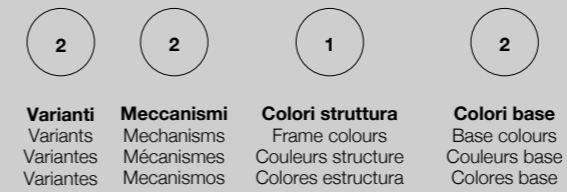

- 1. PH10DRS6AX | PH10DRS6YX**
Rivestimento | Upholstery | Revêtement | Revestimiento - NK00
- 2. PH10DRS6AX**
Rivestimento | Upholstery | Revêtement | Revestimiento - NK00
- 3. PH10DRS6YX**
Rivestimento | Upholstery | Revêtement | Revestimiento - NK00
- 4. PH10DRS6AX - PH10DRS6YX**
Rivestimento | Upholstery | Revêtement | Revestimiento - NK00

community

Le sedute “community” o per la collettività soddisfano le esigenze di platee numerose o luoghi con cambio frequente di fruitori (locali pubblici, sia al chiuso che all’aperto).

Sono estremamente leggere e maneggevoli, per favorirne gli spostamenti durante gli allestimenti. La loro impilabilità conferisce un valore aggiunto, che ne facilita lo stoccaggio.

“Community” chairs are great for accommodating large groups of people and for places with a high turnover rate. They can be found indoors and outdoors and are ideal for public spaces.

They are incredibly lightweight and manoeuvrable, making them easy to move around when setting up. Their stackability adds value by making them easier to store.

Les assises “Community” ou pour la communauté sont idéales pour accueillir de grands groupes de personnes ou pour les lieux où le taux de rotation est élevé. On les trouve à l’intérieur et à l’extérieur et elles sont idéales pour les espaces publics.

Elles sont incroyablement légères et maniables, ce qui permet de les déplacer facilement lors de l’installation. Leur empilabilité confère une valeur ajoutée en facilitant leur stockage.

Las sillas “Community” o para colectividades son ideales para acomodar a grandes grupos de personas y para lugares con un alto índice de rotación. Se pueden encontrar en interiores y exteriores y son ideales para espacios públicos.

Son increíblemente ligeras y maniobrables, lo que facilita su desplazamiento durante el montaje. Además, son apilables, lo que facilita su almacenamiento.

106
C10

112
C20

C10



C10 è una sedia dalle linee minimal ed essenziali, perfetta per gli ambienti outdoor.

C10 is a community chair with minimal and essential lines, perfect for outdoor environments.

C10 est une chaise communautaire aux lignes minimales et essentielles, parfaite pour les environnements extérieurs.

C10 es una silla comunitaria de líneas minimalistas y esenciales, perfecta para entornos exteriores.

La sua struttura a monoblocco in polipropilene garantisce notevole durabilità nel tempo e resistenza agli agenti atmosferici.

C10



Its one-piece polypropylene frame guarantees remarkable durability and weather resistance.

Sa structure en monobloc de polypropylène garantit une considérable durabilité dans le temps et résistance aux agents atmosphériques.

Su estructura en monobloque de polipropileno garantiza una notable durabilidad en el tiempo y resistencia a los agentes atmosféricos.



Tra le declinazioni possibili per C10 troviamo @Rinasco, la versione totalmente riciclata.

Possible declinations for C10 include @Rinasco, the fully recycled version.

Parmi les déclinaisons possibles pour C10 on trouve @Rinasco, la version totalement recyclée.

Entre las posibles declinaciones para C10 encontramos @Rinasco, la versión totalmente reciclada.



Impilabilità
Stackability
Empilabilité
Apilabilidad

POL
MAX 5 PZ
PCS PCS PIEZAS



Impilabilità
Stackability
Empilabilité
Apilabilidad

POL
MAX 5 PZ
PCS PCS PIEZAS



3.

1. **PC10013PPO | PC10011PPO**
Snow

2. **PC10011PPO**
Cream

3. **PC10011PPO | PC10014PPO | PC10013PPO | PC10015PPO**
Sky - Charcoal - Green tea - Snow

Varianti | Variants | Variantes | Variantes

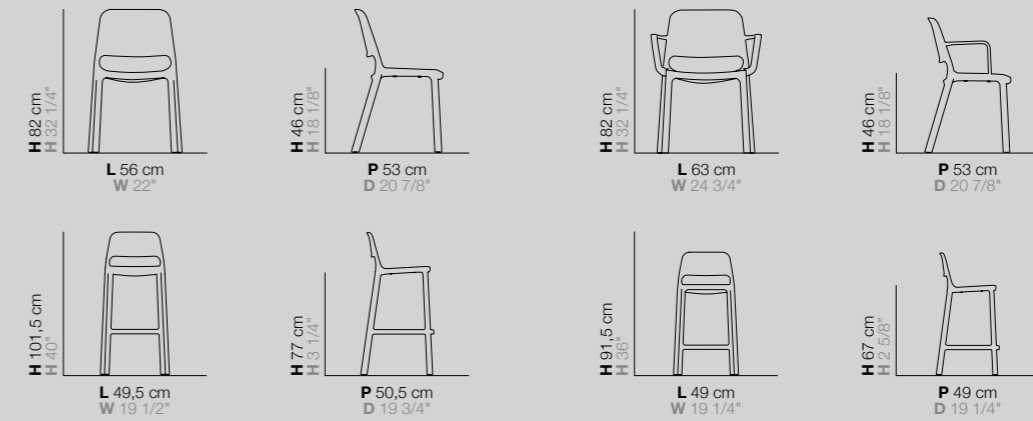

Finiture | Finishes | Finitions | Acabados

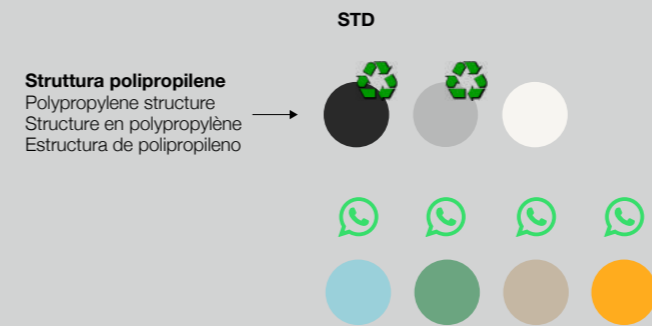

100% riciclato - Rinasco®
100% recycled - Rinasco®
100% recyclé - Rinasco®
100% reciclado - Rinasco®

Mix & match



Varianti
Variants
Variantes
Variantes

Colori struttura
Frame colours
Couleurs structure
Colores estructura

C20

C20 è la soluzione perfetta per ogni tipo di platea. La collezione si declina in otto differenti tipologie di sedute per rispondere a tutte le esigenze del cliente.



C20 is the perfect solution for every type of audience. The collection is available in eight different types of seating to meet all customer requirements.

C20 est une solution parfaite pour tout type de public. La collection se décline en huit différents types de chaises pour répondre à tous besoins des clients.

C20 es la solución perfecta para todo tipo de público. La colección está disponible en ocho tipos de asientos para satisfacer todas las necesidades de los clientes.

2.

La scocca è
disponibile anche
nella versione
con rivestimento
anteriore, che ne
esalta la versatilità di
utilizzo ed il comfort.



114

C20

The chair is also available
with front upholstery
for added versatility
and comfort.

La coque est également
disponible dans une version
recouverte sur le devant, ce
qui améliore sa polyvalence
d'utilisation et son confort.

La carcasa también está
disponible en una versión
cubierta por delante, lo que
aumenta su versatilidad de
uso y comodidad.



115



Impilabilità
Stackability
Empilabilité
Apilabilidad

POL
MAX 15 PZ
PCS PCS PIEZAS



Impilabilità
Stackability
Empilabilité
Apilabilidad

POL
MAX 20 PZ
PCS PCS PIEZAS

TES
MAX 15 PZ
PCS PCS PIEZAS



Impilabilità
Stackability
Empilabilité
Apilabilidad

TES
MAX 10 PZ
PCS PCS PIEZAS



Impilabilità
Stackability
Empilabilité
Apilabilidad

POL
MAX 15 PZ
PCS PCS PIEZAS

TES
MAX 10 PZ
PCS PCS PIEZAS



Impilabilità
Stackability
Empilabilité
Apilabilidad

POL
MAX 20 PZ
PCS PCS PIEZAS

TES
MAX 15 PZ
PCS PCS PIEZAS



Impilabilità
Stackability
Empilabilité
Apilabilidad

POL
MAX 15 PZ
PCS PCS PIEZAS

TES
MAX 10 PZ
PCS PCS PIEZAS



3.

1. PC20101PPO
Ash - Graphite - Hazelnut

2. PC20122PPO
Hazelnut

3. PC20111PPO | PC20122PPO | PC20101PPO | PC20122RIA | PC20112RIA | PC20131RIA | PC20102PPO | PC20132RIA
Grephite - Hazelnut - Graphite - Graphite | STANDARD 8033 - Ash | JET.FIDIVI 9804 - Hazelnut | JET.FIDIVI 9110 - Ice white - Grephite | SATANDARD 8033

2. PC20122RIA | PC20121PPO
Hazelnut | JET.FIDIVI 9110 - Grephite



C20

Varianti | Variants | Variantes | Variantes

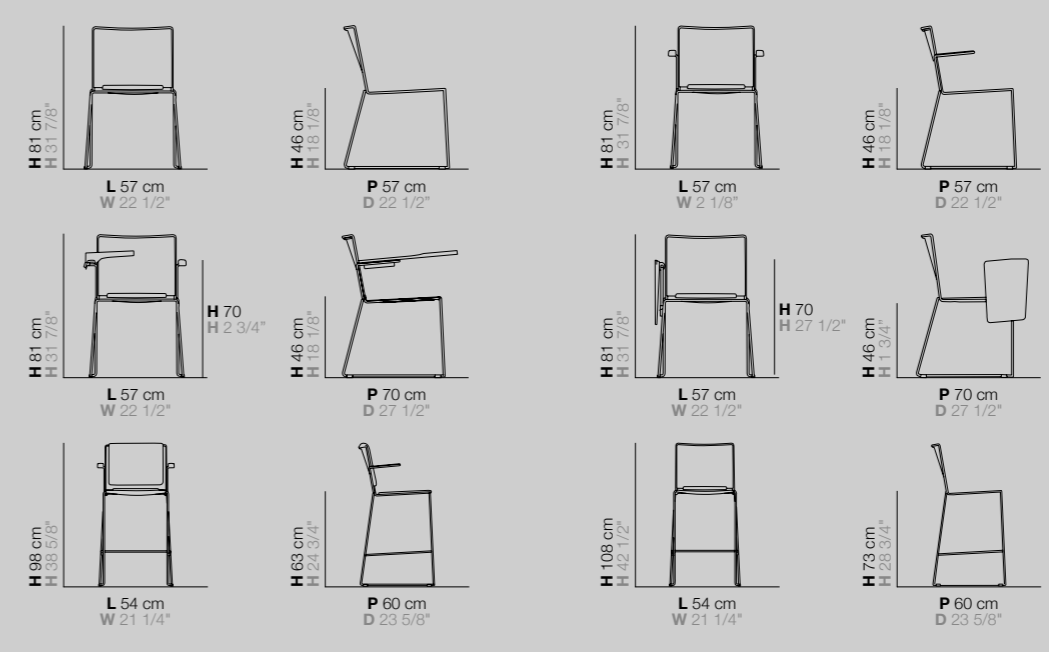

Carrello | Trolley | Chariot | Carrito

Carrello | Trolley | Chariot | Carrito

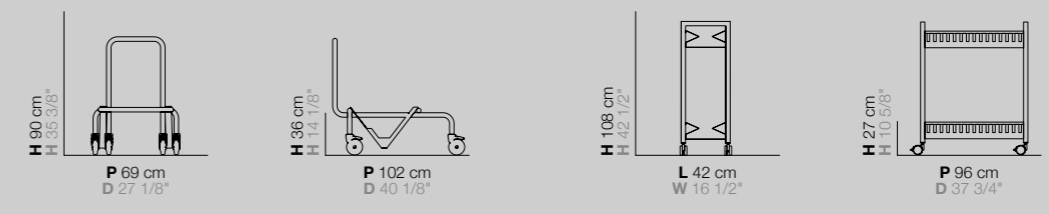

Finiture | Finishes | Finitions | Acabados

	STD	STD	STD				
Scocca Shell Coque Concha			/				
Struttura senza scrittoio Frame without writing table Structure sans tablette écritoire Estructura sin escritorio							
Struttura con scrittoio Frame with writing table Structure avec tablette écritoire Estructura con escritorio	/	/					
						Rivestimento sedile Seat upholstery Revêtement de siège Revestimiento del asiento	
						Rivestimento schienale Backrest upholstery Revêtement du dossier Revestimiento del respaldo	
						Il rivestimento è obbligatorio sia sul sedile che nello schienale Upholstery is mandatory in both seat and back Le rembourrage est obligatoire pour le siège et le dossier El revestimiento es obligatorio tanto en el asiento como en el respaldo.	

Mix & match

Varianti Variants Variantes Variantes	Scocca Shell Coque Concha	Colori struttura senza tavoletta Frame colours without writing table Couleurs structure sans tablette écritoire Colores estructura sin escritorio	Struttura con tavoletta Frame colours with writing table Couleurs structure avec tablette écritoire Colores estructura con escritorio	Tessuti Fabrics Tissus Tejidos

sofà

I “sofà” o divani vogliono fornire un’opzione di arredo per spazi di relax e attesa, uffici e zone lounge.

Sofas are designed to provide comfort and restfulness in waiting areas, offices, and lounge areas.

Les canapés sont conçus pour offrir une option de mobilier pour les espaces de détente et d’attente, les bureaux et les zones de salon.

Los sofás están diseñados para ofrecer una opción de mobiliario para espacios de relax y espera, oficinas y zonas de lounge.

122
S50

S50



La collezione S50 fornisce molteplici opzioni di seduta. La poltrona e i sofa da 2 oppure 3 posti ben si inseriscono in tutti gli spazi accoglienza e attesa da arredare.

The S50 collection offers multiple seating solutions. The armchair and the 2 or 3-seater sofas fit well into all reception and waiting areas to be furnished.

La collection S50 offre de multiples options d'assise. Le fauteuil et les canapés 2 ou 3 places s'intègrent parfaitement dans tous les espaces d'accueil et d'attente à meubler.

La colección S50 ofrece múltiples opciones de asientos. El sillón y los sofás de 2 o 3 plazas se adaptan bien a todos los espacios de recepción y espera para amueblar.

1.

S50

Linee semplici e definite donano eleganza alla poltrona e ai sofà, protagonisti in spazi comuni in cui le parole d'ordine sono relax e stile.

2.



The simple, defined and elegant lines make the armchairs and sofas the protagonists of common spaces where relaxation and style are the keywords.

Des lignes simples et définies donnent de l'élégance au fauteuil et aux canapés, protagonistes d'espaces communs où détente et style sont les maîtres mots.

Líneas simples y definidas aportan elegancia al sillón y a los sofás, que son protagonistas de los espacios comunes donde las palabras clave son relajación y estilo.





Il livello di personalizzazione è un tratto distintivo di S50. Si contano 104 finiture tessuto combinabili con 7 colori epossidici dei piedini. Una versatilità e creatività che permettono infinite soluzioni.

The level of customisation is a hallmark of S50: 104 fabric finishes can be combined with 7 epoxy colours for the legs. This versatility and creativity allow for infinite solutions.

Le niveau de personnalisation est un trait distinctif de la collection S50. Il y a 104 finitions de tissu combinables avec 7 couleurs époxy pour les pieds. Une polyvalence et une créativité qui permettent des solutions infinies.

El nivel de personalización es una característica distintiva del S50. Hay 104 acabados de tela combinables con 7 colores epoxi para las patas. Versatilidad y creatividad permiten soluciones infinitas.

Varianti | Variants | Variantes | Variantes

S50

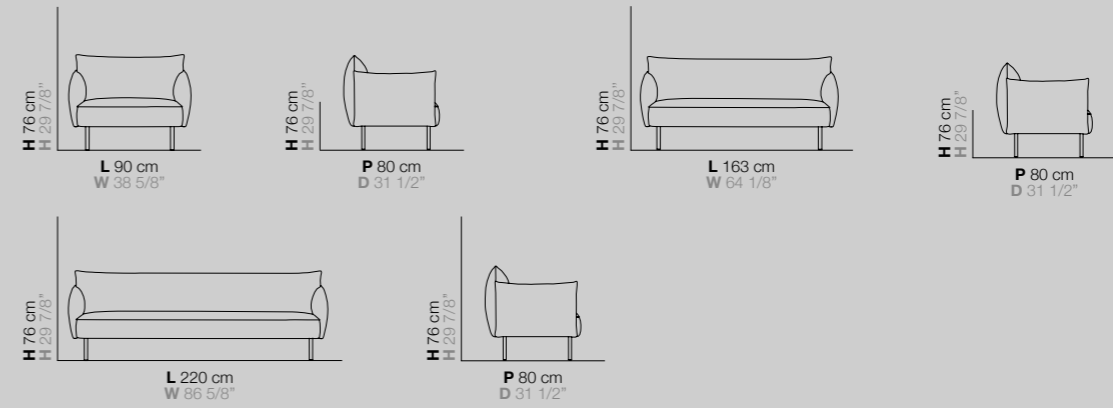
Finiture | Finishes | Finitions | Acabados

Mix & match

1. ZPS50006RIT
Rivestimento | Upholstery | Revêtement | Revestimiento - ONE.FIDIVI 6555 | NB

2. ZPS50001RIT
Rivestimento | Upholstery | Revêtement | Revestimiento - POLO.EFFETIGEST 0947 | SR

3. ZPS50001RIT | ZPS50007RIT | ZPS50006RIT
Rivestimento | Upholstery | Revêtement | Revestimiento
CRISP.GABRIEL 4721 | JET.FIDIVI 9804 | WR - PASSION.GABRIEL 16101 | PASSION.GABRIEL 8101 | SR - POLO.EFFETIGEST 0860 | BL

4. ZPS50001RIT
Rivestimento | Upholstery | Revêtement | Revestimiento - JET.FIDIVI 9703 | SR - POLO.EFFETIGEST 0947 | SR

materials and finishes



RET

RETE MEGA

Mega mesh | Résille Mega | Malla Mega

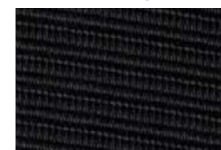

001

Mod. T10, T30, T35, T50, M10

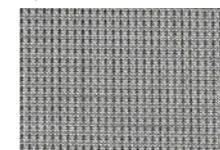

003

Mod. T10, T30, T35, T50, M10

RETE PORTANTE

Supporting mesh | Résille de soutien | Malla reforzada

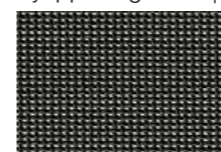

N00 - Mod. E10

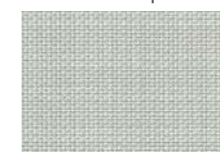

N09 - Mod. E10



BL - Mod. T70, V20



NK00 - Mod. H10

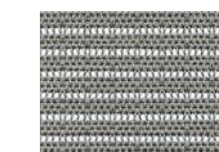

NK09 - Mod. H10

TES

BRAVO - Fidivi (CAT. S)

Tessuto | Fabric | Tissu | Tejido



8033



8009

Legenda simboli

Symbols key | Légende symboles | Leyenda signos

STD

Standard
Standard
Standard
Estandard



Su richiesta
On request
Sur demande
A petición



Impilabilità
Stackability
Empilabilité
Apilabilidad



Impilabilità su carrello porta sedie
Stackability on chair trolley
Empilabilité sur chariot porte-chaises
Apilabilidad en carrito de sillas



100% riciclato
100% recycled
100% recyclé
100% reciclado

POL

Polipropilene
Polypropylene
Polypropylène
Polipropileno

RET

Rete
Mesh
Résille
Malla

TES

Tessuto
Fabric
Tissu
Tejido

PEL

Pelle
Leather
Cuir
Cuero

EPX

Epossidico
Epoxy
Époxy
Epoxi

SECRET - Flukso (CAT. A)

Similpelle | Faux leather | Faux-cuir | Semipiel



1003 1024 1006 1026 1019



1033 1012 1014 1017

ONE - Fidivi (CAT. A)

Tessuto | Fabric | Tissu | Tejido

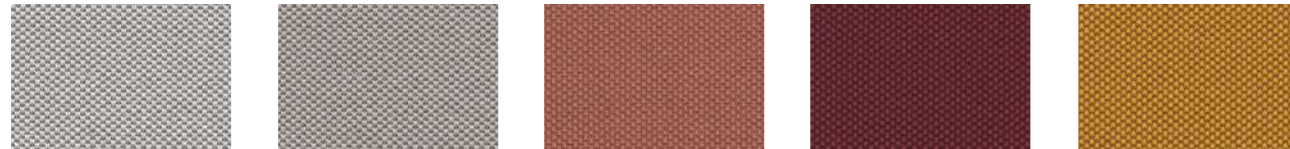

8504 1506 4037 4503 3530



7521 7526 6555 8033

CURA - Gabriel (CAT. A)

Tessuto | Fabric | Tissu | Tejido



61168 60110 61258 61233 62083

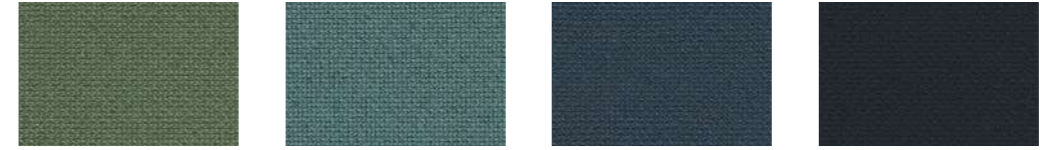

68182 66167 66170 60111

JET - Fidivi (CAT. A)

Tessuto | Fabric | Tissu | Tejido

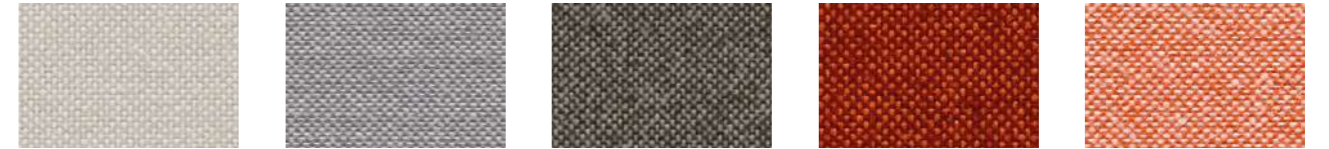

9110 9804 9108 9402 9301



9305 9703 9702 7014 9608

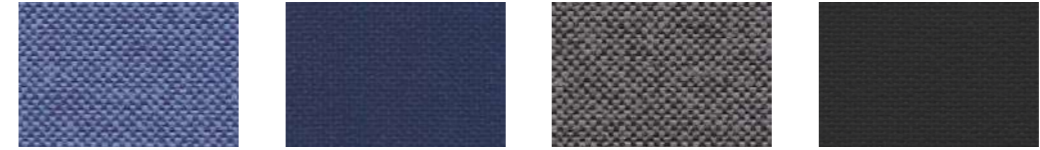

9601 6098 9294 8033

GO UNI - Gabriel (CAT. B)

Tessuto | Fabric | Tissu | Tejido

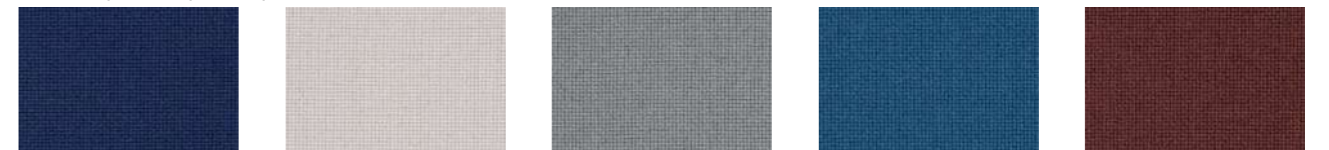

66138 60093 60083 66139 61145



61144 67071 68149 60999

GO CHECK - Gabriel (CAT. B)

Tessuto | Fabric | Tissu | Tejido



60093 60083 60084 61145 61141

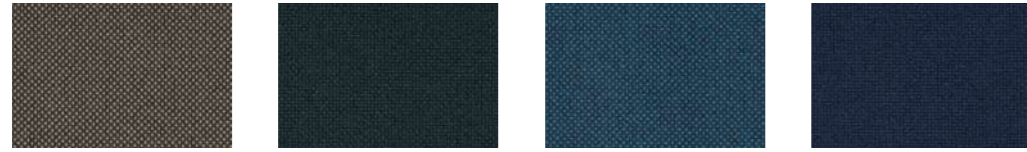

61139 68149 66139 66138

ACTON - Vescom (CAT. C)

Tessuto | Fabric | Tissu | Tejido



7062.20 7062.06 7062.05 7062.11 7062.29

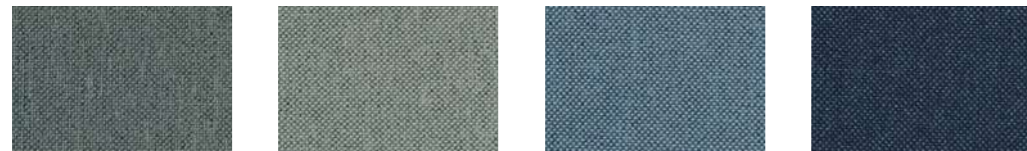

7062.31 7062.32 7062.19 7062.18

PASSION - Gabriel (CAT. C)

Tessuto | Fabric | Tissu | Tejido

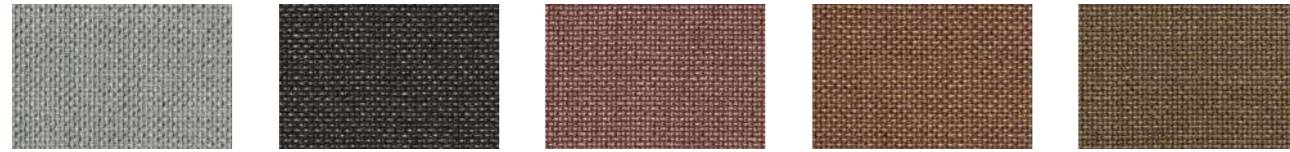

13101 1101 4101 16101 2101

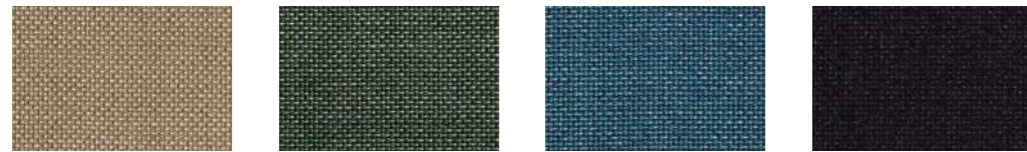

8101 24101 20101 12101

WOLIN - Vescom (CAT. D)

Tessuto | Fabric | Tissu | Tejido

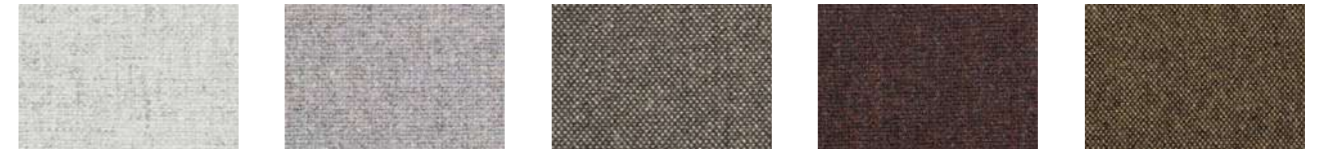

7050.17 7050.03 7050.26 7050.47 7050.19



7050.37 7050.42 7050.09 7050.10

CRISP - Gabriel (CAT. D)

Tessuto | Fabric | Tissu | Tejido



4032 4033 4021 4603 4731

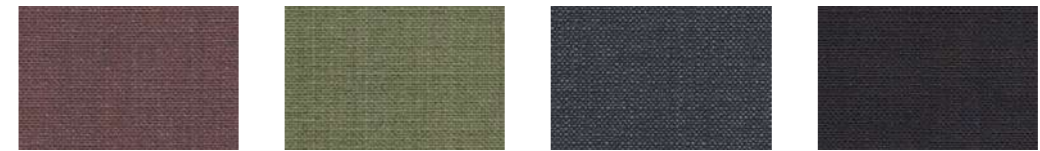

4721 4752 4013 4125

PEL

POLO - Anica (CAT. P)

Pelle | Leather | Cuir | Cuero

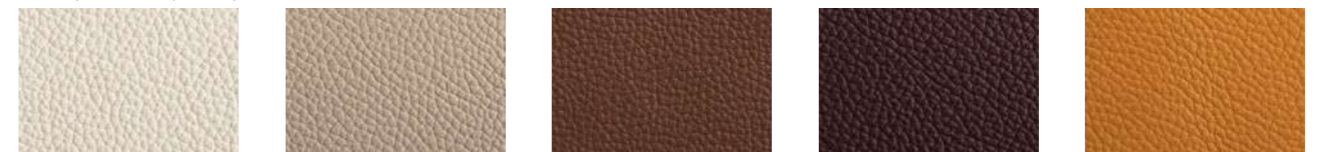

0947 0826 0822 0845 0838

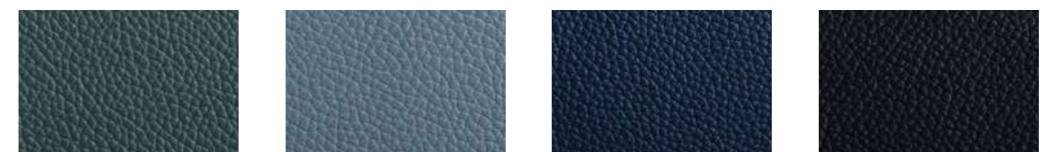

0832 0878 0856 0860

PPO
POLIPROPILENE

Polypropylene | Polypropylène | Polipropileno

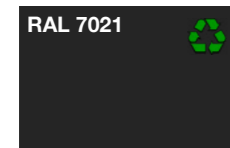

Carbone - Mod. C10
Charcoal
Charbon
Carbón



Roccia - Mod. C10
Rock
Roche
Roca

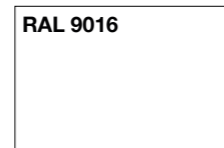

Neve - Mod. C10
Snow
Neige
Nieve

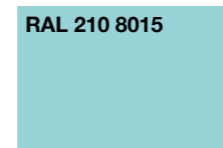

Cielo - Mod. C10
Sky
Ciel
Cielo

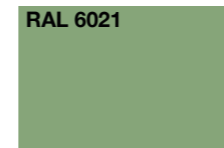

Tè verde - Mod. C10
Green tea
Thé vert
Tè verde

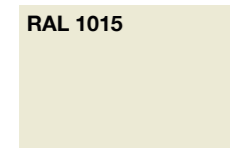

Crema - Mod. C10
Cream
Crème
Crema

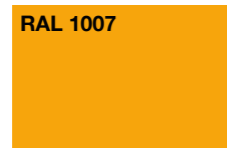

Zucca - Mod. C10
Pumpkin
Citrouille
Calabaza

PPO
POLIPROPILENE

Polypropylene | Polypropylène | Polipropileno



Grafite - Mod. C20
Graphite
Graphite
Grafito

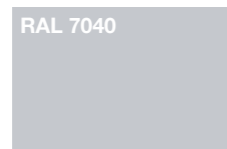

Cenere - Mod. C20
Ash
Cendre
Ceniza

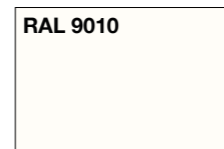

Ghiaccio - Mod. C20
Ice white
Glace
Hielo

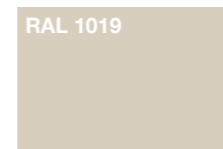

Nocciola - Mod. C20
Hazelnut
Noisette
Avellana

EPX
EPOSSIDICO Mod. E10, S50

Epoxy | Époxy | Epoxi



Bianco
White
Blanc
Blanco



Rosa sabbia
Sand rose
Rose sable
Rosa arena



Rosso vino
Wine red
Bordeaux
Vino tinto



Blu notte
Night blue
Bleu nuit
Azul medianoche



Antracite
Anthracite
Antracite
Antracita



Verde intenso
Deep green
Vert foncé
Verde intenso



Nero
Black
Noir
Negro

Visual & graphic design
Alea marketing + communication

AL/CACE/CD

Le finiture contenute nella stampa sono puramente indicative e non sono di riferimento per le forniture del prodotto
Due to the printing process, finishes shown in this document are for illustration only. The finish on the final item may differ slightly from the printed illustration
Les finitions contenues dans l'impression sont purement indicatives et ne sont pas pertinentes pour les fournitures du produit
Los acabados contenidos en la impresión son puramente indicativos y no son de referencia para los suministros del producto

alea
aleaoffice.com



ALEA HQ AND SHOWROOM: Via Col de Rust, 19 - 33070 Sarone di Caneva (PN), Italia - tel +39 0434 777333
www.aleaoffice.com - email info@aleaoffice.com **MILAN SHOWROOM:** Via Cino del Duca, 2 - 20122 Milano, Italia - email info@aleaoffice.com **PARIS SHOWROOM:** 176 Avenue Charles de Gaulle - 92200 Neuilly-sur-Seine, France - email france@aleaoffice.com
LONDON SHOWROOM: 50-54 Clerkenwell Road - London, EC1M 5PS - email ukoffice@aleaoffice.com
NEW YORK SHOWROOM: 25W, 31st Street, #9 - New York, NY 10001, USA - tel +1 305 4701200 - email info@alea-usa.com
MIAMI SHOWROOM: Midtown 2, 3449 NE 1st Avenue L-32 - Miami, FL 33137, USA - tel +1 305 4701200 - email info@alea-usa.com