

alea

meeting-  
tables

meeting tables

# sale riunioni

Meeting tables  
Salles de réunion  
Salas de juntas

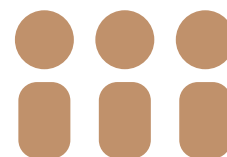

06  
Archimede

40  
Oasi

10  
Itube

44  
Odeon

14  
Atreo wood

48  
Ortho

18  
Atreo

52  
Rendez-Vous

22  
Blade

56  
Titano

26  
Blade X

58  
Zefiro

30  
Eracle

62  
Zefiro X

32  
Ibis

64  
Atlante

36  
Italo\_forty

68  
Tavoli



17.

6.

3.

5.

4.

11.

2.

13.

16.

14.

15.

9.

12.

1.

7.

8.

10.



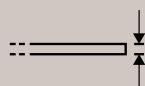

**forme piano**  
top shapes  
formes de plateau  
formas de sobre

**con profilo**  
with profile  
avec profil  
con perfil

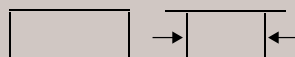

**cablaggio nascosto**  
hidden wiring  
câblage caché  
cableado oculto

**ambiente**  
environment  
ambiance  
ambiente

		<b>forme piano</b> top shapes formes de plateau formas de sobre	<b>con profilo</b> with profile avec profil con perfil		<b>cablaggio nascosto</b> hidden wiring câblage caché cableado oculto	<b>ambiente</b> environment ambiance ambiente
1.	Archimede	40 mm	X	X	X	managerial   classic
x.	Itube	30 mm			X	modern
2.	Atreo wood	30 mm		X	X	modern
3.	Atreo	30 mm		X	X	modern
4.	Blade	30 mm			X	modern
5.	Blade X	30 mm			X	managerial   classic
6.	Eracle	80 mm	X	X	X	classic
7.	Ibis	30 mm			X	modern
8.	Italo_forty	8   18 mm		X		modern
9.	Oasi	40 mm	X		X	classic
10.	Odeon	40 mm	X	X	X	classic
11.	Ortho	18   30 mm		X	X	modern
12.	Rendez-Vous	18 mm			X	modern
13.	Titano	60 mm	X	X	X	classic
14.	Zefiro	12 mm		X	X	modern   managerial
15.	Zefiro X	10   12 mm		X	X	managerial
16.	Atlante	30 mm			X	modern
17.	Tavoli con basamento	18   30   40   60 mm	X		X	modern   managerial

# Archimede



“ I tavoli Archimede sono una soluzione elegante per arredare le sale riunioni. Le geometrie delle gambe possono essere diverse: gamba ad anello, gamba ad L oppure gamba a T, anche mescolate tra loro in base al modello. I piani possono essere incorniciati da un profilo in alluminio. ”

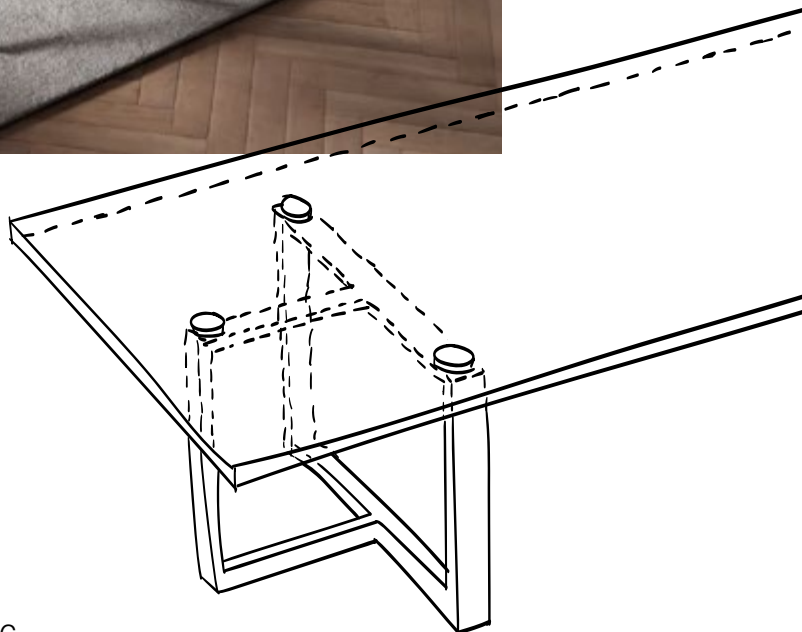



Archimede tables are an elegant solution to furnish meeting rooms. Leg geometries can be different: ring leg, L leg or T leg, also mixed together according to the model. Tops can be framed by an aluminium profile.

Les tables Archimede sont une solution élégante pour meubler les salles de réunion. Les géométries des pieds peuvent être différentes: pied en anneau, pied façonné en L ou pied façonné en T, également mélangés entre eux selon le modèle. Les plateaux peuvent être encadrés par un chant en aluminium.



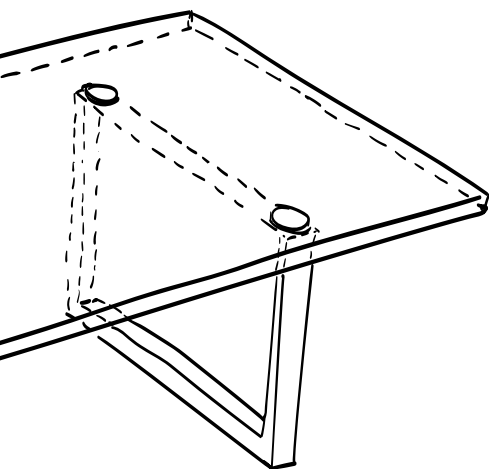

Las mesas de Archimede son una solución elegante para amueblar las salas de reuniones. Las geometrías de las patas pueden ser diferentes: pata de anillo, pata en L o pata en T, incluso mezcladas según el modelo. Los sobres pueden ser enmarcados por un perfil de aluminio.



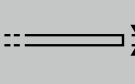

**geometric**  
**sleek**  
**architectural**

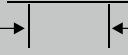

		<b>forme piano</b> top shapes formes de plateau formas de sobre	<b>con profilo</b> with profile avec profil con perfil			<b>cablaggio nascosto</b> hidden wiring câblage caché cableado oculto	<b>ambiente</b> environment ambiance ambiente
Archimede	40 mm		X	X	X	X	managerial   classic

**Gambe** | Legs | Pieds | Patas



**Gamba ad anello**  
Ring leg  
Pied en anneau  
Pata de anillo

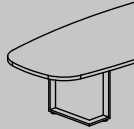

**gamba a L**  
L leg  
pied en L  
pata en L

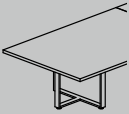

**Gamba a T**  
T leg  
Pied en T  
Pata en T

**Finiture** | Finishes | Finitions | Acabados

**Piano**  
Top  
Plateau  
Sobre



**Struttura**  
Structure  
Structure  
Estructura



**Tavoli riunione** | Meeting tables | Tables de réunion | Mesas de juntas



H 73,4 cm  
H 28 7/8"

Ø 100/120/130/150 cm  
Ø 39 3/8"-47 1/4"- 51 1/8"-59"

L/P 120/130/150 cm  
W/D 47 1/4"-51 1/8"-59"

L 210/280 - P 120 cm  
W 82 5/8"-110 1/4" - D 47 1/4"

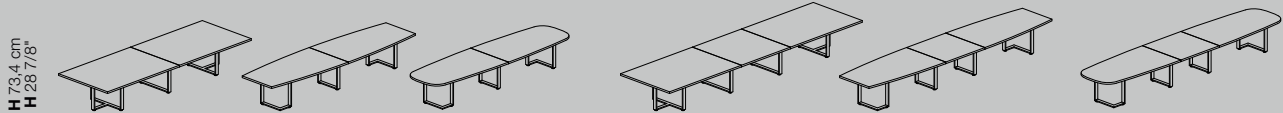

H 73,4 cm  
H 28 7/8"

L 440 - P 150 cm  
W 173 1/4" - D 59"

L 440 - P 120/150 cm  
W 173 1/4" -  
D 47 1/4"-59"

L 590 - P 150 cm  
W 232 1/4" - D 59"

L 560 - P 120 cm / L590 - P 150 cm  
W 220 1/2" - D 47 1/4"/ W 232 1/4" - D 59"

L 560 - P 120 cm  
W 220 1/2" - D 47 1/4"

# Itube



“ Itube è una collezione operativa dove l'estetica diventa funzione. ”





Itube is a collection where aesthetics become function.



Itube est une collection où l'esthétique devient fonction.

Itube es una colección en la que la estética se convierte en función.

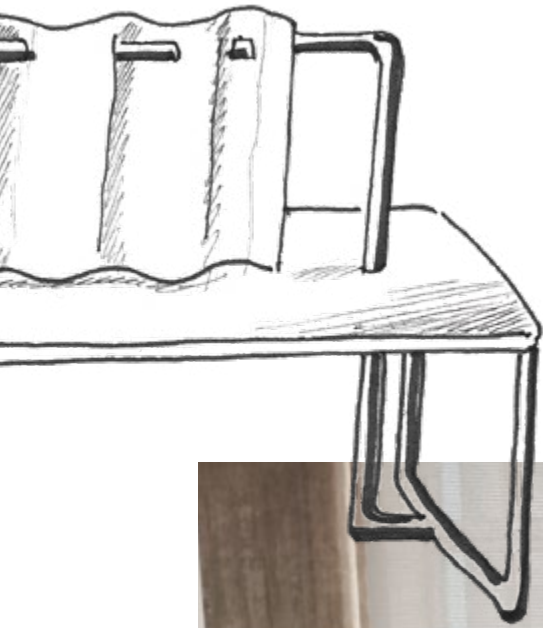
**modern**  
**innovative**  
**twisting**



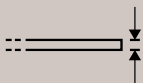

		<b>forme piano</b> top shapes formes de plateau formas de sobre	<b>con profilo</b> with profile avec profil con perfil		<b>cablaggio nascosto</b> hidden wiring câblage caché cableado oculto	<b>ambiente</b> environment ambiance ambiente	
Itube	30 mm				X	X	modern

**Piani** | Desk tops | Plateaux | Sobres

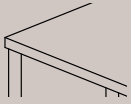

**Con angoli dritti**  
With straight corners  
Avec coins droits  
Con esquinas rectas

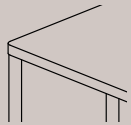

**Con angoli raggiati**  
With rounded corners  
Avec coins arrondis  
Con esquinas redondeadas

**Finiture** | Finishes | Finitions | Acabados

**Piano**  
Top  
Plateau  
Sobre



**Struttura**  
Structure  
Structure  
Estructura



**Tavoli riunione** | Meeting tables | Tables de réunion | Mesas de juntas

H 73,4  
H 29"



Ø 100/120/150 cm  
Ø 39 3/8"-47 1/4"-59"

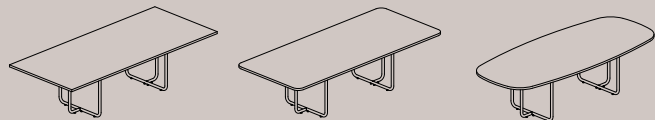

L 210/240/280 - P 120 cm  
W 82 5/8"-94 1/2"-110 1/4" - D 47 1/4"

# Atreo Wood





“ I tavoli riunione Atreo Wood si contraddistinguono grazie ad un look semplice e fresco. La gamba si caratterizza per l'inserito in legno massello che ne esalta l'aspetto organico. ”

Atreo Wood meeting tables are characterised by a simple and fresh look. The leg features a solid wood insert that enhances its organic feel.

Les tables de réunion Atreo Wood se caractérisent par leur aspect simple et frais. Le piètement est caractérisé par un insert en bois massif qui renforce l'aspect organique.

Las mesas de reuniones Atreo Wood destacan por un aspecto sencillo y fresco. La pata se caracteriza por un inserto de madera maciza que realza su aspecto orgánico.

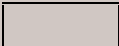

		<b>forme piano</b> top shapes formes de plateau formas de sobre	<b>con profilo</b> with profile avec profil con perfil			<b>cablaggio nascosto</b> hidden wiring câblage caché cableado oculto	<b>ambiente</b> environment ambiance ambiente
Atreo wood	30 mm			X	X		modern

**Piani** | Desk tops | Plateaux | Sobres



**Con angoli dritti**  
With straight corners  
Avec coins droits  
Con esquinas rectas



**Con angoli raggiati**  
With rounded corners  
Avec coins arrondis  
Con esquinas redondeadas

**Gambe** | Legs | Pieds | Patas

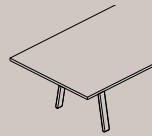

**A cavalletto**  
A-shape  
Tréteau  
Caballete

**Finiture** | Finishes | Finitions | Acabados

**Piano**  
Top  
Plateau  
Sobre



**Struttura**  
Structure  
Structure  
Estructura



**Tavoli riunione** | Meeting tables | Tables de réunion | Mesas de juntas

H 73,4 cm  
H 28 7/8"

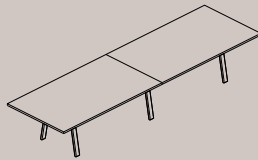
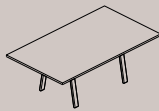

Ø 90/100/120/130/150 cm  
Ø 35 3/8"/39 3/8"/47 1/4"/  
51 1/8"/59"

L 210/280 - P 120 cm  
W 82 5/8"/110 1/4"  
D 47 1/4"

L 420/560 - P 120 cm  
W 165 3/8"/220 1/2"  
D 47 1/4"



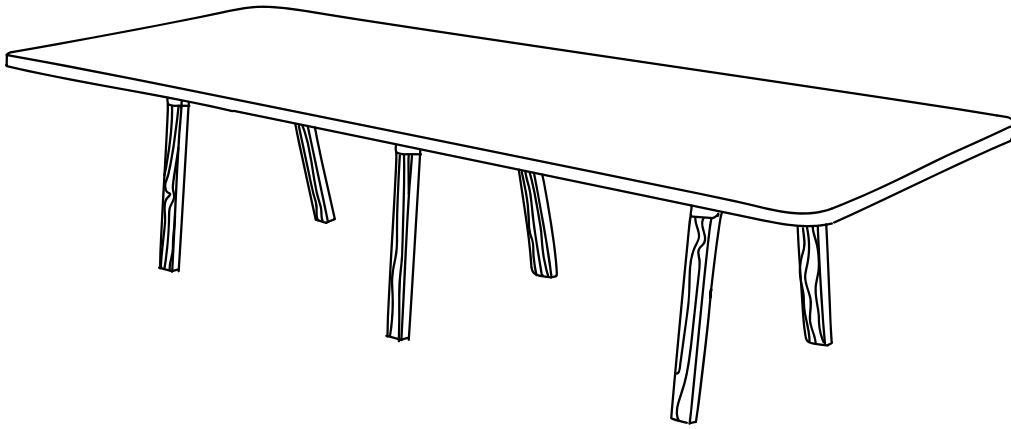

**simple**  
**natural**  
**managerial**

# Atreo

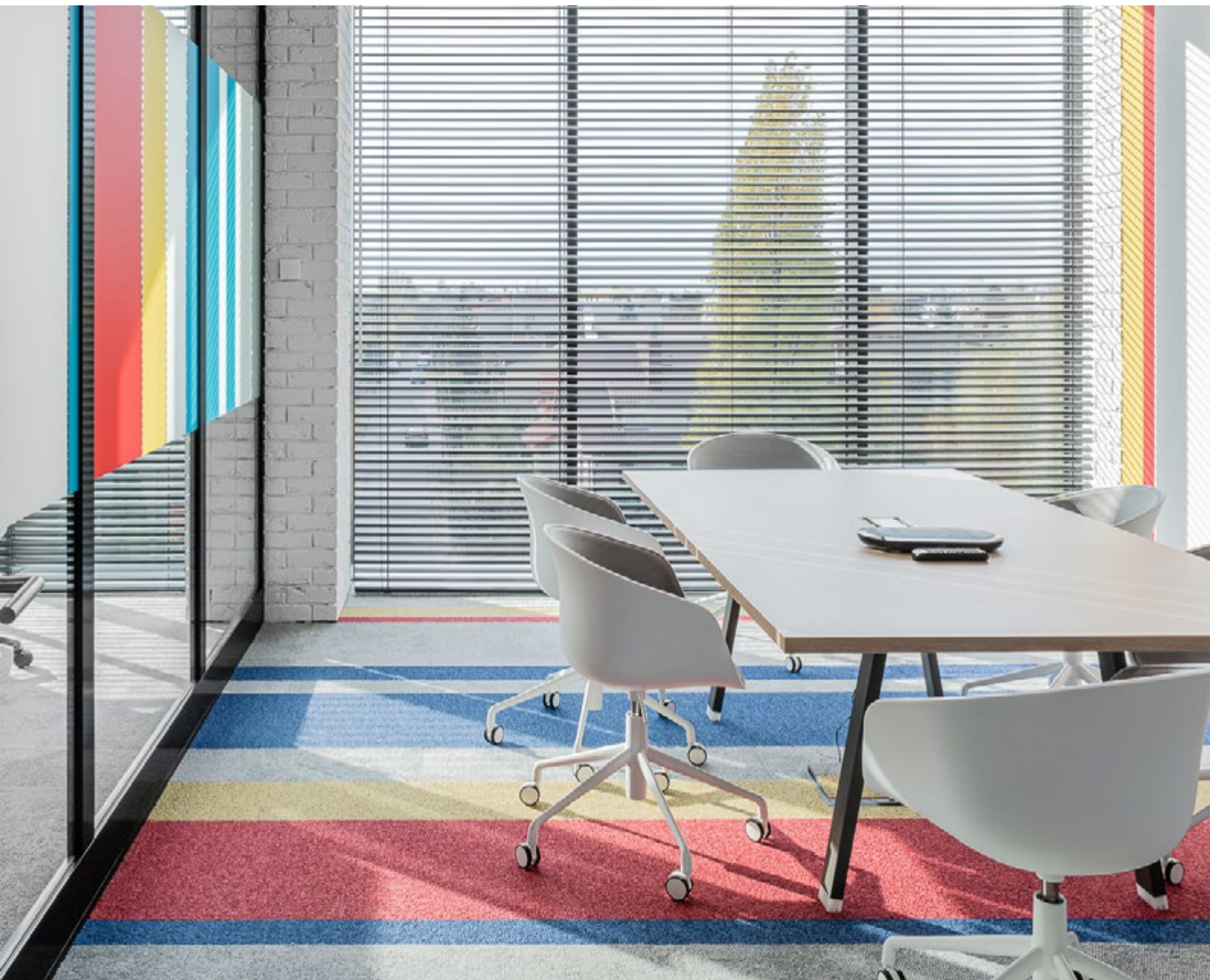

“ I tavoli riunione Atreo possono offrire due possibilità per la scelta della gamba, che può essere a cavalletto o a ponte. ”



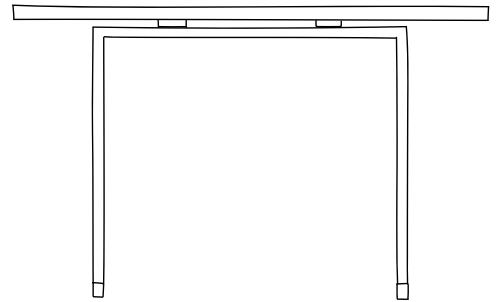
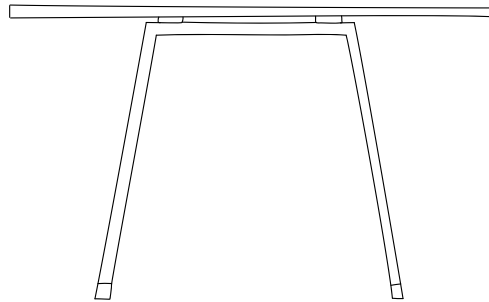





Atreo meeting tables offer two options for the choice of leg, which can be A-shaped or straight.

Les tables de réunion Atreo offrent deux options pour le choix du piètement, qui peut être à trapèze ou droit.

Las mesas de reuniones Atreo ofrecen dos opciones para la elección de la pata, que puede ser de caballete o recta.

		<b>forme piano</b> top shapes formes de plateau formas de sobre	<b>con profilo</b> with profile avec profil con perfil			<b>cablaggio nascosto</b> hidden wiring câblage caché cableado oculto	<b>ambiente</b> environment ambiance ambiente
Atreo	30 mm			X	X		modern

**Piani** | Desk tops | Plateaux | Sobres

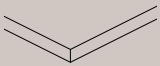

**Con angoli dritti**  
With straight corners  
Avec coins droits  
Con esquinas rectas



**Con angoli raggati**  
With rounded corners  
Avec coins arrondis  
Con esquinas redondeadas

**Gambe** | Legs | Pieds | Patas

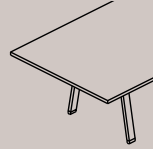

**A cavalletto**  
A-shape  
Tréteau  
Caballette

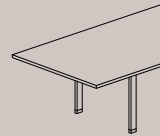

**A ponte**  
Straight  
Droit  
Recta

**Finiture** | Finishes | Finitions | Acabados

**Piano**  
Top  
Plateau  
Sobre



**Struttura**  
Structure  
Structure  
Estructura



**Tavoli riunione** | Meeting tables | Tables de réunion | Mesas de juntas

H 73.4 cm  
H 28 7/8"



Ø 90/100/120/130/150 cm  
Ø 35 3/8"-39 3/8"-47 1/4"-  
51 1/8"-59"

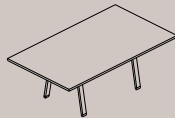

L 210/280 - P 120 cm  
W 82 5/8"-110 1/4" -  
D 47 1/4"

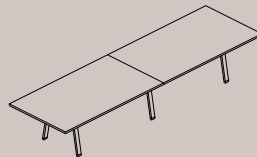

L 420/560 - P 120 cm  
W 165 3/8"-220 1/2" - D 47 1/4"



**modern**  
**linear**  
**simple**



# Blade



“ I tavoli Blade hanno un design fluido, caratterizzato dalla gamba a forma di lama, essenziale ed unica. I piani presentano una raggiatura sugli angoli per armonizzarsi completamente con la struttura. ”





Blade tables have a fluid design, characterized by the blade shaped leg, essential and unique. Tops have a radius on the corners to harmonize completely with the structure



Les tables Blade ont un design fluide, caractérisé par le pied en forme de lame, essentiel et unique. Les plateaux ont les coins arrondis afin de s'harmoniser complètement avec la structure.

Las mesas Blade tienen un diseño fluido, caracterizado por la pata en forma de hoja, esencial y único. Los sobres tienen un radiado en las esquinas para armonizar con la estructura.

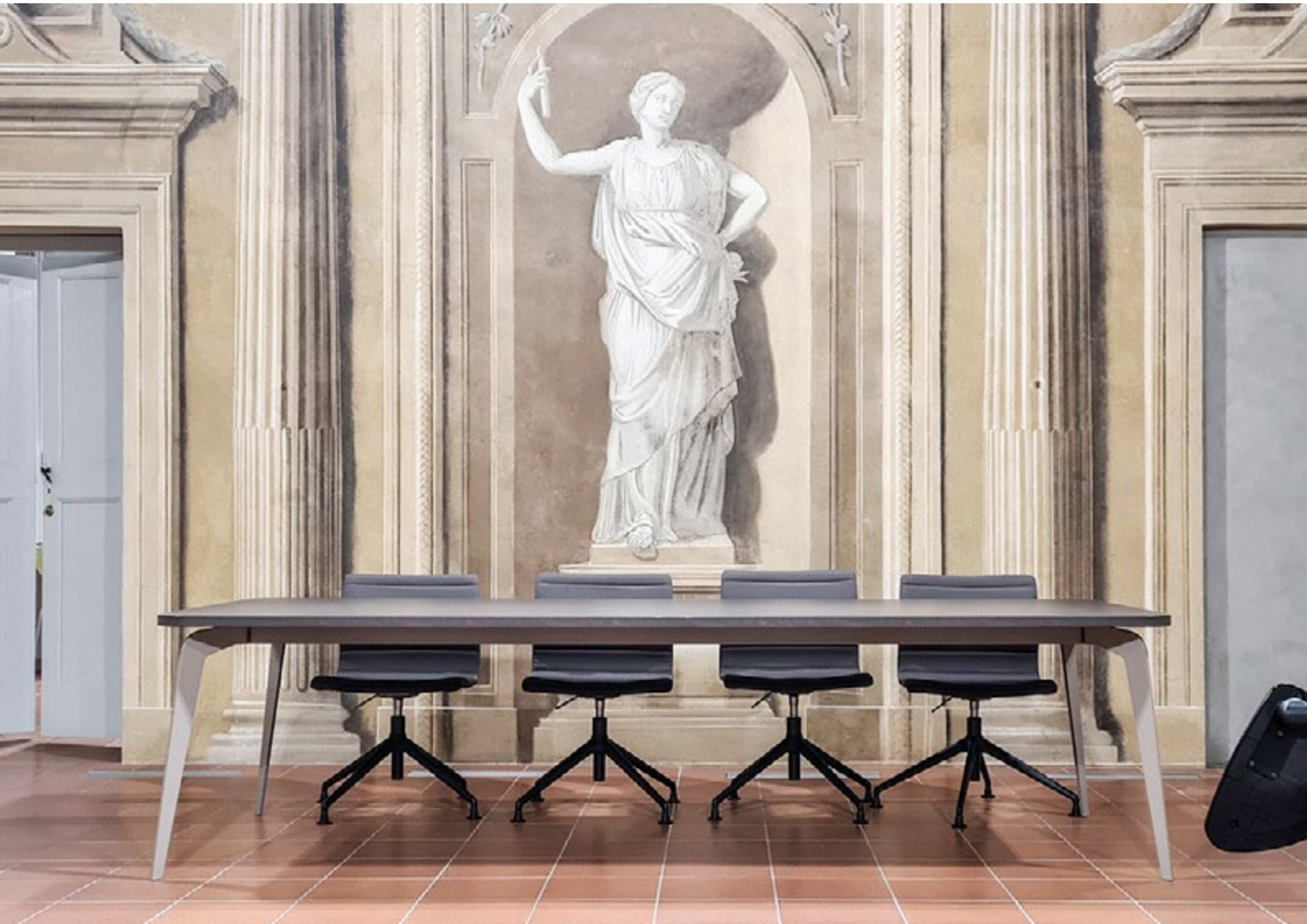

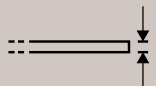
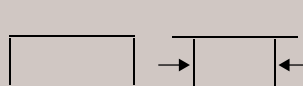

**managerial**  
**geometric**  
**classic**

		<b>forme piano</b> top shapes formes de plateau formas de sobre	<b>con profilo</b> with profile avec profil con perfil		<b>cablaggio nascosto</b> hidden wiring câblage caché cableado oculto	<b>ambiente</b> environment ambiance ambiente
Blade	30 mm				X	modern

**Piani** | Desk tops | Plateaux | Sobres

 **Con angoli raggiati**  
With rounded corners  
Avec coins arrondis  
Con esquinas redondeadas

**Gambe** | Legs | Pieds | Patas

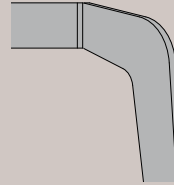

 **Spessore 1,2 cm**  
1,2 cm thick (1/2")  
1,2 cm d'épaisseur  
1,2 cm de espesor

**Finiture** | Finishes | Finitions | Acabados

**Piano**  
Top  
Plateau  
Sobre → **MEL**

**Struttura**  
Structure  
Structure  
Estructura → **EPX**

**Tavoli riunione** | Meeting tables | Tables de réunion | Mesas de juntas

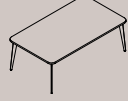
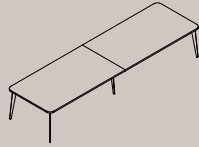
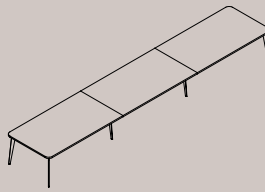
<b>H</b> 73,4 cm <b>H</b> 28 7/8"					
<b>Ø</b> 120/150 cm <b>Ø</b> 47 1/4"-59"	<b>L/P</b> 120/160 cm <b>W/D</b> 47 1/4"-63"	<b>L</b> 210/280 - <b>P</b> 120 cm <b>W</b> 82 5/8"-110 1/4" - <b>D</b> 47 1/4"	<b>L</b> 420/560 - <b>P</b> 120 cm <b>W</b> 165 3/8"-220 1/2" - <b>D</b> 47 1/4"	<b>L</b> 630 - <b>P</b> 120 cm <b>W</b> 248" - <b>D</b> 47 1/4"	

# Blade X



“ I tavoli Blade X hanno un design fluido, caratterizzato dalla gamba a forma di lama, essenziale ed unica. Il metallo può essere impreziosito da un rivestimento in legno massello oppure in cuoio, materiali che possono essere utilizzati anche sui piani. ”



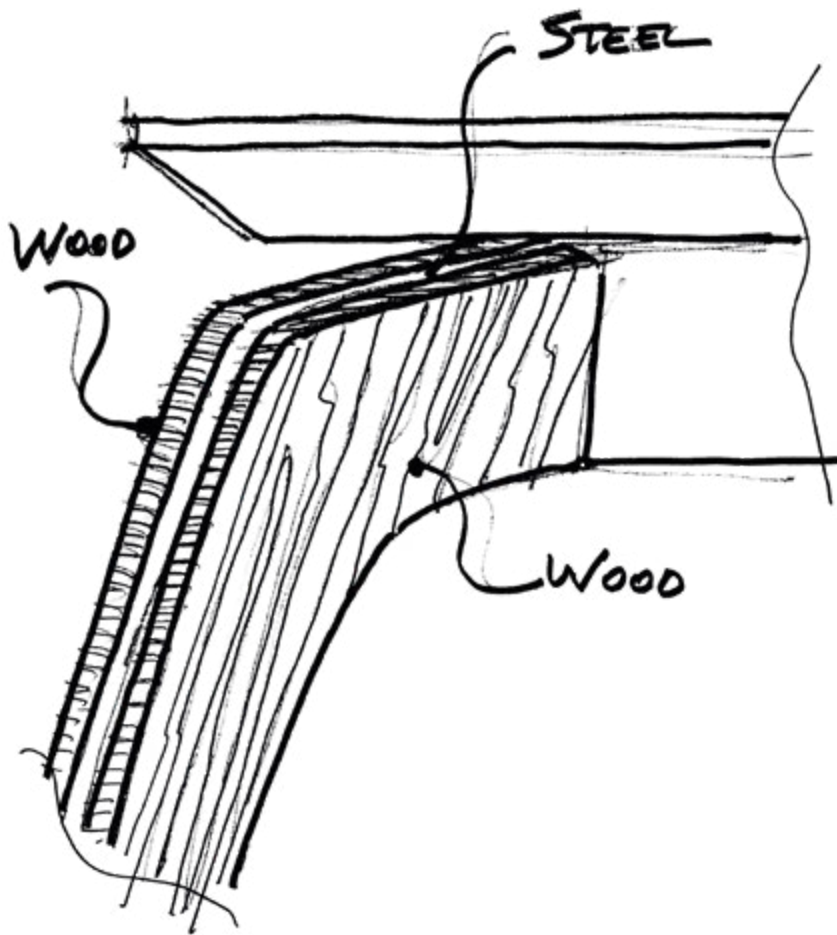

The Blade X tables have a fluid design, characterized by the blade-shaped leg, essential and unique. Metal can be embellished with solid wood or leather covers, materials that can also be used on worktops.

Les tables Blade X ont un design fluide, caractérisé par le pied en forme de lame, essentiel et unique. Le métal peut être embelli par des décorations en bois massif ou en cuir, matériaux qui peuvent également être utilisés sur les plateaux.

Las mesas Blade X tienen un diseño fluido, caracterizado por la pata en forma de hoja, esencial y único. El metal puede ser adornado con un recubrimiento en madera maciza o tapicería de cuero, materiales que también pueden ser utilizados en los sobres.





**managerial**  
**geometric**  
**classic**







Blade X

30 mm					X	managerial   classic
-------	--	--	--	--	---	----------------------

**Gambe | Legs | Pieds | Patas**

**Spessore 1,2 cm | 1,2 cm (1/2") thick | 1,2 cm d'épaisseur | 1,2 cm de espesor**

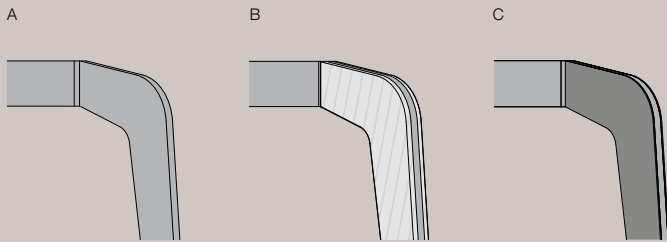

**A) Metallo verniciato epossidico B) Con rivestimento in legno C) Con rivestimento in cuoio**  
 A) Metal epoxy painted B) With wood veneer cover C) With leather cover  
 A) Métal peint époxy B) Avec revêtement en bois C) Avec revêtement en cuir  
 A) Metal pintado epoxi B) Con recubrimiento de madera C) Con recubrimiento de cuero

**Piani | Desk tops | Plateaux | Sobres**

**Spessore 3 cm | 3 cm (1 1/8") thick | 3 cm d'épaisseur | 3 cm de espesor**

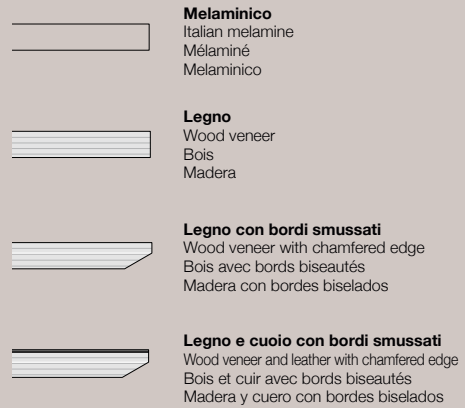

**Finiture | Finishes | Finitions | Acabados**

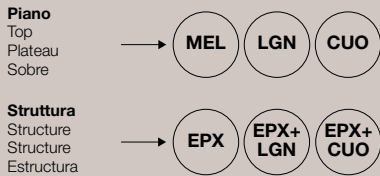

**Tavoli riunione | Meeting tables | Tables de réunion | Mesas de juntas**

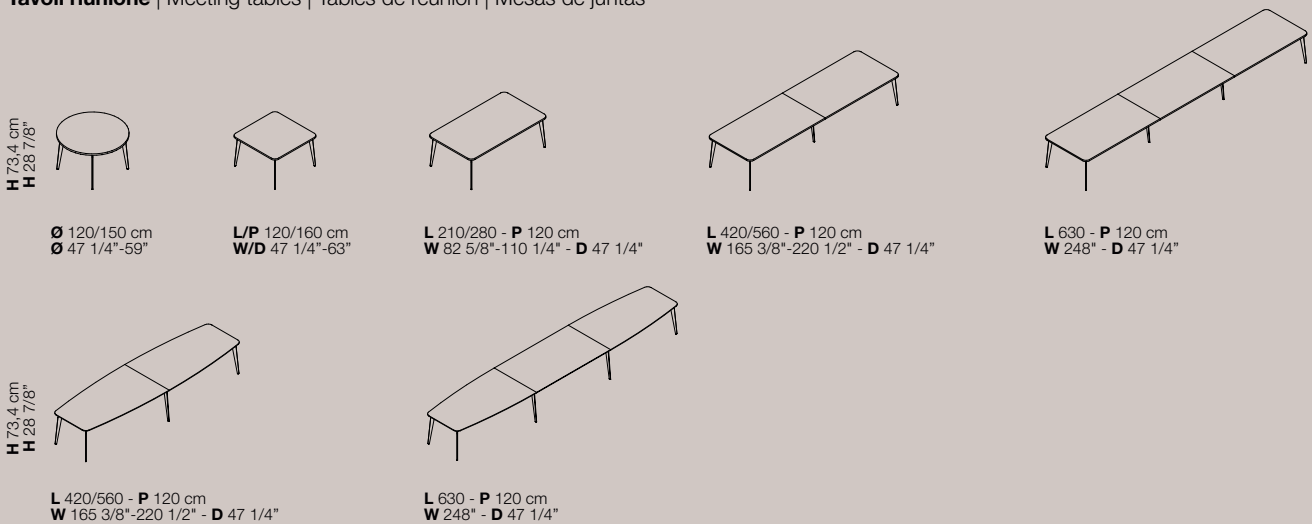

# Eracle



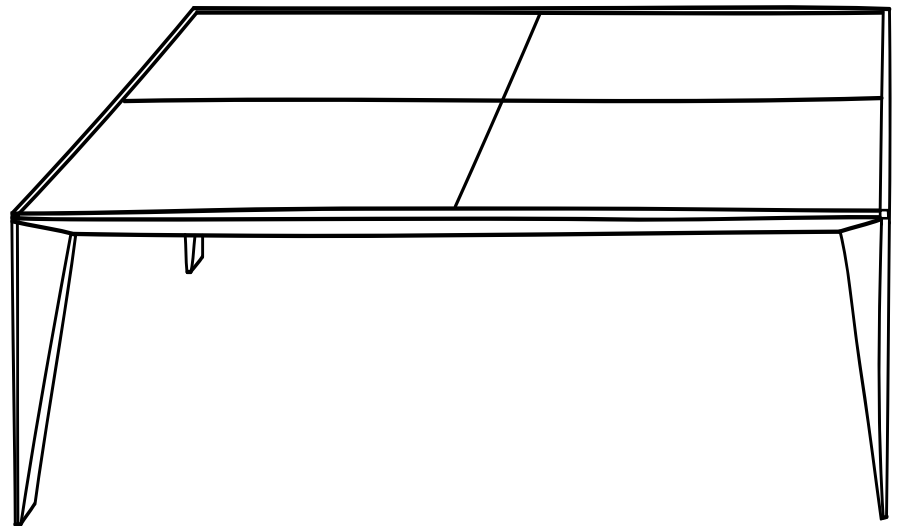

“ Eracle è una collezione che è caratterizzata dalla forte presenza dell'alluminio nella sua struttura. Questo materiale valorizza la particolare forma a diamante delle gambe innalzando il prodotto ad un design non convenzionale. ”

Eracle is a collection that is characterised by the strong presence of aluminium in its structure. This material enhances the distinctive diamond shape of the legs, elevating the product to unconventional design.

Eracle est une collection qui se caractérise par la forte présence de l'aluminium dans sa structure. Ce matériau met en valeur la forme distinctive en diamant des pieds, élevant le produit à un niveau de design non conventionnel.

Eracle es una colección que se caracteriza por la fuerte presencia del aluminio en su estructura. Este material realza la peculiar forma de diamante de las patas, elevando el producto a un diseño poco convencional.



**classic**  
**institutional**  
**characteristic**

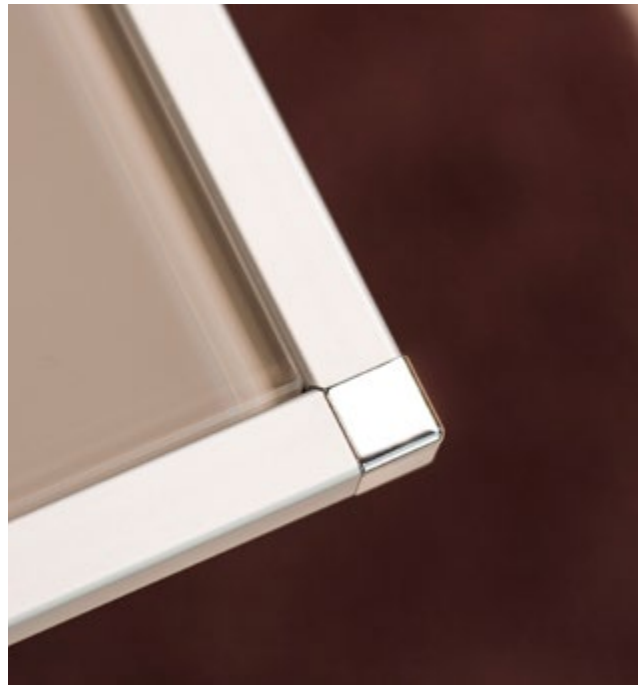

	<b>forme piano</b> top shapes formes de plateau formas de sobre	<b>con profilo</b> with profile avec profil con perfil		<b>cablaggio nascosto</b> hidden wiring câblage caché cableado oculto	<b>ambiente</b> environment ambiance ambiente		
Eracle	80 mm		X	X	X	X	classic

### Gambe | Legs | Pieds | Patas



**Gambe angolari - alluminio/cuoio**  
Corner legs - aluminium/leather  
Piètements d'angle - aluminium/cuir  
Patas angulares - aluminio/cuero



**Basamento a diamante - alluminio**  
Diamond-shaped base - aluminium  
Base à diamant - aluminium  
Base en forma de diamante - aluminio

### Finiture | Finishes | Finitions | Acabados

**Piano**  
Top  
Plateau  
Sobre

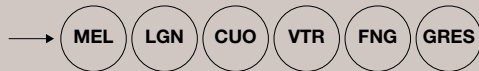

**Struttura**  
Structure  
Structure  
Estructura



### Tavoli riunione | Meeting tables | Tables de réunion | Mesas de juntas

H 73,4 cm  
H 28 7/8"



L/P 120/150/200 cm  
W/D 47 1/4"-59"-78 3/4"

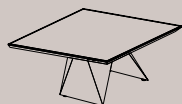

L/P 150 cm  
W/D 59"

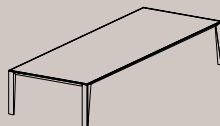

L 240/300 - P 120 cm  
W 94 1/2"-118 1/8" D 47 1/4"

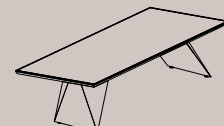
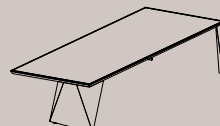

# Ibis



“ I tavoli riunione della collezione Ibis sono caratterizzati dal basamento incrociato in tubolare dalla sezione quadrata. ”



The meeting tables of the Ibis collection are characterised by a crossed tubular base with a square section.

Les tables de réunion de la collection Ibis se caractérisent par un piètement tubulaire croisé de section carrée.

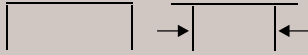
Las mesas de reunión de la colección Ibis se caracterizan por una base tubular cruzada de sección cuadrada.

		<b>forme piano</b> top shapes formes de plateau formas de sobre	<b>con profilo</b> with profile avec profil con perfil		<b>cablaggio nascosto</b> hidden wiring câblage caché cableado oculto	<b>ambiente</b> environment ambiance ambiente
Ibis	30 mm			X		modern

**Gambe** | Legs | Pieds | Patas

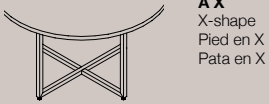

**Finiture** | Finishes | Finitions | Acabados

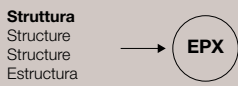
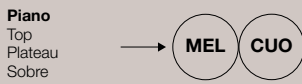

**Tavoli riunione** | Meeting tables | Tables de réunion | Mesas de juntas

H 73,4 cm  
H 28 7/8"



Ø 100/120/150 cm  
Ø 39 3/8"-47 1/4"-59"

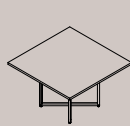

L/P 120 cm  
W/D 47 1/4"

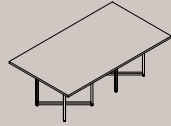

L 210/280 - P 120 cm  
W 82 5/8"-110 1/4" - D 47 1/4"

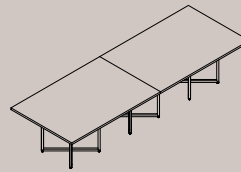

L 350 - P 120 cm  
W 137 3/4" - D 47 1/4"



# Italo\_forty



“ I tavoli Italo\_forty sono caratterizzati dall'innovativo sistema di fissaggio dei piani alla struttura metallica, solida e performante. Italo\_forty consente di realizzare tavoli riunione fino a 300 cm di lunghezza senza ricorrere all'utilizzo di supporti intermedi. ”





Italo\_forty tables are characterized by the innovative fixing system of the tops to the metal structure, solid and performing. Italo\_forty allows the creation of meeting tables up to 300 cm long without using intermediate supports.

Les tables Italo\_forty se caractérisent par le système innovant de fixation des plateaux à la structure métallique, solide et performante. Italo\_forty permet de réaliser des tables de réunion jusqu'à 300 cm de longueur sans utiliser de supports intermédiaires.

Las mesas Italo\_forty se caracterizan por el innovador sistema de fijación de los tableros a la estructura metálica, sólido y eficaz. Italo\_forty permite realizar mesas de reunión de hasta 300 cm de largo sin utilizar soportes intermedios.

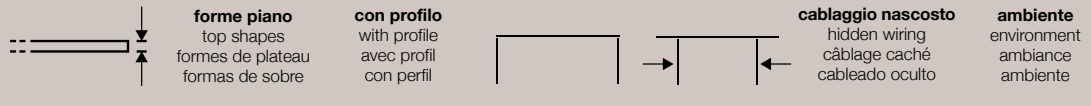

Italo_forty	8   18 mm			X			modern
-------------	-----------	--	--	---	--	--	--------

**Gambe | Legs | Pieds | Patas**

**Sezione 4x4 cm** | Section 4x4 cm (1 5/8"x 1 5/8") | Section 4x4 cm | Sección 4x4 cm

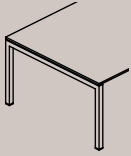

**Sezione quadrata**  
Square section  
Section carrée  
Sección cuadrada

**Finiture | Finishes | Finitions | Acabados**

**Piano**  
Top  
Plateau  
Sobre



**Struttura**  
Structure  
Structure  
Estructura



**Tavoli riunione | Meeting tables | Tables de réunion | Mesas de juntas**

H 73,4 cm  
H 28 7/8"

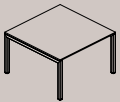

**L 120/160 - P 123/163 cm**  
**W 47 1/4"-63" - D 48 3/8"-64 1/8"**

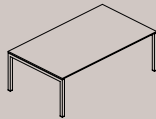

**L 210/240/300 - P 123 cm**  
**W 82 5/8"-94 1/2"-118 1/8" - D 48 3/8"**



**modern**  
**functional**  
**easy**

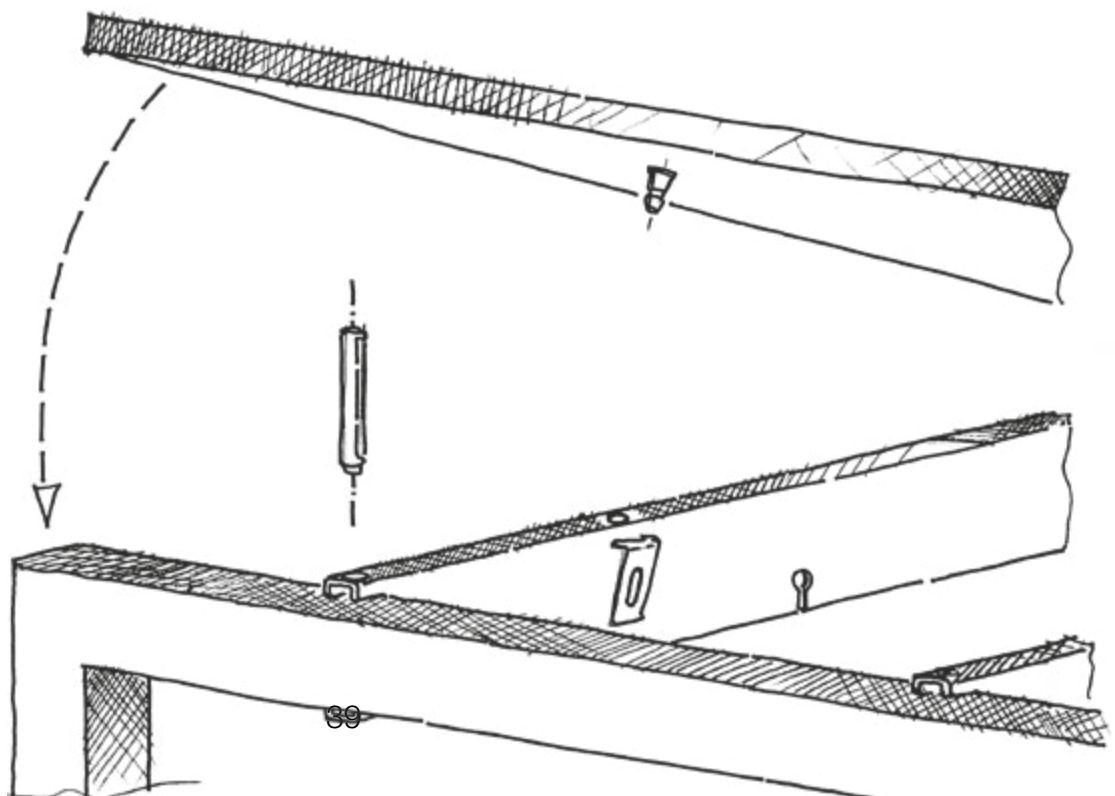

# Oasi



“ Il tavolo riunione Oasi è espressione di solidità ed eleganza. Due lame di metallo sostengono il piano che si spinge fino ad una lunghezza di 630 cm, disponibile in essenza legno. ”

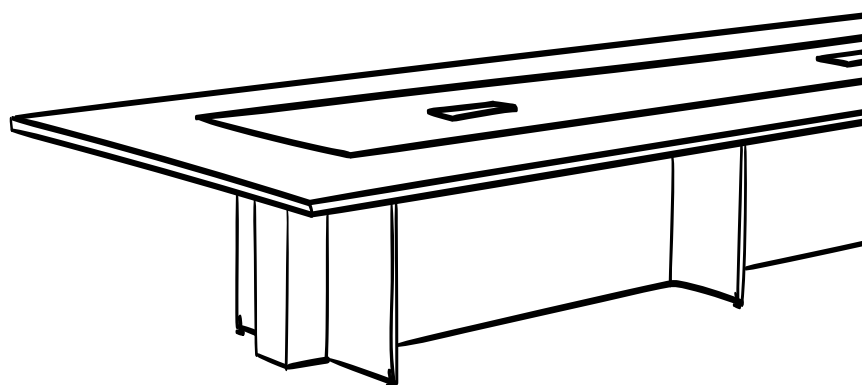



The Oasi meeting table is an expression of solidity and elegance. Two metal blades support the top that extends to a length of 630 cm, available in wood essence and melamine.

La table de réunion Oasi est l'expression de la grandeur et de l'élégance. Deux lames métalliques soutiennent le plateau qui s'étend sur une longueur de 630 cm, disponible en essence de bois et en mélaminé.

La mesa de reuniones Oasi es una expresión de solidez y elegancia. Dos láminas metálicas soportan el tablero que se extiende hasta una longitud de 630 cm, disponible en madera y melamina





**classic**  
**strong**  
**impressive**



	forme piano top shapes formes de plateau formas de sobre	con profilo with profile avec profil con perfil			cablaggio nascosto hidden wiring câblage caché cableado oculto	ambiente environment ambiance ambiente
Oasi	40 mm		X		X	classic

**Struttura** | Structure | Structure | Estructura

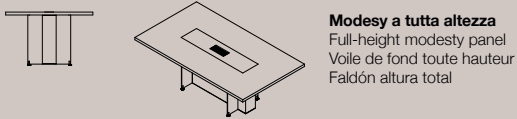

**Finiture** | Finishes | Finitions | Acabados

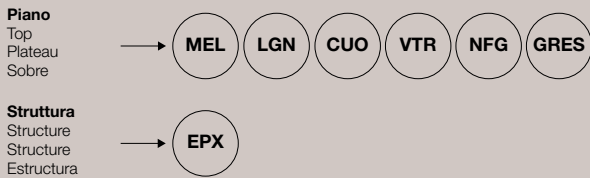

**Tavoli riunione** | meeting tables | tables de réunion | mesas de juntas

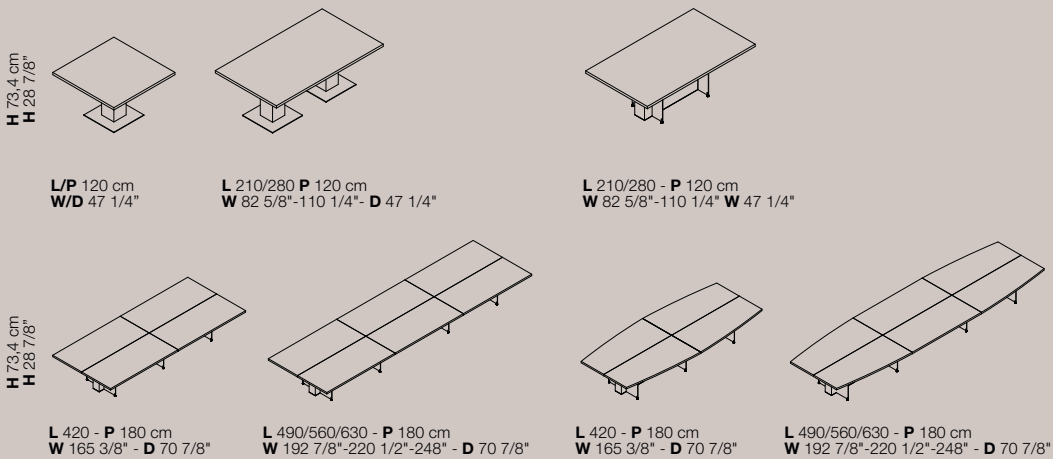



# Odeon



“ Odeon è una collezione classica che arriva a coprire dimensioni ampie per sale riunioni e conferenze. ”





Odeon is a classic collection that covers large dimensions for meeting and conference rooms.

Odeon est une collection classique qui couvre de grandes dimensions pour les salles de réunion et de conférence.

Odeon es una colección clásica que abarca grandes dimensiones para salas de reuniones y conferencias.



	<b>forme piano</b> top shapes formes de plateau formas de sobre	<b>con profilo</b> with profile avec profil con perfil			<b>cablaggio nascosto</b> hidden wiring câblage caché cableado oculto	<b>ambiente</b> environment ambiance ambiente
Odeon	40 mm		X	X	X	classic

**Gambe** | Legs | Pieds | Patas

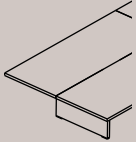

**Gambe pannellate spessore 4 cm**  
Panel legs 4 cm (1 5/8") thick  
Piètements panneaux 4 cm d'épaisseur  
Patas paneladas 4 cm de espesor

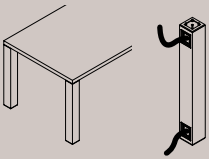

**Gambe angolari sezione 9x9 cm**  
Corner legs section 9x9 cm (3 1/2"x 3 1/2")  
Piètements d'angle section 9x9 cm  
Patas angulares sección 9x9 cm

**Finiture** | Finishes | Finitions | Acabados

**Piano**  
Top  
Plateau  
Sobre

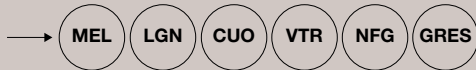

**Struttura**  
Structure  
Structure  
Estructura



**Tavoli riunione** | Meeting tables | Tables de réunion | Mesas de juntas

H 73,4 cm  
H 28 7/8"



L/P 80/90/100/120/130/150 cm  
W/D 31 1/2"-35 3/8"-39 3/8"-47 1/4"-51 1/8"-59"

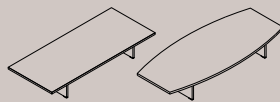

L 210/280 - P 120 cm  
W 82 5/8"-110 1/4" - D 47 1/4"

H 73,4 cm  
H 28 7/8"

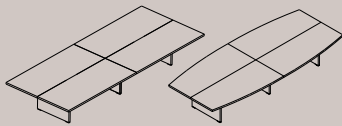

L 420 - P 180 cm  
W 165 3/8" - D 70 7/8"

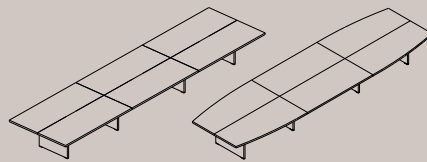

L 490/560/630 - P 180 cm  
W 192 7/8"-220 1/2"-248" - D 70 7/8"



**classic**  
**wood**  
**architectural**



# Ortho



“ Ortho presenta tavoli riunione semplici e funzionali. La struttura in metallo permette il passaggio dei cavi dal piano sino a terra rendendo l'ambiente ordinato. ”



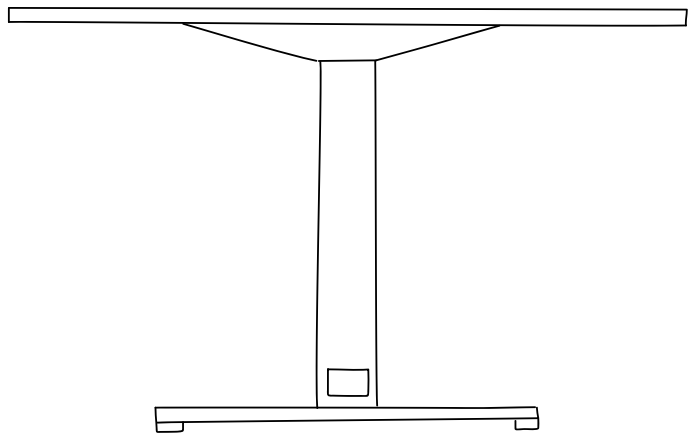

Ortho presents simple and functional meeting tables. The metal structure allows cable transit from the top to the ground, making the environment tidy.

Ortho présente des tables de réunion extrêmement simples et fonctionnelles. En effet, la structure métallique permet le passage des câbles. En rendant l'environnement propre.

Ortho presenta mesas de reuniones extremadamente simples y funcionales. De hecho, la estructura metálica permite el paso de los cables desde el sobre hasta el suelo, haciendo que el ambiente sea ordenado.

**modern**  
**technical**  
**pragmatic**



	forme piano top shapes formes de plateau formas de sobre	con profilo with profile avec profil con perfil			cablaggio nascosto hidden wiring câblage caché cableado oculto	ambiente environment ambiance ambiente	
Ortho	18   30 mm			X	X	X	modern

**Struttura** | Structures | Structures | Estructuras



**Struttura in metallo elettrificata, regolabile in altezza manualmente**  
 Electrified metal structure, manually height-adjustable  
 Structure en métal électrifiée, réglable manuellement en hauteur  
 Estructura metálica electrificada, regulable manualmente en altura

**Finiture** | Finishes | Finitions | Acabados

**Piano**  
 Top  
 Plateau  
 Sobre

→ **MEL**

**Struttura**  
 Structure  
 Structure  
 Estructura

→ **EPX**

**Tavoli riunione** | Meeting tables | Tables de réunion | Mesas de juntas

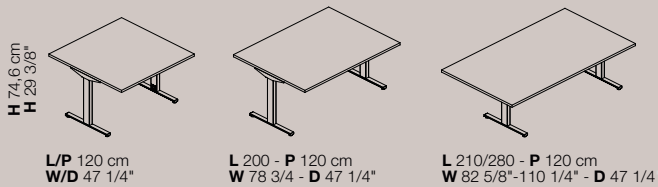

# Rendez-Vous

“ Rendez-Vous si distingue per il suo tratto sottile e slanciato. La struttura è in tubolare metallico (35 mm di diametro) e si raccorda al piano che è disponibile in diverse forme: rettangolare, rotondo, quadrato, a forma di 8 e ovale. ”







Rendez-Vous is distinguished by its slim and sleek design. The frame is made of tubular metal (35 mm in diameter) and is connected to the top, which is available in different shapes: rectangular, round, square, 8-shaped and oval.

Rendez-Vous se distingue par son design fin et élancé. Le cadre est en métal tubulaire (35 mm de diamètre) et est relié au plateau, qui est disponible en différentes formes: rectangulaire, rond, carré, en forme de 8 et ovale.

Rendez-Vous se destaca por su diseño fino y estilizado. La estructura es de metal tubular (35 mm de diámetro) y se fija al sobre, que está, disponible en distintas formas: rectangular, redonda, cuadrada, en forma de 8 y ovalada.



**forme piano**  
top shapes  
formes de plateau  
formas de sobre

**ambiente**  
environment  
ambiance  
ambiente

**cablaggio nascosto**  
hidden wiring  
câblage caché  
cableado oculto

**con profilo**  
with profile  
avec profil  
con perfil

Rendez-Vous

18 mm				modern		
-------	--	--	--	--------	--	--

**Finiture** | Finishes | Finitions | Acabados

**Piano**  
Top  
Plateau  
Sobre



**Struttura**  
Structure  
Structure  
Estructura



**Tavoli riunione** | Meeting tables | Tables de réunion | Mesas de juntas

H 73 4/90/105 cm  
H 28 7/8"-35 3/8"-41 3/8"



Ø 120/150 cm  
Ø 47 1/4"-59"

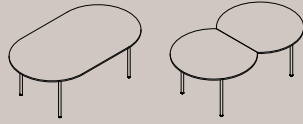

L 210/240 - P 120/140 cm  
W 82 5/8"-94 1/2" D 47 1/4"-55 1/8"

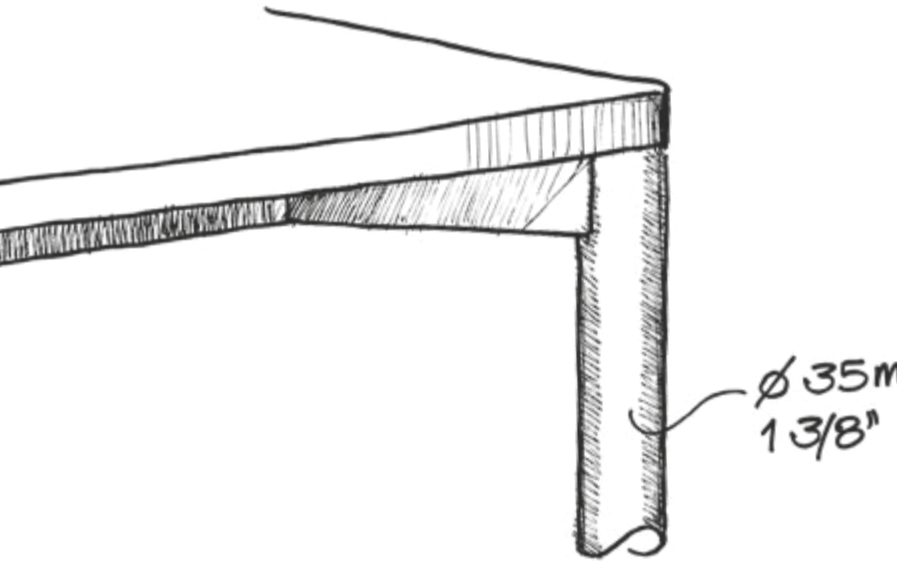

**modern**  
**flexible**  
**stylish**



# Titano

“ Titano presenta una serie di tavoli di forma rettangolare e sagomata, con piano unico oppure modulari. Questi ultimi possono arrivare ad una lunghezza di 840 cm. ”









Titano presents a series of rectangular and shaped tables, with single or modular top. The latter can reach a length of 840 cm.

Titano présente une série de tables rectangulaires et en forme tonneau, réalisées grâce à plateaux d'un seul tenant ou modulaires. Ce dernier peut atteindre une longueur de 840 cm.

Titano presenta una serie de mesas rectangulares y moldeadas, con sobre único o modulares. Este último puede alcanzar una longitud de 840 cm.



**classic**  
**strong**  
**wood**

		<b>forme piano</b> top shapes formes de plateau formas de sobre	<b>con profilo</b> with profile avec profil con perfil		<b>cablaggio nascosto</b> hidden wiring câblage caché cableado oculto	<b>ambiente</b> environment ambiance ambiente	
Titano	60 mm		X	X	X	X	classic

### Gambe | Legs | Pieds | Patas

Spessore 7,7 cm | 7,7 cm (3") thick | 7,7 cm d'épaisseur | 7,7 cm de espesor

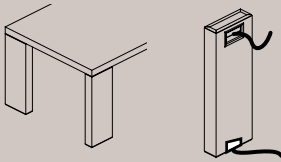

**Gambe angolari**  
Corner legs  
Piètements d'angle  
Patas angulares

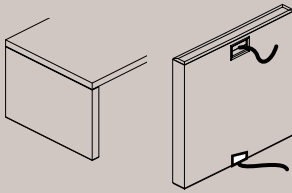

**Gambe pannellate**  
Panel legs  
Piètements panneaux  
Patas paneladas

### Finiture | Finishes | Finitions | Acabados

**Piano**  
Top  
Plateau  
Sobre



**Struttura**  
Structure  
Structure  
Estructura



### Tavoli riunione | Meeting tables | Tables de réunion | Mesas de juntas

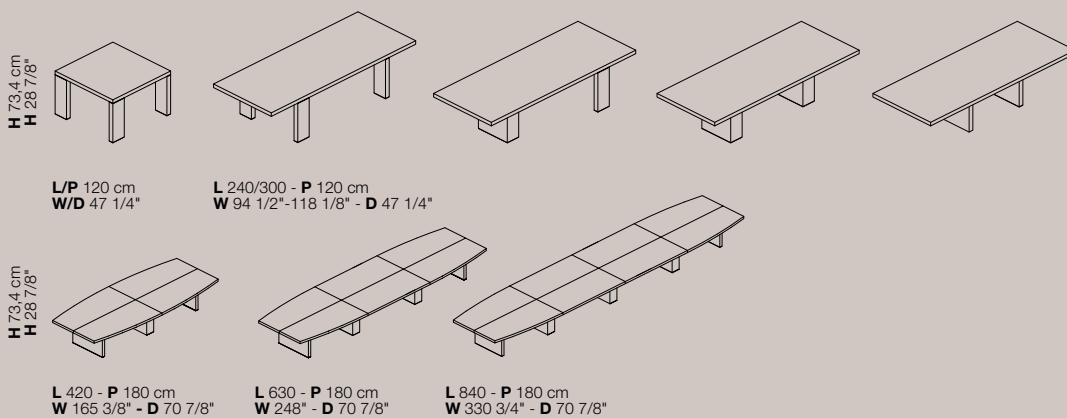

# Zefiro

— durable —  
— ever green —  
— classic —



“ Zefiro presenta una struttura in alluminio leggera, resistente e facilmente adattabile a diverse dimensioni. ”

Zefiro has a light structure made of aluminium, resistant and easily adaptable to different sizes.

Zefiro se caractérise par une structure en aluminium légère, solide et facilement adaptable à différentes tailles.

Zefiro presenta una estructura de aluminio ligera, resistente y fácilmente adaptable a diferentes tamaños.





	<b>forme piano</b> top shapes formes de plateau formas de sobre	<b>con profilo</b> with profile avec profil con perfil		<b>cablaggio nascosto</b> hidden wiring câblage caché cableado oculto	<b>ambiente</b> environment ambiance ambiente
Zefiro	12 mm		X	X	modern   managerial

**Gambe | Legs | Pieds | Patas**

**Sezione 5,4x5,4 cm** | Section 5,4x5,4 cm (2 1/8"x2 1/8") thick | Section 5,4x5,4 | Sección 5,4x5,4 cm

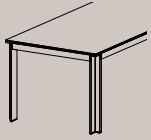

**Sezione a L**  
L section  
Section L  
Sección en L

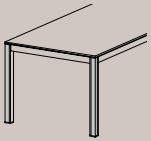

**Sezione a L con inserto in melaminico o legno**  
L section with Italian melamine or wood insert  
Section L avec insert en mélaminé ou bois  
Sección en L con inserto de melaminico o madera

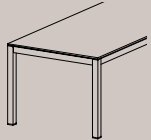

**Sezione quadrata**  
Square section  
Section carrée  
Sección cuadrada

**Finiture | Finishes | Finitions | Acabados**

**Piano**  
Top  
Plateau  
Sobre



**Struttura**  
Structure  
Structure  
Estructura



**Tavoli riunione | Meeting tables | Tables de réunion | Mesas de juntas**

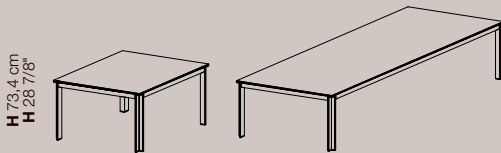

**L/P** 90/110 cm  
**W/D** 35 3/8"-43 1/4"

**L** 230/270 - **P** 110 cm  
**W** 90 1/2"-106 1/4" - **D** 43 1/4"

# Zefiro X



“ Zefiro X è un redesign in chiave moderna della collezione Zefiro, nei tavoli riunione i piani si allungano e nelle dimensioni più grandi vengono sostenuti da un supporto in metacrilato trasparente. ”

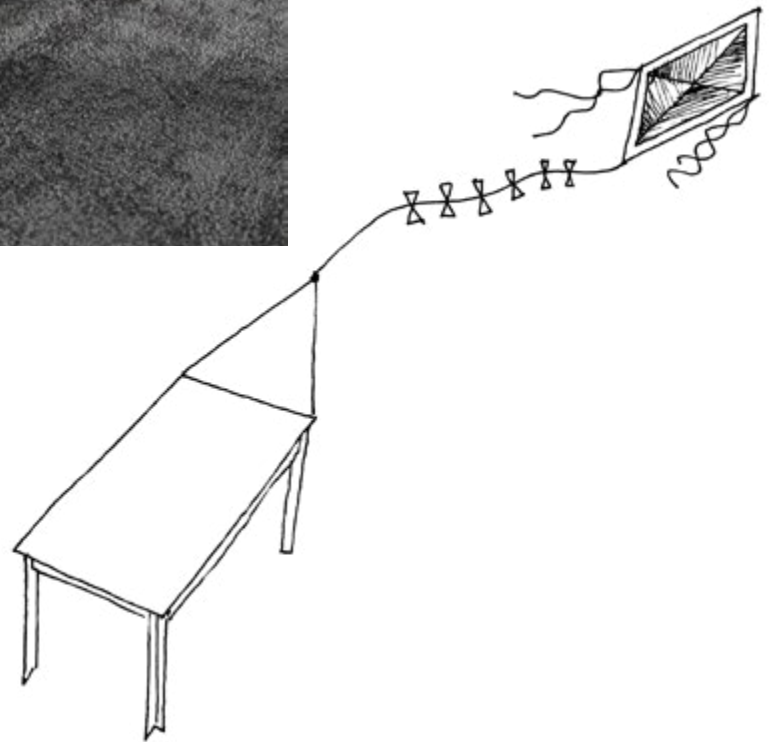

Zefiro X is a modern redesign of the Zefiro collection. In the meeting tables, tops are extended and in the larger sizes are supported by a transparent acrylic stand.

Zefiro X est une moderne design de la collection Zefiro. dans les tables de réunion, les plateaux s'allongent et dans les grandes tailles, ils sont soutenus par un support en méthacrylate transparent.

Zefiro X es un rediseño en clave modernade la colección Zefiro; en las mesas de reuniones los tableros se hacen más largos y en los tamaños más grandes se apoyan en una base de metacrilato transparente.





Zefiro X	10   12 mm		X	X	managerial
----------	------------	--	---	---	------------

**Gambe | Legs | Pieds | Patas**

**Sezione 5,4x5,4 cm** | Section 5,4x5,4 cm (2 1/8"x2 1/8") thick | Section 5,4x5,4 cm | Sección 5,4x5,4 cm

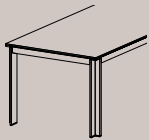

**Sezione a L in alluminio**  
L section, aluminium  
Section L, en aluminium  
Sección en L, en aluminio



**Sezione quadrata in alluminio**  
Square section, aluminium  
Section carrée, en aluminium  
Sección cuadrada, en aluminio

**Finiture | Finishes | Finitions | Acabados**

**Piano**  
Top  
Plateau  
Sobre



**Struttura**  
Structure  
Structure  
Estructura



**Basamenti per tavoli multipli L 400 cm** | Support for multiple tables W 400 cm (157 1/2") | Bases pour tables multiples L 400 cm | Bases para mesas múltiples L 400 cm

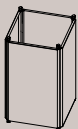

**Basamento ispezionabile in metallo verniciato epossidico**  
Inspectable epoxy painted metal basement  
Base inspectable métallique peinte à l'époxy  
Base inspeccionable metálica pintada con epoxi



**Basamento a croce in metacrilato trasparente**  
Cross transparent acrylic base  
Piètement en forme de croix en méthacrylate transparent  
Base en forma de cruz en metacrilato transparente

**Tavoli riunione | Meeting tables | Tables de réunion | Mesas de juntas**

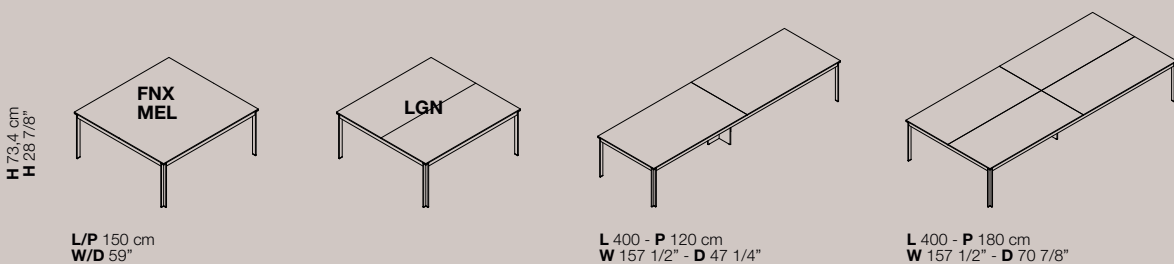
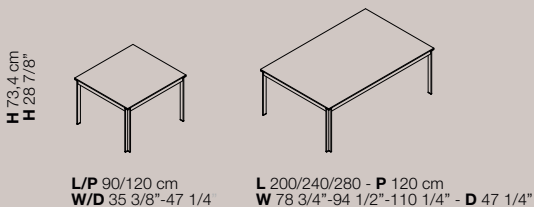





**linear**  
**design**  
**smart**

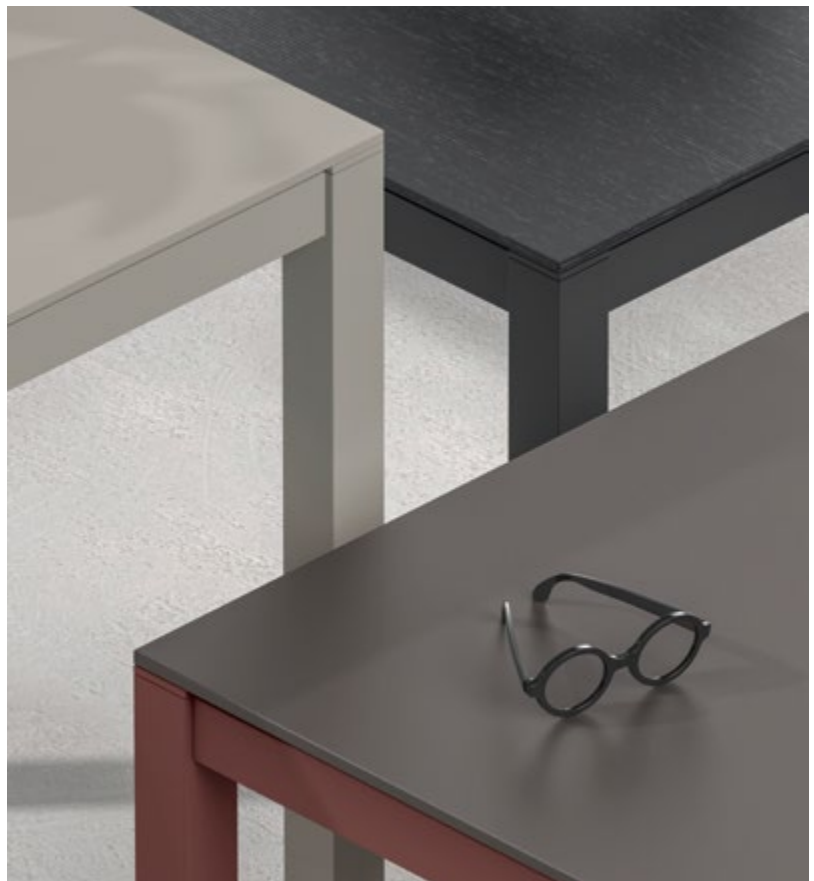

# Atlante

adaptable

easy

linear





“ La collezione Atlante  
comprende tavoli riunione  
semplici e lineari. ”

Atlante's collection includes  
simple and straightforward  
meeting tables.

La collection Atlante  
comprend des tables de  
réunion simples et linéaires.

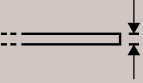
La colección Atlante incluye  
mesas de reuniones sencillas  
y lineales.

		<b>forme piano</b> top shapes formes de plateau formas de sobre	<b>con profilo</b> with profile avec profil con perfil		<b>cablaggio nascosto</b> hidden wiring câblage caché cableado oculto	<b>ambiente</b> environment ambiance ambiente
Atlante	30 mm				X	modern

**Finiture** | Finishes | Finitions | Acabados

**Piano**  
Top  
Plateau  
Sobre → 

**Struttura**  
Structure  
Structure  
Estructura → 

**Tavoli riunione** | Meeting tables | Tables de réunion | Mesas de juntas

**H** 73,4 cm  
**H** 28 7/8"  
  
**Ø** 100/120 cm  
**Ø** 39 3/8"-47 1/4"

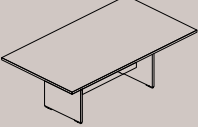
  
**L** 210/280 - **P** 120 cm  
**W** 82 5/8"-110 1/4" - **D** 47 1/4"

# Tavoli



“ I tavoli con basamento in metallo, si adattano ad ogni tipo di ambiente. I basamenti sono sia quadrati che circolari, e si abbinano a piani di diverse forme: quadrata, rettangolare, rotonda e a botte. ”





Tables with metal base, match any type of environment. Bases can be both square and circular, combined with tops of different shapes: square, rectangular, round, barrel shaped.

Les tables à base métallique, s'adaptent à tout type d'environnement. Les bases sont à la fois carrées et rondes, combinées avec des plateaux de différentes formes: carré, rectangulaire, rond, tonneau.

Las mesas con base de metal, son adecuadas para cualquier tipo de ambiente. Las bases son tanto cuadradas como redondas, combinadas con sobres de diferentes formas: cuadradas, rectangulares, redondas, de barril.

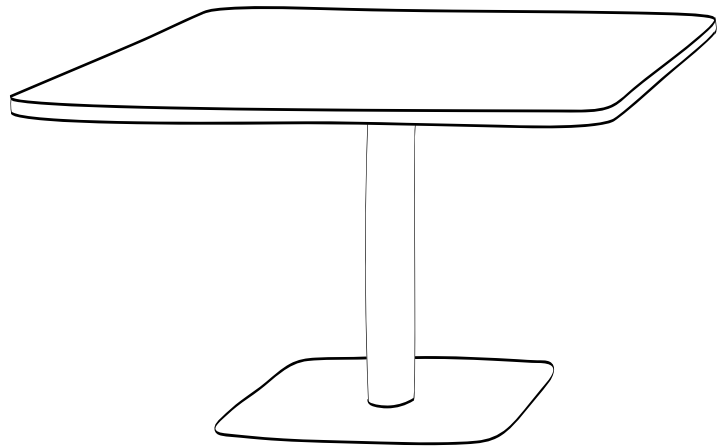



Tavoli con basamento	18   30   40   60 mm		X		X		modern   managerial
----------------------	-------------------------	--	---	--	---	--	------------------------

**Finiture** | Finishes | Finitions | Acabados

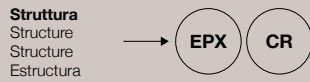
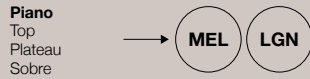

**Tavoli** | Tables | Tables | Mesas

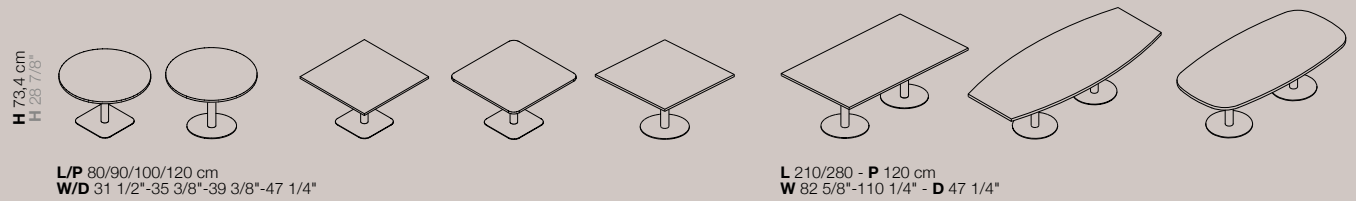



# materiali e finiture

Materials and finishes  
Matériaux et finitions  
Materiales y acabados





## MEL

### Melaminico

Melamine | Mélaminé | Melaminico

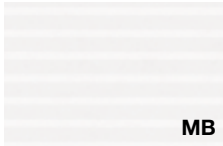

MB

#### Bianco rigato

Rippled effect white  
Blanc avec rayures en sérigraphie  
Blanco rayado

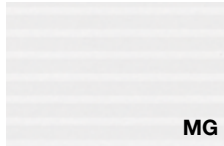

MG

#### Grigio rigato

Rippled effect grey  
Gris avec rayures en sérigraphie  
Gris rayado



MF

#### Nichel

Nickel  
Nickel  
Niquel



MZ

#### Cacao

Cocoa  
Cacao  
Cacao



MN

#### Bianco

White  
Blanc  
Blanco

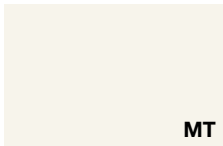

MT

#### Talco

Talco  
Talco  
Talco



MJ

#### Ocra

Ochre  
Ocre  
Ocre



SH

#### Terracotta

Terracotta  
Terre cuite  
Terracota



MK

#### Safari

Safari  
Safari  
Safari



MI

#### Noisette

Noisette  
Noisette  
Noisette



MV

#### Verde

Green  
Vert  
Verde



ML

#### Nero

Black  
Noir  
Negro



MQ

#### Blu notte

Night blue  
Bleu nuit  
Azul noche

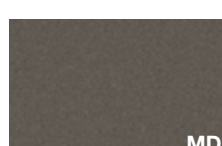

MD

#### Ardesia

Ardesia  
Ardesia  
Pizarra



MC

#### Rovere chiaro

Light oak  
Chêne clair  
Roble claro

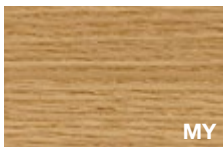

MY

#### Rovere americano

American oak  
Chêne américain  
Roble americano



ME

#### Rovere grigio

Grey oak  
Chêne gris  
Roble gris



MM

#### Rovere moro

Dark oak  
Chêne foncé  
Roble oscuro



MO

#### Noce Canaletto

Canaletto Walnut  
Noyer Canaletto  
Nogal Canaletto

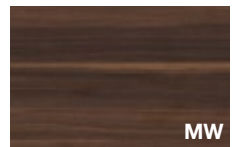

MW

#### Noce scuro

Dark walnut  
Noyer foncé  
Nogal oscuro

## LGN

### Legno

Wood | Bois | Madera

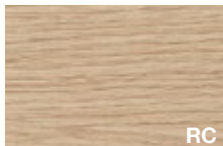

RC

#### Rovere chiaro

Light oak  
Chêne clair  
Roble claro

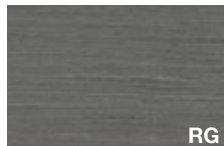

RG

#### Rovere grigio fumo

Smoke grey oak  
Chêne gris de fumée  
Roble gris humo



RM

#### Rovere moro

Dark oak  
Chêne foncé  
Roble oscuro

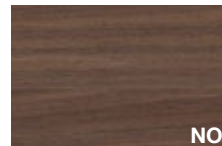

NO

#### Noce Canaletto

Canaletto Walnut  
Noyer Canaletto  
Nogal Canaletto



SL

#### Ebano Silver

Silver ebony  
Ebony Silver  
Ebano plata



AK

#### Ebano Makassar

Makassar ebony  
Ebony Makassar  
Ebano Makassar



NT

#### Noce termocotto

Heat-treated walnut  
Noyer thermo traité  
Nogal termotratado

## **FNX**

### **Fenix**

Fenix | Fenix | Fenix



**XE**

#### **Bianco**

White  
Blanc  
Blanco



**XD**

#### **Beige Arizona**

Arizona beige  
Beige Arizona  
Beige Arizona



**XF**

#### **Blu Fes**

Fes blue  
Bleu Fes  
Azul Fes



**XC**

#### **Grigio Bromo**

Bromo grey  
Gris Bromo  
Gris Bromo



**XV**

#### **Verde Comodoro**

Comodoro green  
Vert Comodoro  
Verde Comodoro

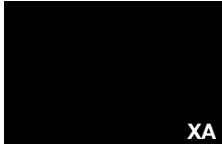

**XA**

#### **Nero**

Black  
Noir  
Negro



**XB**

#### **Rosso Jaipur**

Jaipur red  
Rouge Jaipur  
Rojo Jaipur

## **VTR**

### **Vetro (anche antimpronta NFG)**

Glass (also antifinger NFG) | Verre (également antitaches) | Vidrio (también anti-huella)



**GW**

#### **Bianco**

White  
Blanc  
Blanco

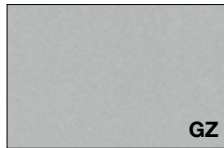

**GZ**

#### **Argento**

Silver  
Argent  
Plata



**GK**

#### **Grigio scuro**

Dark grey  
Gris foncé  
Gris oscuro



**GN**

#### **Noisette**

Noisette  
Noisette  
Noisette



**GA**

#### **Ardesia**

Ardesia  
Ardesia  
Pizarra

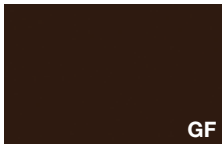

**GF**

#### **Moka**

Mocha  
Moka  
Cafe

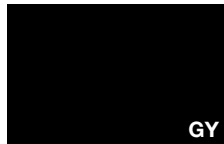

**GY**

#### **Nero**

Black  
Noir  
Negro



**GX**

#### **Arancione**

Orange  
Orange  
Naranja



**GQ**

#### **Rosso "F"**

Red "F"  
Rouge "F"  
Rojo "F"



**GO**

#### **Rubino**

Ruby  
Rubis  
Rubi



**GD**

#### **Indaco**

Indigo  
Indigo  
Azul Indigo



**GT**

#### **Azzurro**

Blue  
Bleu  
Azul



**GU**

#### **Verde**

Green  
Vert  
Verde



**GR**

#### **Cedro**

Lime green  
Vert Cédrat  
Verde Cedro

## **GRES**

### **Gres porcellanato**

Porcelain tiles | Grès cérame | Gres porcelánico



**Nero**  
Black  
Noir  
Negro

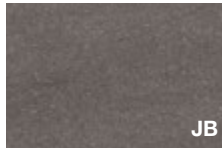

**Basalt**  
Basalt  
Basalt  
Basalt

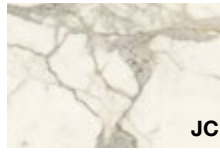

**Calacatta**  
Calacatta  
Calacatta  
Calacatta



**Pulpis**  
Pulpis  
Pulpis  
Pulpis



**Corten**  
Corten  
Corten  
Corten

## **CUO**

### **Cuoio**

Leather | Cuir | Cuero

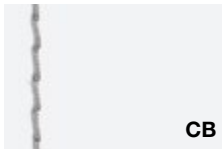

**Bianco**  
White  
Blanc  
Blanco



**Alluminio**  
Aluminium  
Aluminium  
Aluminio



**Nero**  
Black  
Noir  
Negro



**Testa di moro**  
Brown  
Tete de maure  
Marron oscuro



**Caramello**  
Caramel  
Caramel  
Caramelo



**Arancione**  
Orange  
Orange  
Naranja

## **GRES**

### **Gres porcellanato**

Porcelain tiles | Grès cérame | Gres porcelánico

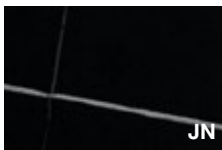

**Nero**  
Black  
Noir  
Negro



**Basalt**  
Basalt  
Basalt  
Basalt



**Calacatta**  
Calacatta  
Calacatta  
Calacatta



**Pulpis**  
Pulpis  
Pulpis  
Pulpis



**Corten**  
Corten  
Corten  
Corten



**OSB**

OSB | OSB | OSB



**OSB**  
OSB  
OSB  
OSB



## **EPX**

### **Epossidico**

Epoxy | Époxy | Epoxi



**EB**

#### **Bianco**

White  
Blanc  
Blanco

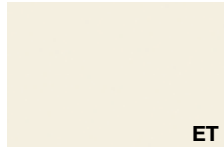

**ET**

#### **Talco**

Talco  
Talco  
Talco



**EG**

#### **Grigio**

Grey  
Gris  
Gris



**YD**

#### **Beige Arizona**

Arizona beige  
Beige Arizona  
Beige Arizona



**EO**

#### **Noisette**

Noisette  
Noisette  
Noisette



**EK**

#### **Safari**

Safari  
Safari  
Safari



**EE**

#### **Rame**

Copper  
Cuivre  
Cobre



**YB**

#### **Rosso Jaipur**

Jaipur red  
Rouge Jaipur  
Rojo Jaipur



**EZ**

#### **Bronzo**

Bronze  
Bronze  
Bronze



**YQ**

#### **Blu notte**

Night blue  
Bleu nuit  
Azul noche



**YC**

#### **Grigio Bromo**

Bromo grey  
Gris Bromo  
Gris Bromo

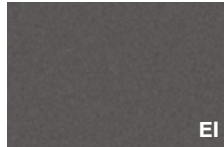

**EI**

#### **Ardesia**

Ardesia  
Ardesia  
Pizarra



**YV**

#### **Verde Comodoro**

Comodoro green  
Vert Comodoro  
Verde Comodoro

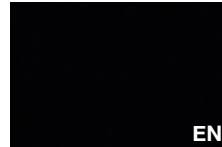

**EN**

#### **Nero**

Black  
Noir  
Negro

## **CRM**

### **Acciaio inox**

Stainless steel | Acier inoxydable | Acero inoxidable



**CR**

#### **Lucido**

Polished  
Poli  
Pulido

## **BR**

### **Brill**

Brill | Brill | Brill



**BR**

#### **Brill**

Brill  
Brill  
Brill

## **AL**

### **Alluminio**

Aluminium | Aluminium | Aluminio



**AL**

#### **Alluminio**

Aluminium  
Aluminium  
Aluminio

# Ambiente e sicurezza | Environment and safety | Environnement et sécurité | Medio ambiente y seguridad

Alea utilizza per i suoi prodotti e i suoi imballi materiali facilmente separabili e riciclabili.  
Nella produzione dei suoi manufatti, Alea si impegna ad utilizzare materiali legnosi FSC e pannelli a base di legno con certificazione CARB2. I pannelli CARB2 presentano un rilascio di formaldeide inferiore rispetto al pannello E1 comunemente utilizzato (classe E1 secondo il DM 10/10/2008).

Alea uses materials that are easy to separate and recycle for its products and packaging.  
Alea is committed to using FSC wood-based materials and CARB2-certified wood-based panels.  
CARB2 panels have a lower formaldehyde release than the commonly used E1 panel (class E1 according to DM 10/10/2008).

Alea utilise des matériaux facilement séparables et recyclables pour ses produits et ses emballages.  
Dans la production de ses produits, Alea s'engage à utiliser des matériaux en bois FSC et des panneaux à base de bois avec la certification CARB2. Les panneaux CARB2 dégagent moins de formaldéhyde que le panneau E1 couramment utilisé (classe E1 selon DM 10/10/2008).

Para sus productos y embalajes, Alea utiliza materiales fácilmente separables y reciclables.  
En la fabricación de sus productos, Alea se compromete a utilizar materiales de madera FSC y paneles de madera con certificación CARB2. Los paneles CARB2 tienen una menor liberación de formaldehído que el panel E1 comúnmente utilizado (clase E1 según DM 10/10/2008).

## **Concept, visual & graphic design**

Alea marketing + communication

### **Design**

-

### **Art direction**

-

## **Si ringrazia M.artedesign**

[martedesign.it](http://martedesign.it)

**Le finiture contenute nella stampa sono puramente indicative e non sono di riferimento per le forniture del prodotto**

Due to the printing process, finishes shown in this document are for illustration only. The finish on the final item may differ slightly from the printed illustration

Les finitions contenues dans l'impression sont purement indicatives et ne sont pas pertinentes pour les fournitures du produit

Los acabados contenidos en la impresión son puramente indicativos y no son de referencia para los suministros del producto



alea  
aleaoffice.com



**GLOBAL HEADQUARTERS AND SHOWROOM** : Via Col de Rust, 19 - 33070 Sarone (PN) - Italia : Tel ++39 0434 777 333  
email: info@aleaoffice.com **PARIS SHOWROOM** : 176 Avenue Charles de Gaulle 92200, Neuilly-sur-Seine - France **NORTH AMERICAN  
HEADQUARTERS** : Midtown 2, 3449 NE 1st Avenue L-32, Miami, FL 33137 - USA : Tel ++1 305 470 1200 - email: info@alea-usa.com  
**ALEA UK OFFICE AND SHOWROOM** : 50-54 Clerkenwell Road, London EC1M 5PS - email: info@aleaoffice.com