

alea

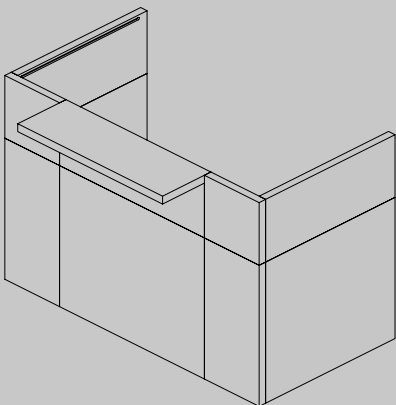

Philo

---

reception | receptions | accueils | recepciones

# PHILO

The PHILO reception counter comprises 40mm thick chipboard panels, available with different melamine finishes and in a variety of coloured lacquers. The front and side walls are divided into two joined vertical panels, providing creative colour combinations. The reception top is available in back-lacquered glass with an aluminium profile with polished brushed finish or wood finish.

La banque d'accueil PHILO est composée de panneaux en bois de 40 mm d'épaisseur, disponibles en différentes finitions de mélamine et en de nombreux coloris laqués. Les panneaux avant et latéraux sont formés de deux bandes verticales assemblées entre elles et permettant d'associer avec créativité plusieurs coloris. Le plateau supérieur est disponible en verre rétro laqué avec un profil en aluminium brossé brillant ou bien en finition bois.

Das Rezeptionspult PHILO besteht aus Holzplatten Stärke 40 mm, die in verschiedenen Melaminausführungen und vielen Farbblackierungen zur Auswahl stehen. Die vorderen und seitlichen Paneele sind in zwei senkrechte, miteinander verbundene Felder unterteilt, wodurch viele kreative Farbkombinationen möglich sind. Die Rezeptionsplatte steht in rückseitig lackiertem Glas mit Profil aus glänzendem gebürstetem Aluminium oder in Holz Ausführung zur Verfügung.

El banco de recepción PHILO utiliza paneles de madera de 40 mm de espesor disponibles en varios acabados melamínicos y en numerosos colores lacados. Las paredes frontales y laterales están divididas en dos franjas verticales unidas entre sí, lo que permite realizar creativas combinaciones de color. La encimera está disponible en cristal retrilacado con perfil de aluminio cepillado brillante o en acabado madera.

La reception PHILO utilizza pannelli lignei di spessore 40 mm disponibili in diverse finiture melaminiche e in molte colorazioni laccate. Le pareti frontali e laterali sono divise in due fasce verticali giuntate tra loro che permettono creative combinazioni di tinta. Il top reception è disponibile in vetro retrolaccato con profilo in alluminio spazzolato lucido oppure in finitura legno.



















In quanto autoportante, alla reception PHILO possono essere abbinate tutte le collezioni di tavoli Alea. I pannelli laterali sono dotati di profili dove agganciare accessori quali mensole, portacarte e portapenne. Il top reception può essere collocato in tre diverse posizioni: all'interno, a cavallo o all'esterno della paretina frontale.

As it is self-supporting, the PHILO reception counter can be matched with all Alea work desk collections. Side panels are equipped with profiles, where accessories can be attached, such as shelves, paper trays and pen holders. The reception top can be placed in three different positions: inside, across or outside the front wall.

Du moment qu'elle est autoportante, on peut associer à la banque d'accueil PHILO toutes les collections de plateaux Alea. Les panneaux latéraux sont dotés de profils sur lesquels on peut accrocher des accessoires comme des étagères, des range-dossiers et des porte-stylos. Le plateau supérieur peut être installé dans trois positions différentes par rapport au panneau avant: à l'intérieur, à cheval ou à l'extérieur.

Das selbsttragende Rezeptionspult PHILO lässt sich mit allen Tischkollektionen Alea kombinieren. Die seitlichen Paneele sind mit Profilen ausgestattet, in die Zubehörteile wie Borde, Aktenablagen und Stifthalter eingehakt werden können. Die Rezeptionsplatte kann in drei verschiedenen Positionen angebracht werden: auf der Innenseite, dazwischen liegend oder auf der Außenseite des vorderen Paneels.

Dado que es autoportante, el banco de recepción PHILO puede combinarse con todas las colecciones de mesas Alea. Los paneles laterales están dotados de perfiles para enganchar accesorios, como baldas, portapapeles y portabolígrafos. La encimera puede colocarse en tres posiciones distintas: dentro, sobrepuesta o fuera de la pared frontal.



Philo

















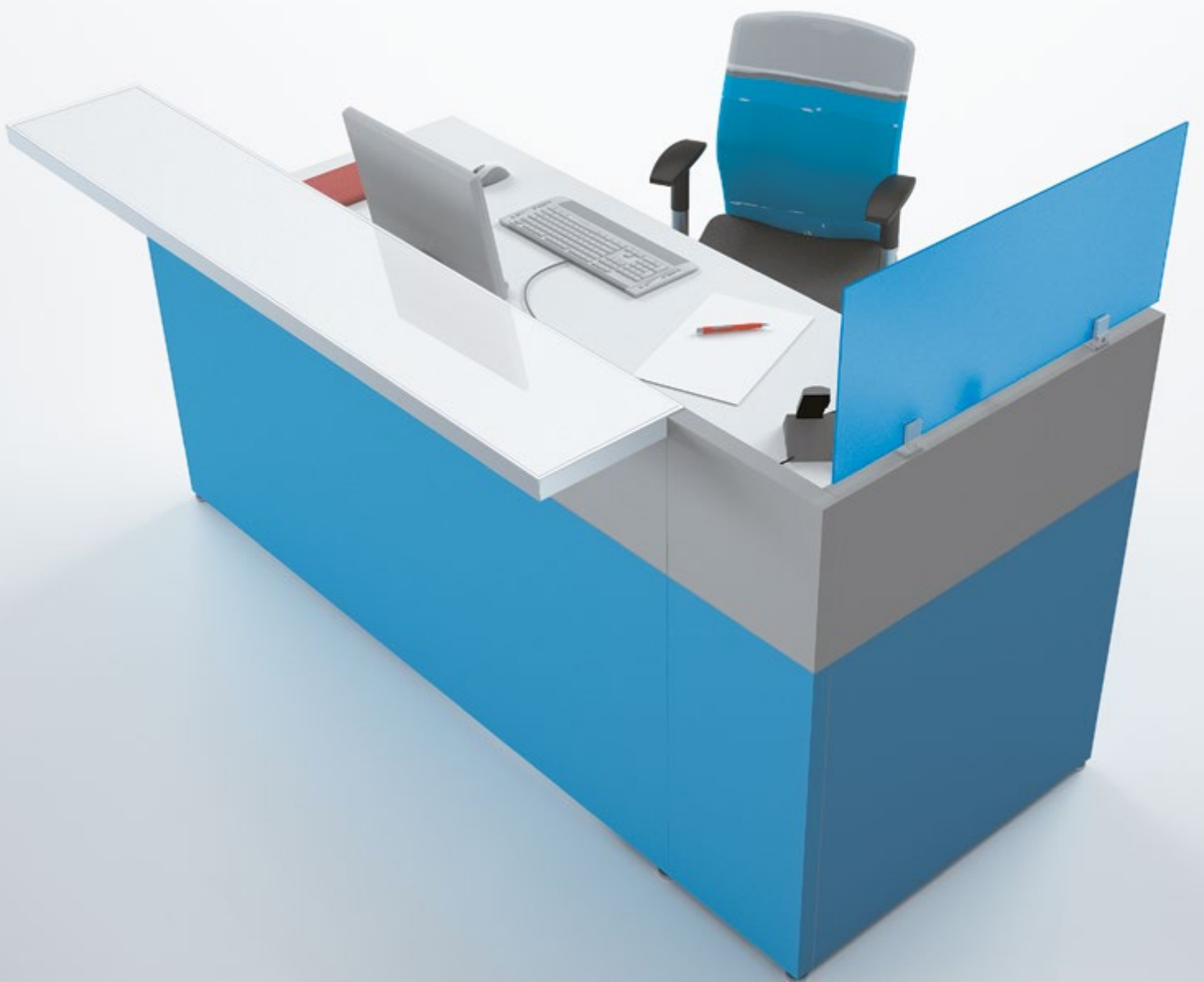







# Finiture | Finishes | Finitions | Acabados

## MEL

### Melaminico

Melamine | Mélaminé | Melaminico

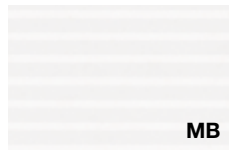

MB

#### Bianco rigato

Rippled effect white  
Blanc avec rayures en sérigraphie  
Blanco rayado

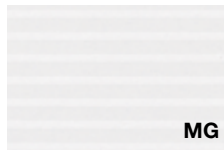

MG

#### Grigio rigato

Rippled effect grey  
Gris avec rayures en sérigraphie  
Gris rayado



MF

#### Nichel

Nickel  
Nickel  
Níquel



MZ

#### Cacao

Cocoa  
Cacao  
Cacao

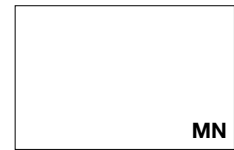

MN

#### Bianco

White  
Blanc  
Blanco

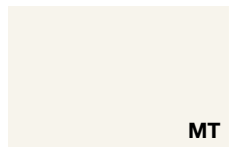

MT

#### Talco

Talco  
Talco  
Talco



MJ

#### Ocre

Ochre  
Ocre  
Ocre



MH

#### Terracotta

Terracotta  
Terre cuite  
Terracota



MK

#### Safari

Safari  
Safari  
Safari



MI

#### Noisette

Noisette  
Noisette  
Noisette



MV

#### Verde

Green  
Vert  
Verde



ML

#### Nero

Black  
Noir  
Negro



MQ

#### Blu notte

Night blue  
Bleu nuit  
Azul noche

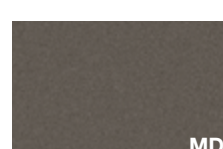

MD

#### Ardesia

Ardesia  
Ardesia  
Pizarra

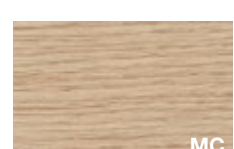

MC

#### Rovere chiaro

Light oak  
Chêne clair  
Roble claro



MY

#### Rovere americano

American oak  
Chêne américain  
Roble americano



ME

#### Rovere grigio

Grey oak  
Chêne gris  
Roble gris

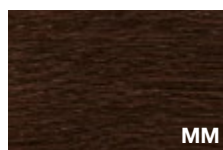

MM

#### Rovere moro

Dark oak  
Chêne foncé  
Roble oscuro

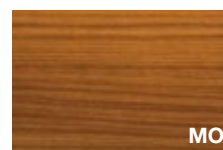

MO

#### Noce Canaletto

Canaletto Walnut  
Noyer Canaletto  
Nogal Canaletto



MW

#### Noce scuro

Dark walnut  
Noyer foncé  
Nogal oscuro

### Pannelli

Panels  
Panneaux  
Panelos

### Mensola reception

Reception top  
Support accueil  
Estante mostrador

## GOF

### Goffrato

Embossed | Gaufré | Gofrado



**Bianco**  
White  
Blanc  
Blanco



**Argento**  
Silver  
Argent  
Plata



**Grigio scuro**  
Dark grey  
Gris foncé  
Gris oscuro



**Noisette**  
Noisette  
Noisette  
Noisette



**Ardesia**  
Ardesia  
Ardesia  
Pizarra

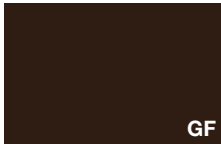

**Moka**  
Mocha  
Moka  
Cafe

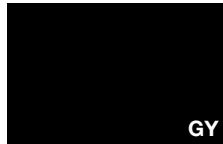

**Nero**  
Black  
Noir  
Negro



**Arancione**  
Orange  
Orange  
Naranja



**Rosso "F"**  
Red "F"  
Rouge "F"  
Rojo "F"



**Rubino**  
Ruby  
Rubis  
Rubi



**Indaco**  
Indigo  
Indigo  
Azul Indigo



**Azzurro**  
Blue  
Bleu  
Azul



**Verde**  
Green  
Vert  
Verde



**Cedro**  
Lime green  
Vert Cédrat  
Verde Cedro

### Piani vetro

Glass tops  
Plans en verre  
Sobres en cristal

## MTC

### Metacrilato

Acrylic | Méthacrylate | Metacrilato

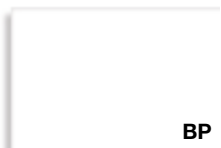

**Bianco opalino**  
Opaline white  
Blanc opalin  
Blanco opaco



**Trasparente**  
Transparent  
Transparent  
Transparente



**Rosso trasparente**  
Red transparent  
Rouge transparent  
Rojo transparente



**Blu trasparente**  
Blue transparent  
Bleu transparent  
Azul transparente



**Bianco satinato**  
Satin-finish white  
Blanc satiné  
Blanco satinado



**Grigio fumè satinato**  
Satin-finish smoky grey  
Gris satiné  
Gris satinado



**Arancione satinato**  
Satin-finish orange  
Orange satiné  
Naranja satinado



**Blu satinato**  
Satin-finish blue  
Bleu satiné  
Azul satinado



**Verde satinato**  
Satin-finish green  
Vert satiné  
Verde satinado



# Ambiente e sicurezza | Environment and safety | Environnement et sécurité | Medio ambiente y seguridad

**Ecologia:** Alea utilizza per i suoi prodotti e i suoi imballi materiali facilmente separabili e riciclabili. (Immagine 1)

**Catena Di Custodia COC:** Alea si impegna ad utilizzare materiali legnosi certificati FSC® e pannelli a base di legno con certificazione CARB2.

I pannelli CARB2 presentano un rilascio di formaldeide inferiore rispetto al pannello E1 comunemente utilizzato (classe E1 secondo il DM 10/10/2008).

I prodotti certificati FSC ® (License Code FSC-C118323) sono disponibili su richiesta: contattate i nostri uffici per maggiori informazioni. (Immagine 2)

**LEED:** Gli arredi di Alea possono contribuire al conseguimento del punteggio di certificazione LEED per i crediti indicati nei product badge. (Immagine 3)

**Sistemi di Gestione certificati ISO 9001, ISO 14001, ISO 45001:** Alea è attivamente impegnata nel raggiungere standard elevati di qualità e responsabilità attraverso l'adozione di sistemi di gestione certificati ISO per garantire prodotti e servizi di elevata qualità, in grado di soddisfare le aspettative dei clienti, di assicurare un ambiente di lavoro sicuro e di monitorare regolarmente l'impatto ambientale delle nostre attività. (Immagine 4)

**Attestazione di prodotto:** I prodotti Alea sono stati sottoposti a prove prestazionali presso laboratori di prova accreditati.

Copia dei rapporti di prova o delle attestazioni di conformità sono disponibili su richiesta. (Immagine 5)

**Eco-friendly:** Alea uses easily separable and recyclable materials for its products and packaging. (Image 1)

**Chain of Custody (COC):** Alea is committed to using FSC® certified wood materials and CARB2-certified wood-based panels. CARB2 panels have lower formaldehyde emissions compared to the commonly used E1 panels (class E1 according to the DM 10/10/2008). FSC® certified products (License Code FSC-C118323) are available upon request: please contact our offices for more information. (Image 2)

**LEED:** The A65 system can contribute to obtaining LEED certification points for the credits indicated in the product badges. (Image 3)

**ISO 9001, ISO 14001, ISO 45001 Certified Management Systems:** Alea is actively committed to achieving high standards of quality and responsibility through the adoption of ISO certified management systems to ensure high-quality products and services that meet customer expectations, provide a safe working environment, and regularly monitor the environmental impact of our activities. (Image 4)

**Product Certification:** Alea products have undergone performance tests by accredited testing laboratories. Copies of test reports or certificates of conformity are available upon request. (Image 5)



# Ambiente e sicurezza | Environment and safety | Environnement et sécurité | Medio ambiente y seguridad

**Écologie:** Alea utilise pour ses produits et ses emballages des matériaux facilement séparables et recyclables. (Image 1)

**Chaîne de contrôle COC:** Alea a à cœur d'utiliser des matériaux en bois certifiés FSC® et des panneaux à base de bois avec la certification CARB2.

Les panneaux CARB2 présentent une émission de formaldéhyde inférieure à celle des panneaux E1 couramment utilisés (classe E1 selon le DM 10/10/2008). Les produits certifiés FSC® (Code de licence FSC-C118323) sont disponibles sur demande : veuillez contacter nos bureaux pour plus d'informations. (Image 2)

**LEED:** Le système A65 peut contribuer à l'obtention des points de certification LEED pour les crédits indiqués dans les badges produits. (Image 3)

**Systèmes de gestion certifiés ISO 9001, ISO 14001, ISO 45001:** Alea s'engage activement à atteindre des normes élevées de qualité et de responsabilité à travers l'adoption de systèmes de gestion certifiés ISO pour garantir des produits et services de haute qualité, répondre aux attentes des clients, assurer un environnement de travail sûr et surveiller régulièrement l'impact environnemental de nos activités. (Image 4)

**Attestation de produit:** Les produits Alea ont été soumis à des tests de performance dans des laboratoires d'essais accrédités. Des copies des rapports de tests ou des certificats de conformité sont disponibles sur demande. (Image 5)

**Ecología:** Alea utiliza para sus productos y embalajes materiales fácilmente separables y reciclables. (Imagen 1)

**Cadena de Custodia COC:** Alea se compromete a utilizar materiales de madera certificados por FSC® y paneles a base de madera con certificación CARB2.

Los paneles CARB2 presentan una emisión de formaldehído inferior en comparación con los paneles E1 comúnmente utilizados (clase E1 según el DM 10/10/2008). Los productos certificados por FSC® (Código de Licencia FSC-C118323) están disponibles bajo solicitud: por favor contacte a nuestras oficinas para más información. (Imagen 2)

**LEED:** El sistema A65 puede contribuir a la consecución de la puntuación de certificación LEED para los créditos indicados en los product badges. (Imagen 3)

**Sistemas de Gestión Certificados ISO 9001, ISO 14001, ISO 45001:** Alea está comprometida activamente en alcanzar altos estándares de calidad y responsabilidad mediante la adopción de sistemas de gestión certificados por ISO para garantizar productos y servicios de alta calidad, que cumplen con las expectativas de los clientes, aseguran un entorno de trabajo seguro y monitorean regularmente el impacto ambiental de nuestras actividades. (Imagen 4)

**Certificación de Producto:** Los productos Alea han sido sometidos a pruebas de rendimiento en laboratorios acreditados. Las copias de los informes de prueba o los certificados de conformidad están disponibles bajo solicitud. (Imagen 5)



1.



2.



3.



4.



5.

**Fianco laterale terminale H.105**

- 6586

L. 50	9 11/16	Cod.0501051
L. 60	23 10/16	Cod.0601051
L. 70	27 9/16	Cod.0701051
L. 80	31 8/16	Cod.0801051
L. 90	35 7/16	Cod.0901051
L. 100	39 6/16	Cod.1001051
L. 110	43 5/16	Cod.1101051
L. 120	47 4/16	Cod.1201051
L. 130	51 3/16	Cod.1301051
L. 140	55 2/16	Cod.1401051
L. 150	59 1/16	Cod.1501051
L. 160	63	Cod.1601051
L. 170	66 15/16	Cod.1701051
L. 180	70 14/16	Cod.1801051
L. 190	74 13/16	Cod.1901051
L. 200	78 12/16	Cod.2001051
L. 210	82 11/16	Cod.2101051

**Fianco laterale terminale H.105**

- 6586

L. 50	9 11/16	Cod.0501052
L. 60	23 10/16	Cod.0601052
L. 70	27 9/16	Cod.0701052
L. 80	31 8/16	Cod.0801052
L. 90	35 7/16	Cod.0901052
L. 100	39 6/16	Cod.1001052
L. 110	43 5/16	Cod.1101052
L. 120	47 4/16	Cod.1201052
L. 130	51 3/16	Cod.1301052
L. 140	55 2/16	Cod.1401052
L. 150	59 1/16	Cod.1501052
L. 160	63	Cod.1601052
L. 170	66 15/16	Cod.1701052
L. 180	70 14/16	Cod.1801052
L. 190	74 13/16	Cod.1901052
L. 200	78 12/16	Cod.2001052
L. 210	82 11/16	Cod.2101052

**Pannello frontale intermedio H.105**

- 6587

L. 54	21 4/16	Cod.054105
L. 64	25 3/16	Cod.064105
L. 74	29 2/16	Cod.074105
L. 84	33 1/16	Cod.084105

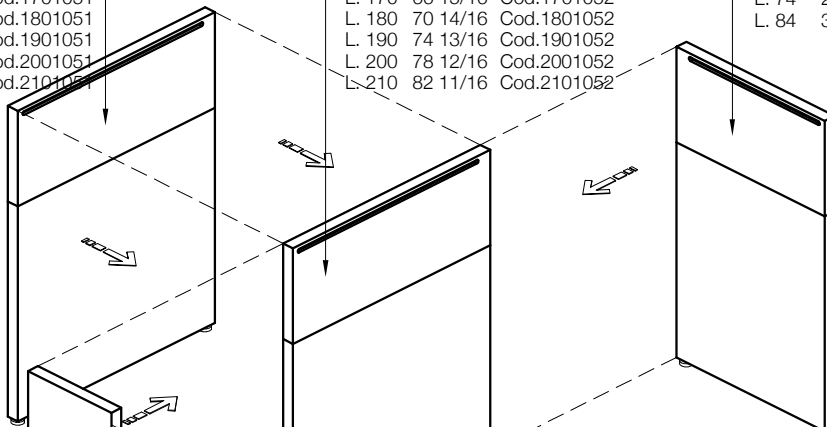

**Mensola H.105 - 6538**

L. 50	19 11/16	Cod.05003 / V
L. 60	23 10/16	Cod.06003 / V
L. 70	27 9/16	Cod.07003 / V
L. 80	31 8/16	Cod.08003 / V
L. 90	35 7/16	Cod.09003 / V
L. 100	39 6/16	Cod.10003 / V
L. 110	43 5/16	Cod.11003 / V
L. 120	47 4/16	Cod.12003 / V
L. 130	51 3/16	Cod.13003 / V
L. 140	55 2/16	Cod.14003 / V
L. 150	59 1/16	Cod.15003 / V
L. 160	63	Cod.16003 / V
L. 170	66 15/16	Cod.17003 / V
L. 180	70 14/16	Cod.18003 / V
L. 190	74 13/16	Cod.19003 / V
L. 200	78 12/16	Cod.20003 / V
L. 210	82 11/16	Cod.21003 / V

**Fianco per angolo 90° H.105 - 6585**

L. 34	13 6/16	Cod.0341052
-------	---------	-------------

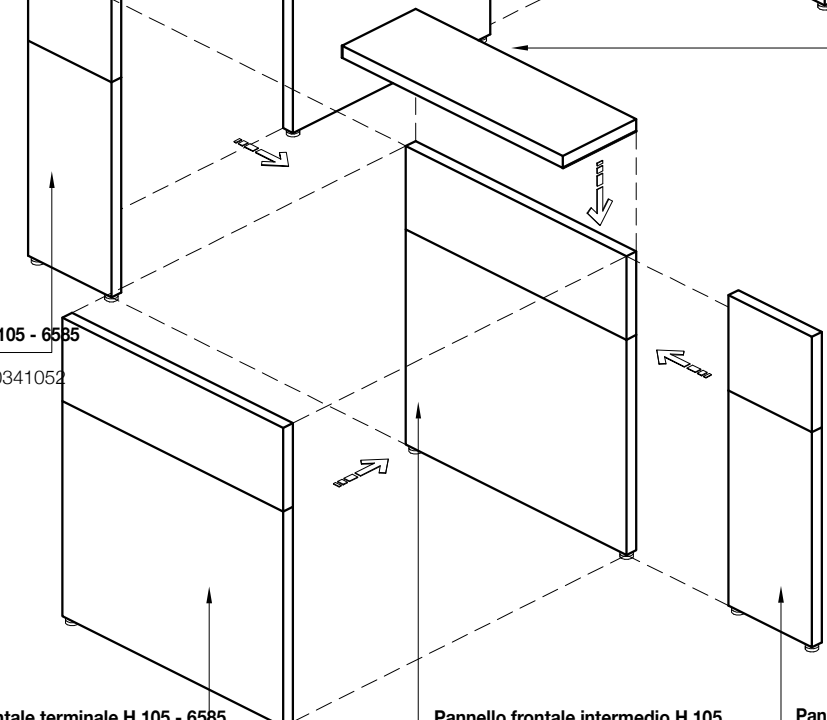

**Pannello frontale terminale H.105 - 6585**

L. 50	19 11/16	Cod.0501051
L. 60	23 10/16	Cod.0601051
L. 70	27 9/16	Cod.0701051
L. 80	31 8/16	Cod.0801051
L. 90	35 7/16	Cod.0901051
L. 100	39 6/16	Cod.1001051
L. 110	43 5/16	Cod.1101051
L. 120	47 4/16	Cod.1201051
L. 130	51 3/16	Cod.1301051
L. 140	55 2/16	Cod.1401051
L. 150	59 1/16	Cod.1501051
L. 160	63	Cod.1601051
L. 170	66 15/16	Cod.1701051
L. 180	70 14/16	Cod.1801051
L. 190	74 13/16	Cod.1901051
L. 200	78 12/16	Cod.2001051
L. 210	82 11/16	Cod.2101051

**Pannello frontale intermedio H.105 - 6585**

L. 50	19 11/16	Cod.0501052
L. 60	23 10/16	Cod.0601052
L. 70	27 9/16	Cod.0701052
L. 80	31 8/16	Cod.0801052
L. 90	35 7/16	Cod.0901052
L. 100	39 6/16	Cod.1001052
L. 110	43 5/16	Cod.1101052
L. 120	47 4/16	Cod.1201052
L. 130	51 3/16	Cod.1301052
L. 140	55 2/16	Cod.1401052
L. 150	59 1/16	Cod.1501052
L. 160	63	Cod.1601052
L. 170	66 15/16	Cod.1701052
L. 180	70 14/16	Cod.1801052
L. 190	74 13/16	Cod.1901052
L. 200	78 12/16	Cod.2001052
L. 210	82 11/16	Cod.2101052

**Pannello frontale terminale H.105 - 6585**

L. 34	13 6/16	Cod.0341051
-------	---------	-------------

**concept & graphic design**

Alea marketing + communication

**design**

Filippon & Mirto Antonel

**art direction**

Mirto Antonel

AF/CACB/AB





**GLOBAL HEADQUARTERS AND SHOWROOM** : Via Col de Rust, 19 - 33070 Sarone (PN) - Italia : Tel ++39 0434 777 333  
email: info@aleaoffice.com **PARIS SHOWROOM** : 176 Avenue Charles de Gaulle 92200, Neuilly-sur-Seine - France **NORTH AMERICAN**  
**HEADQUARTERS** : Midtown 2, 3449 NE 1st Avenue L-32, Miami, FL 33137 - USA : Tel ++1 305 470 1200 - email: info@alea-usa.com  
**ALEA UK OFFICE AND SHOWROOM** : 50-54 Clerkenwell Road, London EC1M 5PS - email: info@aleaoffice.com