

alea

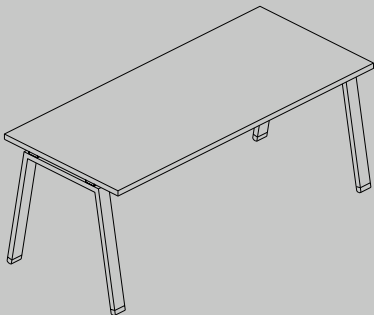

ATREO

operativi | workstations | systèmes | operativos

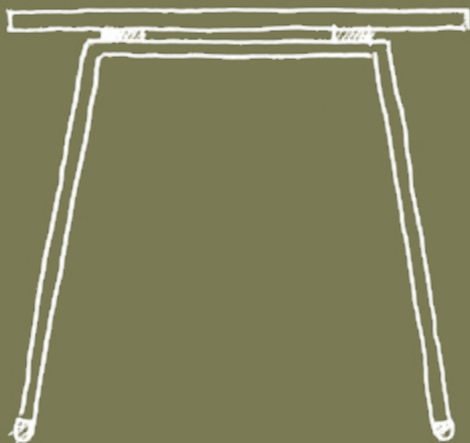

Forme e colori

che donano all'ambiente di lavoro un senso di freschezza e creatività



Atreo collection with its versatile shapes and colours, delivers freshness and creativity to your work environment.

La collection Atreo avec ses formes et couleurs donne un sentiment de créativité à l'environnement.



La colección Atreo, con sus distintas formas y colores, nos entrega frescura y creatividad al medio ambiente.



/versatilità

Atreo è un sistema molto versatile che offre soluzioni ideali per le postazioni di lavoro singole o multiple. I contenitori laterali strutturali possono essere dotati di cuscino. Le gambe hanno varie forme, aperte o ad anello.

| versatility Atreo is a versatile system that offers ideal solutions for single or multiple workstations. Structural side storage units can be equipped with a cushion. Legs are available in various shapes, open or loop legs.



| versatilité Atreo est un système très polyvalent qui offre des solutions idéales pour un ou plusieurs postes de travail. Les conteneurs latéraux structurels peuvent être équipés d'un coussin. Les pieds ont des formes variées, ouvertes ou en anneau.

| versatilidad Atreo es un sistema muy versátil que ofrece soluciones ideales para estaciones de trabajo individuales o múltiples. Los contenedores laterales estructurales se pueden equipar con un cojín. Las patas tienen varias formas, abiertas o en anillo.



/funzionalità

I bench con contenitori strutturali laterali sono una soluzione molto funzionale. Infatti, consentono di compattare lo spazio di archiviazione in prossimità della postazione di lavoro, mentre il transito dei cavi avviene all'interno del vano tecnico (schiena removibile).



functionality benches with lateral structural storage units are an excellent functional solution. In fact, they allow to compact the storage space, keeping it close to the workstation. Structural units are equipped with a false back to allow cable management.



fonctionnalité les bench avec des conteneurs structuraux latéraux sont une solution très fonctionnelle. En effet, ils permettent de compacter l'espace de stockage à proximité du poste de travail, tandis que le passage des câbles s'effectue à l'intérieur du compartiment technique (dos amovible).



funcionalidad los bench con contenedores estructurales laterales son una solución muy funcional. De hecho, permiten compactar el espacio de almacenamiento cerca de la estación de trabajo, mientras que el tránsito de los cables se realiza dentro del compartimiento técnico (parte posterior extraíble).







/tutto a portata di mano

I contenitori strutturali sono perfetti per diverse soluzioni dal grande impatto estetico. Si possono accessorizzare con cuscini rivestiti in tessuto che conferiscono una nuova funzione di seduta.

Everything at your fingertips structural storage units are perfect for a variety of aesthetically pleasing solutions. They can be accessorized with cushions upholstered in fabric that give them a new function.

Tout à portée de main les meubles de service sont parfaits pour les différents solutions d'un grand impact esthétique. Ils peuvent être accessorisés avec coussins en tissu qui donnent une nouvelle fonction d'assise.

Todo a mano los contenedores estructurales son perfectos para diferentes soluciones de gran impacto estético. Se pueden equipar con cojines revestidos en tela que confieren una nueva función.







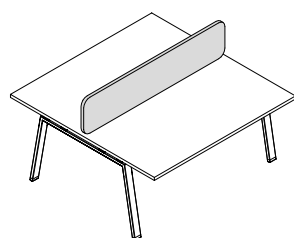
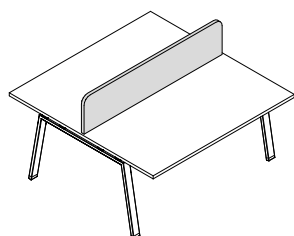
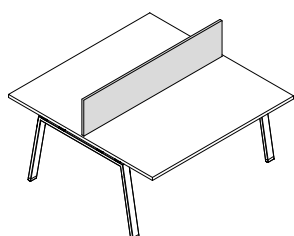

/screen

I bench con piano unico di ampie dimensioni sono pensati per essere accessoriati con screen soprapiano. Questi ultimi possono occupare tutta la larghezza del piano oppure essere rientranti. Gli angoli possono essere raggiati in base alle scelte estetiche.

I screens large single bench tops are designed to be accessorized with screens above the worktop. They can fulfil the entire width or be recessed. Corners can be rounded, depending on the aesthetic choices.

I paneles de separación los bench con sobre de una sola pieza de gran tamaño están diseñados para ser equipados con paneles de separación colocados arriba del sobre mismo. Los paneles de separación pueden ocupar todo el ancho disponible o quedarse remetidos. Las esquinas pueden ser redondeadas de acuerdo con las elecciones estéticas.

I écrans de séparation les bench avec un plateau d'un seul tenant sont conçus pour être accessorisés avec des écrans de séparation qui se fixent directement au-dessus du plateau. Ils peuvent recouvrir toute la longueur du plateau ou être rentrants. Les coins peuvent être arrondis selon choix esthétique.





Ai bench con piani separati ed alle scrivanie singole, si possono agganciare screen rettangolari o trapezoidali oltre alla particolare forma "a onda".

Rectangular or trapezoidal screens (as well as the special "wave" shape) can be hung to benches with separate tops or to single desks.

Aux bench avec plateaux séparés et aux bureaux individuels, on peut accrocher des écrans de séparation rectangulaires ou trapézoïdaux en ajoute à la particulière forme en "vague".

Los bench con sobres sueltos y las mesas, se pueden equipar con paneles de separación rectangulares o trapezoidales, además de la particular forma "onda".









/regolazione

Le gambe Atreo sono disponibili in diversi colori epossidici e possono essere posizionate a filo con il piano oppure rientranti. Tutte le versioni di gamba presentano anche una soluzione regolabile in altezza cm 65-85 (altezza sopra-piano).

Adjustment Atreo legs come in several epoxy paint finishes and can be flush with the top or recessed. All leg options feature a 65-85 cm height-adjustable version (25 9/16"-33 7/16") (height above the top).

Réglage les pieds Atreo sont disponibles dans différentes couleurs époxy et peuvent être placées à ras du plan de travail ou en retrait. Toutes les versions de jambe disposent également d'une solution réglable en hauteur de 65 à 85 cm (hauteur au-dessus du plateau).

Ajuste las patas de Atreo están disponibles en diferentes colores epoxi y se pueden quedar alineadas con el sobre o remetidas. Todas las versiones de patas tienen también una solución ajustable en altura cm 65-85 (altura sobre el tablero).









/convenience To support Atreo rectangular benches and manage electrification down to the floor, central melamine bases can be used. It is possible to choose between the 43x37 cm version with removable panel (A) and the "slim" 30x30 cm version with hinged door (B).

/commodité afin de supporter les bench rectangulaire Atreo et gérer l'électrification jusqu'au sol, il y a la possibilité d'utiliser des bases centrales en mélaminé. La choix tombe sur la version 43x37 cm avec panneaux amovible (A) et sur la version "slim" 30x30 cm avec porte battente (B).

/praticità

Per supportare i bench rettangolari Atreo e gestire l'elettrificazione fino a terra, si possono utilizzare i basamenti centrali in melaminico. È possibile scegliere tra la versione 43x37 cm con pannello asportabile (A) e la versione "slim" 30x30 cm con anta battente (B).

/practicidad para soportar los bench rectangulares Atreo y para gestionar la electrificación hasta el suelo, se pueden utilizar las bases centrales de melamina. Es posible elegir entre la versión de 43x37 cm con panel removible (A) y la versión "slim" de 30x30 cm con puerta batiente (B).

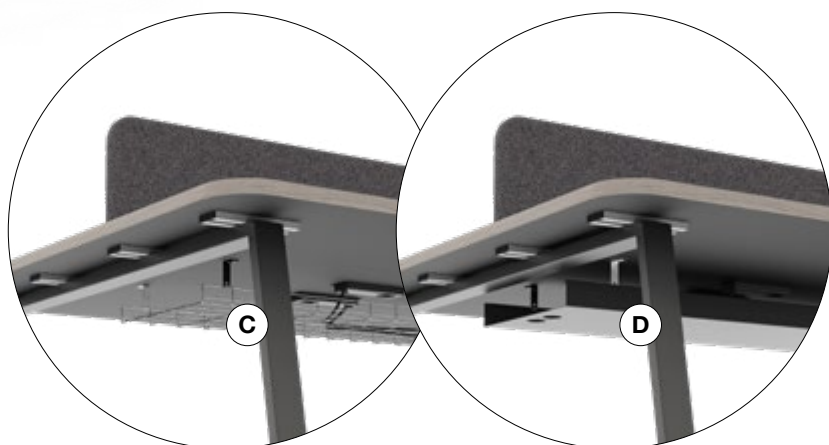

I cavi sotto il piano di lavoro vengono raccolti da cestelli (C) o canale in metallo verniciato epossidico (D).

Cables under the worktop are collected by baskets (C) or epoxy painted metal trays (D).

Les câbles au-dessous du plateau sont rassemblés dans paniers passe-câbles en fil d'acier (C) ou oulotte en métal vernie époxy (D).

Los cables bajo la superficie de trabajo son recogidos en cestas en rejilla de acero (C) o vigas en metal pintado epoxy (D).





/condivisione

Le postazioni allineate ed i bench sfruttano la possibilità delle gambe Atreo di essere condivise, riducendo al minimo i componenti strutturali. Le gambe centrali possono essere a filo con il piano oppure rientranti.





***Sharing** in line workstations and benches take advantage of the possibility of Atreo legs being shared, reducing structural components. The central legs can be either flush with the top or recessed.*

***Partage** les postes de travail côte-à-côte et les bench ont la possibilité de partager les pieds Atreo, en réduisant au minimum les composants structurels. Les pieds intermédiaires peuvent être alignés ou rentrants par rapport au plateau.*

***Compartición** las estaciones de trabajo alineadas y los bench aprovechan de la posibilidad de las patas Atreo de ser compartidas, reduciendo al mínimo los componentes estructurales. Las patas centrales se pueden quedar alineadas con el sobre o remetidas.*







/accostamenti

Tra le soluzioni piu attuali di archiviazione troviamo Lato, la collezione di armadietti modulari con scocca in melaminico. Le ante possono essere in melaminico o metallo, mentre le schiene in melaminico possono essere rivestite in tessuto. Le molte opzioni di materiali e colori, rendono Lato il complemento ideale per le scrivanie Atreo.

***Combinations** our most trendy storage solutions include Lato, the modular locker system with melamine shell. Doors are available in melamine or metal, whilst melamine back panels can be upholstered in fabric. The various materials and finish options make Lato an ideal complement to Atreo desks.*

!combinaisons parmi les solutions de stockage les plus récentes, nous trouvons Lato, la collection d'armoires modulaires avec coque en mélamine. Les portes peuvent être en mélamine ou en métal, tandis que le dos en mélamine peut être recouvert de tissu. Les nombreuses options de matériaux et de couleurs font du Lato le complément idéal des bureaux Atreo.

!combinaciones entre las soluciones de almacenamiento más actuales, encontramos Lato, la colección de gabinetes modulares con carcasa de melamina. Las puertas pueden ser de melamina o metal, mientras que las traseras de melamina pueden cubrirse con tela. Las numerosas opciones de materiales y colores hacen de Lato el complemento ideal para los escritorios Atreo.









/estetica

Le gambe ad anello sono una scelta estetica semplice ed elegante che si addice sia a soluzioni bench che alle scrivanie singole. Tutte le tipologie di gambe sono dotate di piedini ergonomici e viti di livellamento millimetriche in polipropilene traslucido nero o bianco.



!aesthetics ring legs are a simple and elegant aesthetic choice that suits both bench solutions and individual desks. All leg types are equipped with ergonomic feet and millimetric levelling screws in translucent black or white polypropylene.

!esthétique les pieds fermés sont une choix esthétique simple et élégant disponibles soit pour solutions bench soit pour bureaux individuels. Toutes typologies de pieds sont équipé de vérin érgonomiques et vis de nivelage en polypropylène translucide noir ou blanc.

!estética las patas de anillo son una opción estética simple y elegante que se adapta tanto a estaciones de trabajo así como a mesas individuales. Todos los modelos de patas están equipados de pies ergonómicos y tornillos de nivelación milimétricos en polipropileno blanco o negro translúcido.











/postazioni multiple

Le postazioni a 120° sono ideali per compattare i posti lavoro in modo creativo e funzionale. Anche per questi gruppi da tre, il basamento triangolare centrale è dotato di sportello per accesso al cablaggio.



I clusters 120° compositions are ideal for compacting workplaces in a creative and functional way. For three-workstation clusters, the central triangular base features a door for wiring access.



I postes de travail multiples les postes de travail à 120° sont idéaux pour le compactage des lieux de travail de manière créative et fonctionnelle. Pour ces groupes de trois, la base triangulaire centrale est équipée d'une porte permettant d'accéder au câblage.

I estaciones múltiples de trabajo las estaciones 120° son ideales para compactar puestos de trabajo de una manera creativa y funcional. También para estos grupos de tres, la base triangular central está equipada con una puerta para acceder al cableado.













/linee curve

Atreo, in quanto sistema ultra flessibile, permette anche di realizzare tavoli riunione curvi, particolarmente apprezzati per l'arredo di sale polifunzionali, biblioteche ed ambiti scolastici.



***/curves** as an ultra-flexible system, Atreo also makes it possible to create curved tables, which are particularly popular for furnishing multi-purpose rooms, libraries and schools.*

***/lignes courbes** Atreo, en tant que système très flexible, permet de réaliser de tables de réunion incurvées, bien appréciées pour l'aménagement de salles multifonctionnelles, bibliothèques et milieux scolaires.*

***/líneas curvas** Atreo, como es un sistema ultra flexible, permite realizar también mesas de reuniones curvas, particularmente apreciadas por el equipamiento de salas multifuncionales, bibliotecas y escuelas.*







/direzionali

La straordinaria flessibilità della collezione Atreo permette di soddisfare anche le esigenze di un ufficio privato. La scrivania può infatti essere interpretata per soluzioni direzionali, moderne ed eleganti.

! executive the extraordinary flexibility of the Atreo collection means that it can also meet the need of private offices. Desks can be interpreted for executive, modern and elegant solutions.



***l'exécutif** l'extraordinaire flexibilité de la collection Atreo, permet de satisfaire également les exigences d'un bureau privé. Le bureau peut être conçu pour solutions exécutives, modernes et élégantes.*

***l despachos ejecutivos** la extraordinaria flexibilidad de la colección Atreo permite satisfacer también las necesidades de un despacho privado. La mesa, de hecho, puede ser interpretada para soluciones ejecutivas, modernas y elegantes.*



/accessori

Offriamo molteplici soluzioni per accessoriare i piani di scrivanie, bench e tavoli. L'elettificazione può essere gestita in modo semplice e pratico grazie ai moduli Flat, che permettono di integrare direttamente al piano un sistema di prese personalizzabile. La cornice in metallo verniciato si abbina perfettamente al colore della struttura, enfatizzando un design che pensa ad ogni minimo dettaglio.

***/accessories** we offer a wide range of solutions to equip desks, benches and tables. Electrification can be managed in a simple and practical way thanks to Flat modules, which allow a customisable socket system to be integrated directly into the top. The painted metal frame perfectly matches the colour of the structure, emphasising a design that pays attention to every detail.*

***Les accessoires** beaucoup de solutions sont offertes afin de pouvoir accessoriser les plateaux de bureaux, bench et tables de réunion. L'électrification peut être gérée très simplement grâce à nos modules Flat, qui permettent d'incorporer le système de prises directement sur le plateau. Le cadre en métal époxy est parfaitement coordonné à la couleur de la structure, en mettant en valeur un design qui pense à chaque petit détail.*

***Los accesorios** ofrecemos muchas soluciones para electrificar los sobres de mesas, estaciones de trabajo y mesas de juntas. La electrificación se puede manejar de manera simple y práctica gracias a los módulos Flat, que permiten integrar directamente en el sobre un sistema de tomas personalizables. El marco de metal pintado se combina perfectamente con el color de la estructura, enfatizando un diseño que piensa en cada mínimo detalle.*





/riunioni

I tavoli riunione Atreo possono essere singoli o multipli. In entrambi i casi vengono proposti sia con gamba a cavalletto che con gamba a ponte. Le linee essenziali permettono di giocare sugli abbinamenti tra piano e gamba per rendere l'arredo unico ed accogliente.

***/meetings** Atreo meeting tables can be single or multiple. In both cases they are available with either A-shape or straight legs. The essential lines allow you to play with top and leg combinations to make furniture unique and welcoming.*



l***r******é******u******n******i******o******n*** *les tables de réunion*
Atreo peuvent être individuelles
ou multiples. Dans les deux cas,
elles sont proposées avec pieds
trapèze ainsi que pieds droits.
Les lignes essentielles permettent
de jouer sur les compléments
entre plateau et pied, afin de
créer l'aménagement unique et
accueillant.

l***r******e******u******n******i******o******n******e******s*** *las mesas de reunión*
Atreo pueden ser individuales
o múltiples. En ambos casos
se proponen tanto con pata de
caballete como con pata recta.
Las líneas esenciales permiten
jugar en las combinaciones
entre sobre y pata para hacer el
mobiliario único y acogedor.











/media console

Le console Atreo sono disponibili sia nella versione mobile che fissa e offrono spazio per agganciare i monitor. I cavi sono raccolti all'interno del pannello verticale e fuoriescono da un apposito accesso.

I media consoles Atreo consoles are available in both mobile and fixed versions and offer space to hung monitors. Cables are collected inside the vertical panel and exit through a special access.

I cloisons techniques Les cloisons techniques Atreo peuvent être fixés au mur ou avoir des roulettes afin de pouvoir être déplacés. Ils offrent également un espace pour accrocher un moniteur. Les câbles sont cachés dans le cloison vertical et ils sortent par un accès approprié.

I media console las consolas Atreo son disponibles tanto en la versión móvil que fija y ofrecen espacio para colocar los monitores. Los cables se recogen en el interior del panel vertical y salen de un especial acceso.



Piani | desk tops | plateaux | sobros

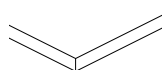

con angoli dritti, in melaminico
with straight corners, Italian melamine
avec coins droits, en mélaminé
con esquinas rectas, en melaminico



con angoli raggati, in melaminico
with rounded corners, Italian melamine
avec coins arrondis, en mélaminé
con esquinas redondeadas, en melaminico

gli screen sono possono essere sia fissi che mobili, disponibili nelle finiture: melaminico, goffrato, metacrilato, tessuto, OSB
screens can be fixed or mobile, available in the following finishes: Italian melamine, embossed, acrylic, fabric, OSB
les écrans peuvent être fixes ou mobiles, disponibles dans les finitions: mélaminé, gaufré, méthacrylate, tissu, OSB
los paneles pueden ser fijos o móviles, disponibles en los siguientes acabados: melaminico, lacado, metacrilato, tejido, OSB

Gambe | legs | pieds | patas

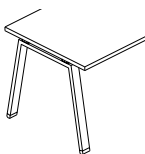

a cavalletto, in metallo anche con inserto legno
A-shape, metal epoxy painted, also with solid wood insert
tréteau, métal peint époxy, aussi avec insert en bois
caballete, metal pintado epoxi, también con inserto de madera

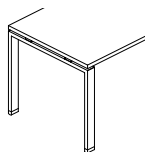

a ponte, metallo verniciato epossidico
straight, metal epoxy painted
droit, métal peint époxy
recta, metal pintado epoxi

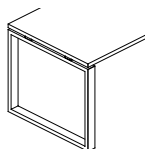

ad anello, metallo verniciato epossidico
closed loop, metal epoxy painted
en anneau, métal peint époxy
anillo, metal pintado epoxi

Scrivanie | desks | bureaux | mesas

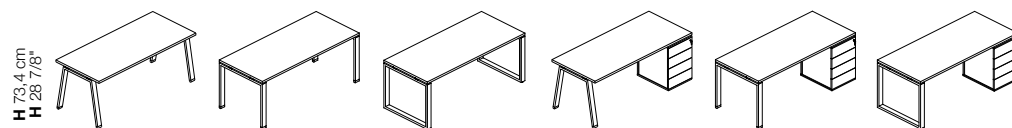

H 73,4 cm
H 28 7/8"

L 120/140/160/180/200 - P 80/90 cm
W 47 1/4"/55 1/8"/63"/70 7/8"/78 3/4" - D 31 1/2"/35 3/8"

Dattilo | returns | retours | alas

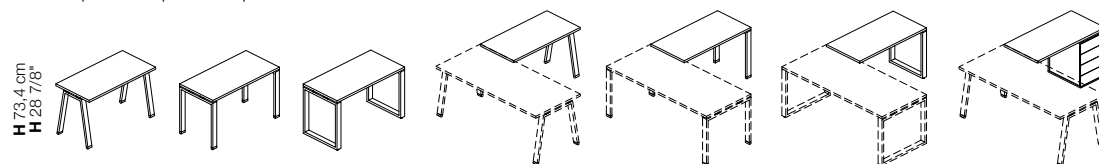

H 73,4 cm
H 28 7/8"

L 80/100/120 - P 60 cm
W 31 1/2"/39 3/8"/47 1/4" - D 23 5/8"

Tavoli riunione | meeting tables | tables de réunion | mesas de juntas

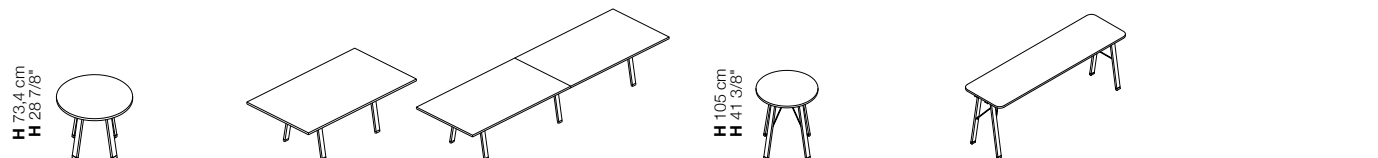

H 73,4 cm
H 28 7/8"

H 105 cm
H 41 3/8"

Ø 90/100/120/130/150 cm
Ø 35 3/8"/39 3/8"/47 1/4"/51 1/8"/59"
L 210/280 - P 120 cm
W 82 5/8"/110 1/4" - D 47 1/4"
L 420/560 - P 120 cm
W 165 3/8"/220 1/2" - D 47 1/4"
Ø 90/100/120/130/150 cm
Ø 35 3/8"/39 3/8"/47 1/4"/51 1/8"/59"
L 140/160/180/200/220/240/260/280 - P 60/80 cm
W 55 1/8"/63"/70 7/8"/78 3/4"/86 5/8"/94 1/2"/102 3/8"/110 1/4" - D 23 5/8"/31 1/2"

Tavolini da caffè | coffee tables | tables basses | mesitas

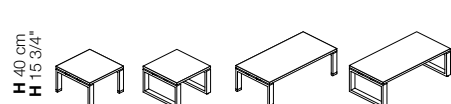

H 40 cm
H 15 3/4"

L/P 60 cm
W/D 23 5/8"
L 120 - P 60 cm
W 47 1/4" - D 23 5/8"

Mobili di servizio | service units | meuble retour | muebles de servicio

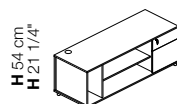

H 54 cm
H 21 1/4"

L 160 - P 58 cm
W 63" - D 22 7/8"

Esempi composizioni | composition example | exemples de compositions | ejemplos de composiciones

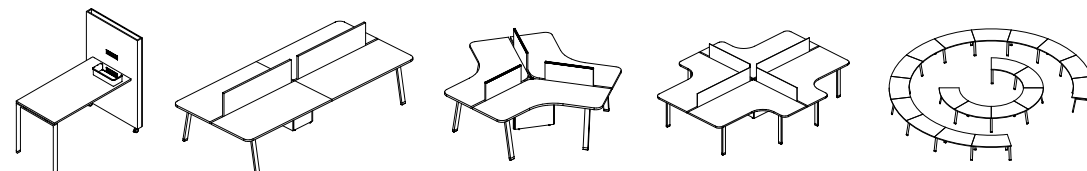

Finiture | Finishes | Finitions | Acabados

MEL

Melaminico

Melamine | Mélaminé | Melaminico

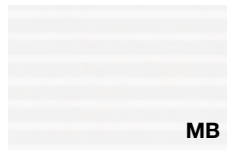
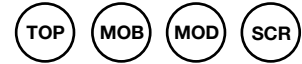

MB

Bianco rigato
Rippled effect white
Blanc avec rayures en sérigraphie
Blanco rayado

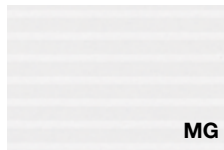

MG

Grigio rigato
Rippled effect grey
Gris avec rayures en sérigraphie
Gris rayado



MF

Nichel
Nickel
Nickel
Níquel



MZ

Cacao
Cocoa
Cacao
Cacao



MN

Bianco
White
Blanc
Blanco

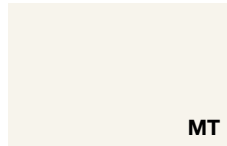

MT

Talco
Talc
Talco
Talco



MJ

Ocra
Ochre
Ocre
Ocre



MH

Terracotta
Terracotta
Terre cuite
Terracota



MK

Safari
Safari
Safari
Safari



MI

Noisette
Noisette
Noisette
Noisette



MV

Verde
Green
Vert
Verde



ML

Nero
Black
Noir
Negro



MQ

Blu notte
Night blue
Bleu nuit
Azul noche

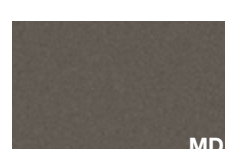

MD

Ardesia
Ardesia
Ardesia
Pizarra

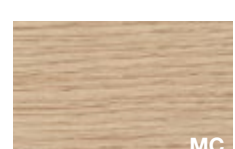

MC

Rovere chiaro
Light oak
Chêne clair
Roble claro

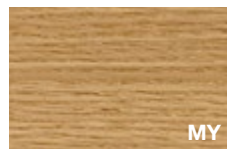

MY

Rovere americano
American oak
Chêne américain
Roble americano



ME

Rovere grigio
Grey oak
Chêne gris
Roble gris

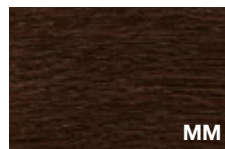

MM

Rovere moro
Dark oak
Chêne foncé
Roble oscuro

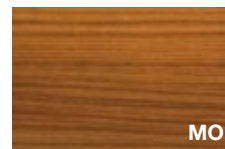

MO

Noce Canaletto
Canaletto Walnut
Noyer Canaletto
Nogal Canaletto



MW

Noce scuro
Dark walnut
Noyer foncé
Nogal oscuro

OSB

OSB

OSB | OSB | OSB



OSB

OSB
OSB
OSB
OSB

Le finiture contenute nel presente catalogo sono puramente indicative e non sono di riferimento per le finiture del prodotto Due to the printing process, finishes shown in this catalogue are for illustration only. The finish on the final item may differ slightly from the printed illustration
Les finitions contenues dans ce catalogue ne sont pas contractuelles - les photos ne pouvant rendre la parfaite réalité
Los acabados contenidos en este catálogo son puramente indicativos y no son de referencia para los suministros del producto



TES

Tessuto

Fabric | Tissu | Tejido



Beige
Beige
Beige
Beige



Grigio chiaro
Light grey
Gris clair
Gris claro



Ardesia
Ardesia
Ardesia
Pizarra



Blu avio
Avio blue
Bleu avio
Azul avio



Acquamarina
Aquamarine
Aigue-marine
Aguamarina



Verde primavera
Spring green
Vert printemps
Verde primavera



Salvia
Sage
Sauge
Salvia

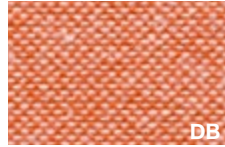

Arancio
Orange
Orange
Naranja

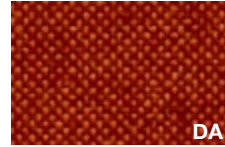

Corallo
Coral
Corail
Coral

GOF

Goffrato

Embossed | Gaufré | Gofrado



Bianco
White
Blanc
Bianco

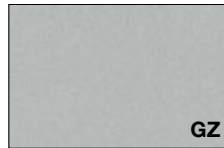

Argento
Silver
Argent
Plata



Grigio scuro
Dark grey
Gris foncé
Gris oscuro



Noisette
Noisette
Noisette
Noisette

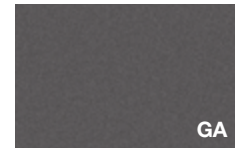

Ardesia
Ardesia
Ardesia
Pizarra



Moka
Mocha
Moka
Cafe

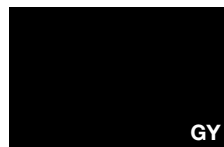

Nero
Black
Noir
Negro



Arancione
Orange
Orange
Naranja



Rosso "F"
Red "F"
Rouge "F"
Rojo "F"



Rubino
Ruby
Rubis
Rubí



Indaco
Indigo
Indigo
Azul Indigo



Azzurro
Blue
Bleu
Azul



Verde
Green
Vert
Verde



Cedro
Lime green
Vert Cédrat
Verde Cedro

MTC

Metacrilato

Acrylic | Méthacrylate | Metacrilato

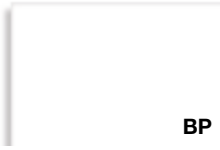

BP

Bianco opalino

Opaline white
Blanc opalin
Blanco opaco



TR

Trasparente

Transparent
Transparent
Transparente



RS

Rosso trasparente

Red transparent
Rouge transparent
Rojo transparente



BL

Blu trasparente

Blue transparent
Bleu transparent
Azul transparente



BN

Bianco satinato

Satin-finish white
Blanc satiné
Blanco satinado



FU

Grigio fumè satinato

Satin-finish smoky grey
Gris satiné
Gris satinado



AR

Arancione satinato

Satin-finish orange
Orange satiné
Naranja satinado



BT

Blu satinato

Satin-finish blue
Bleu satiné
Azul satinado



VV

Verde satinato

Satin-finish green
Vert satiné
Verde satinado

EPX

Epossidico

Epoxy | Époxy | Epoxi



EB

Bianco

White
Blanc
Blanco

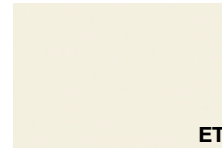

ET

Talco

Talco
Talco
Talco



EG

Grigio

Grey
Gris
Gris



YD

Beige Arizona

Arizona beige
Beige Arizona
Beige Arizona



EO

Noisette

Noisette
Noisette
Noisette



EK

Safari

Safari
Safari
Safari



EE

Rame

Copper
Cuivre
Cobre



EH

Terracotta

Terracotta
Terre cuite
Terracota

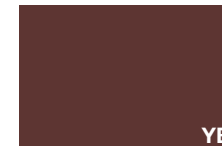

YB

Rosso Jaipur

Jaipur red
Rouge Jaipur
Rojo Jaipur

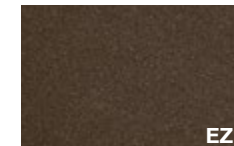

EZ

Bronzo

Bronze
Bronze
Bronce



YQ

Blu notte

Night blue
Bleu nuit
Azul noche



YC

Grigio Bromo

Bromo grey
Gris Bromo
Gris Bromo

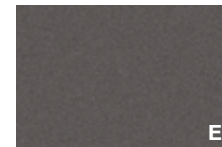

EI

Ardesia

Ardesia
Ardesia
Pizarra



YV

Verde Comodoro

Comodoro green
Vert Comodoro
Verde Comodoro



EN

Nero

Black
Noir
Negro

Applicazioni finiture

Finish application | Application finitions | Aplicacion acabados



TOP
Top
Piano
Plateau
Sobre



SCR
Screen
Screen
Ecran
Panel



MOD
Modesty panel
Modesty panel
Voile de fond
Faldón



MOB
Mobile di servizio
Service unit
Meuble de service
Mueble de servicio



STRU
Struttura
Structure
Structure
Structura

Le finiture contenute nella stampa sono puramente indicative e non sono di riferimento per le forniture del prodotto

Due to the printing process, finishes shown in this document are for illustration only. The finish on the final item may differ slightly from the printed illustration

Les finitions contenues dans l'impression sont purement indicatives et ne sont pas pertinentes pour les fournitures du produit

Los acabados contenidos en la impresión son puramente indicativos y no son de referencia para los suministros del producto

Ambiente e sicurezza | Environment and safety | Environnement et sécurité | Medio ambiente y seguridad

Ecologia: Alea utilizza per i suoi prodotti e i suoi imballi materiali facilmente separabili e riciclabili. (Immagine 1)

Catena Di Custodia COC: Alea si impegna ad utilizzare materiali legnosi certificati FSC® e pannelli a base di legno con certificazione CARB2.

I pannelli CARB2 presentano un rilascio di formaldeide inferiore rispetto al pannello E1 comunemente utilizzato (classe E1 secondo il DM 10/10/2008).

I prodotti certificati FSC ® (License Code FSC-C118323) sono disponibili su richiesta: contattate i nostri uffici per maggiori informazioni. (Immagine 2)

LEED: Gli arredi di Alea possono contribuire al conseguimento del punteggio di certificazione LEED per i crediti indicati nei product badge. (Immagine 3)

Sistemi di Gestione certificati ISO 9001, ISO 14001, ISO 45001: Alea è attivamente impegnata nel raggiungere standard elevati di qualità e responsabilità attraverso l'adozione di sistemi di gestione certificati ISO per garantire prodotti e servizi di elevata qualità, in grado di soddisfare le aspettative dei clienti, di assicurare un ambiente di lavoro sicuro e di monitorare regolarmente l'impatto ambientale delle nostre attività. (Immagine 4)

Attestazione di prodotto: I prodotti Alea sono stati sottoposti a prove prestazionali presso laboratori di prova accreditati.

Copia dei rapporti di prova o delle attestazioni di conformità sono disponibili su richiesta. (Immagine 5)

Eco-friendly: Alea uses easily separable and recyclable materials for its products and packaging. (Image 1)

Chain of Custody (COC): Alea is committed to using FSC® certified wood materials and CARB2-certified wood-based panels. CARB2 panels have lower formaldehyde emissions compared to the commonly used E1 panels (class E1 according to the DM 10/10/2008). FSC® certified products (License Code FSC-C118323) are available upon request: please contact our offices for more information. (Image 2)

LEED: The A65 system can contribute to obtaining LEED certification points for the credits indicated in the product badges. (Image 3)

ISO 9001, ISO 14001, ISO 45001 Certified Management Systems: Alea is actively committed to achieving high standards of quality and responsibility through the adoption of ISO certified management systems to ensure high-quality products and services that meet customer expectations, provide a safe working environment, and regularly monitor the environmental impact of our activities. (Image 4)

Product Certification: Alea products have undergone performance tests by accredited testing laboratories. Copies of test reports or certificates of conformity are available upon request. (Image 5)



Immagine 1



Immagine 2



Immagine 3



Immagine 4



Immagine 5

Ambiente e sicurezza | Environment and safety | Environnement et sécurité | Medio ambiente y seguridad

Écologie: Alea utilise pour ses produits et ses emballages des matériaux facilement séparables et recyclables. (Image 1)

Chaîne de contrôle COC: Alea a à cœur d'utiliser des matériaux en bois certifiés FSC® et des panneaux à base de bois avec la certification CARB2.

Les panneaux CARB2 présentent une émission de formaldéhyde inférieure à celle des panneaux E1 couramment utilisés (classe E1 selon le DM 10/10/2008). Les produits certifiés FSC® (Code de licence FSC-C118323) sont disponibles sur demande : veuillez contacter nos bureaux pour plus d'informations. (Image 2)

LEED: Le système A65 peut contribuer à l'obtention des points de certification LEED pour les crédits indiqués dans les badges produits. (Image 3)

Systèmes de gestion certifiés ISO 9001, ISO 14001, ISO 45001: Alea s'engage activement à atteindre des normes élevées de qualité et de responsabilité à travers l'adoption de systèmes de gestion certifiés ISO pour garantir des produits et services de haute qualité, répondre aux attentes des clients, assurer un environnement de travail sûr et surveiller régulièrement l'impact environnemental de nos activités. (Image 4)

Attestation de produit: Les produits Alea ont été soumis à des tests de performance dans des laboratoires d'essais accrédités. Des copies des rapports de tests ou des certificats de conformité sont disponibles sur demande. (Image 5)

Ecología: Alea utiliza para sus productos y embalajes materiales fácilmente separables y reciclables. (Imagen 1)

Cadena de Custodia COC: Alea se compromete a utilizar materiales de madera certificados por FSC® y paneles a base de madera con certificación CARB2.

Los paneles CARB2 presentan una emisión de formaldehído inferior en comparación con los paneles E1 comúnmente utilizados (clase E1 según el DM 10/10/2008). Los productos certificados por FSC® (Código de Licencia FSC-C118323) están disponibles bajo solicitud: por favor contacte a nuestras oficinas para más información. (Imagen 2)

LEED: El sistema A65 puede contribuir a la consecución de la puntuación de certificación LEED para los créditos indicados en los product badges. (Imagen 3)

Sistemas de Gestión Certificados ISO 9001, ISO 14001, ISO 45001: Alea está comprometida activamente en alcanzar altos estándares de calidad y responsabilidad mediante la adopción de sistemas de gestión certificados por ISO para garantizar productos y servicios de alta calidad, que cumplen con las expectativas de los clientes, aseguran un entorno de trabajo seguro y monitorean regularmente el impacto ambiental de nuestras actividades. (Imagen 4)

Certificación de Producto: Los productos Alea han sido sometidos a pruebas de rendimiento en laboratorios acreditados. Las copias de los informes de prueba o los certificados de conformidad están disponibles bajo solicitud. (Imagen 5)



Immagine 1



Immagine 2



Immagine 3



Immagine 4



Immagine 5

Le finiture contenute nella stampa sono puramente indicative e non sono di riferimento per le forniture del prodotto

Due to the printing process, finishes shown in this document are for illustration only. The finish on the final item may differ slightly from the printed illustration
Les finitions contenues dans l'impression sont purement indicatives et ne sont pas pertinentes pour les fournitures du produit
Los acabados contenidos en la impresión son puramente indicativos y no son de referencia para los suministros del producto

concept & graphic design

Alea marketing + communication

design

Mirto Antonel & Filippon

art direction

Mirto Antonel

AC/CACB/AD



GLOBAL HEADQUARTERS AND SHOWROOM : Via Col de Rust, 19 - 33070 Sarone (PN) - Italia : Tel ++39 0434 777 333
email: info@aleaoffice.com **PARIS SHOWROOM** : 176 Avenue Charles de Gaulle 92200, Neuilly-sur-Seine - France **NORTH AMERICAN
HEADQUARTERS** : Midtown 2, 3449 NE 1st Avenue L-32, Miami, FL 33137 - USA : Tel ++1 305 470 1200 - email: info@alea-usa.com
ALEA UK OFFICE AND SHOWROOM : 50-54 Clerkenwell Road, London EC1M 5PS - email: info@aleaoffice.com