

alea

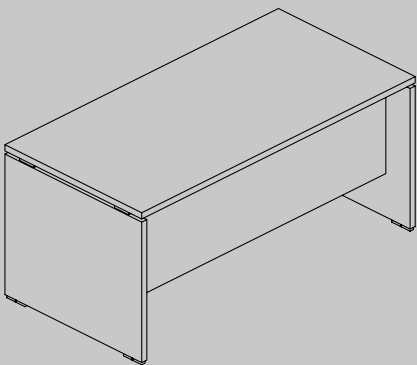

Atlante

operativi | workstations | systemes | operativos

why atlante

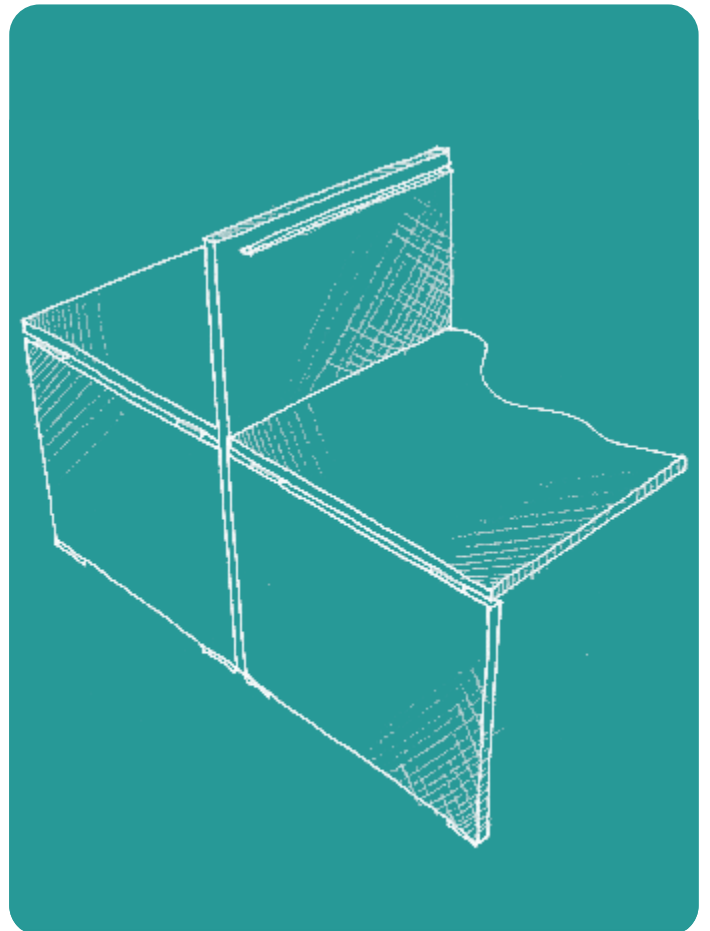
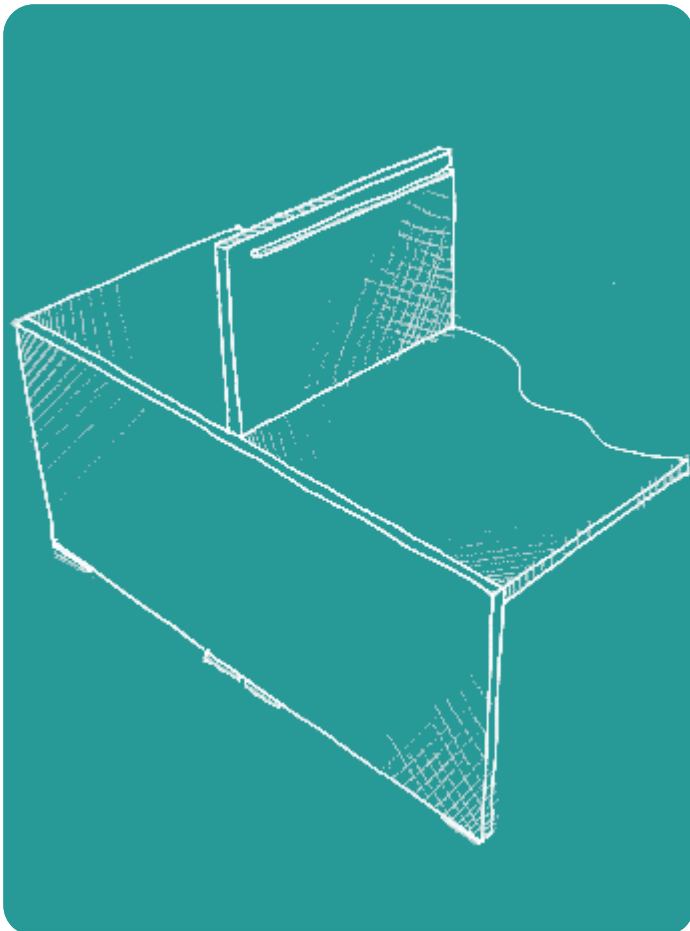

overhead

geometry

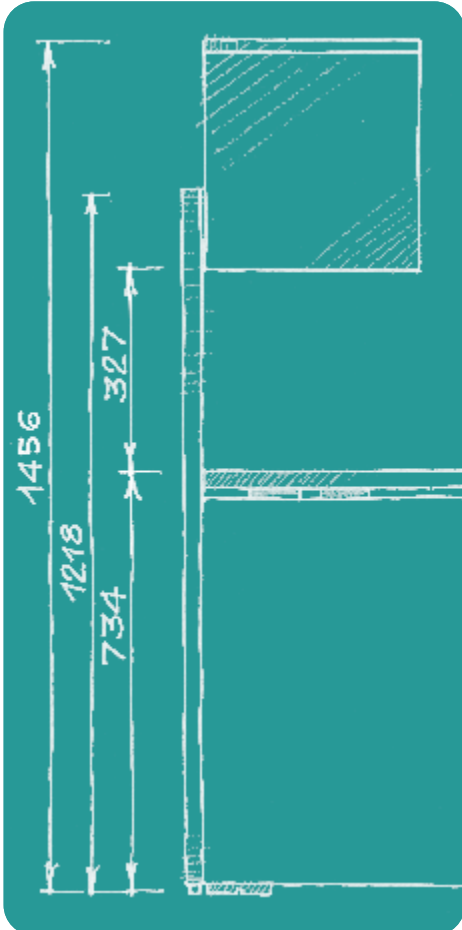

cable management

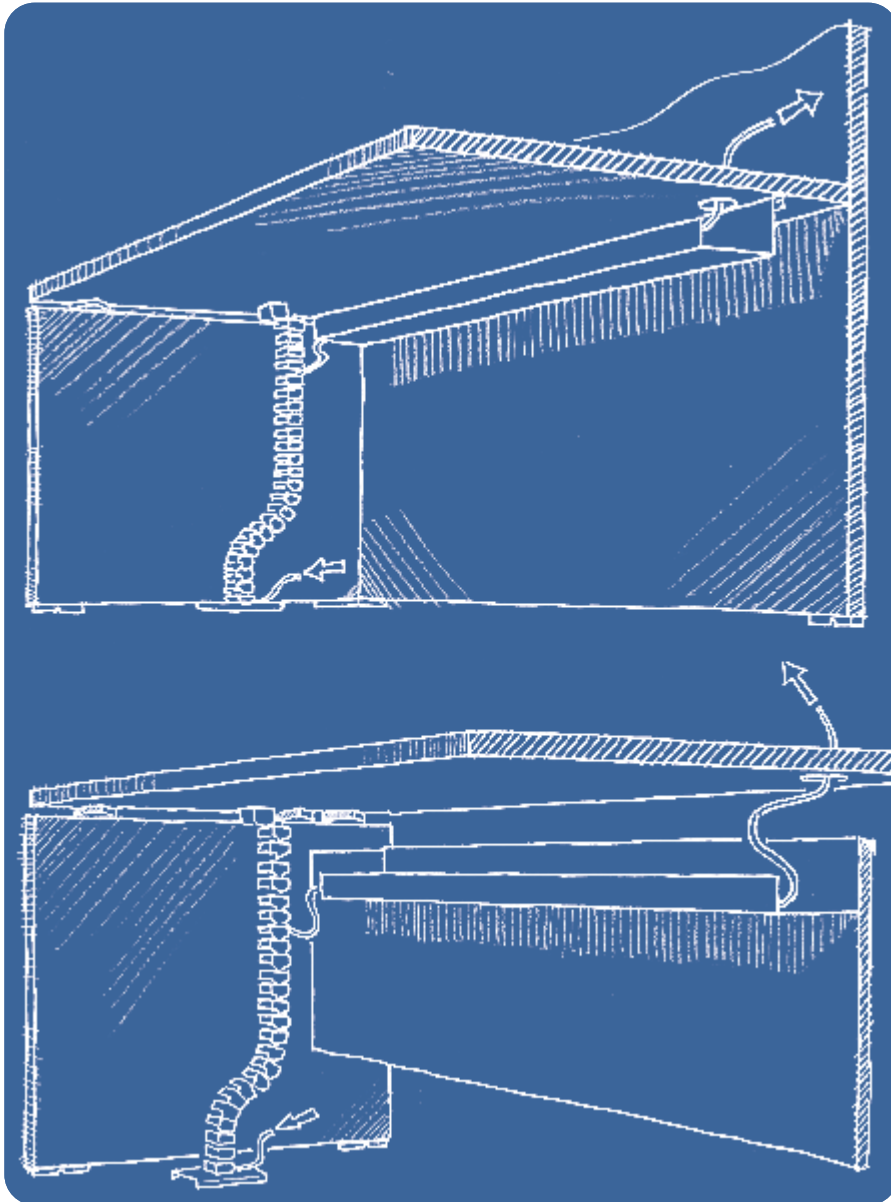

panels

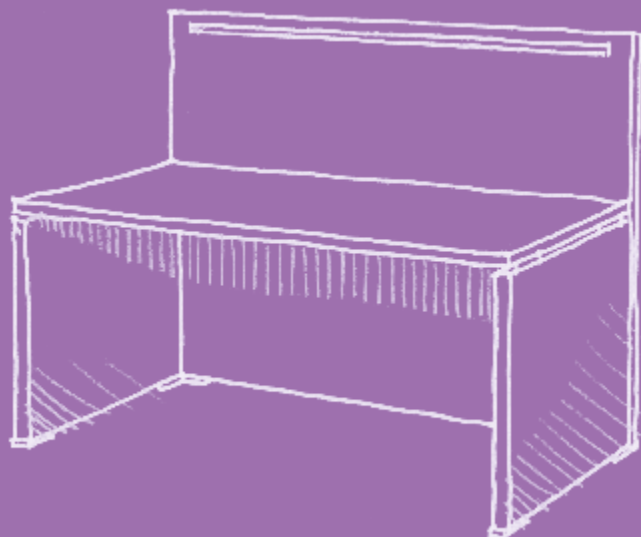

why atlante

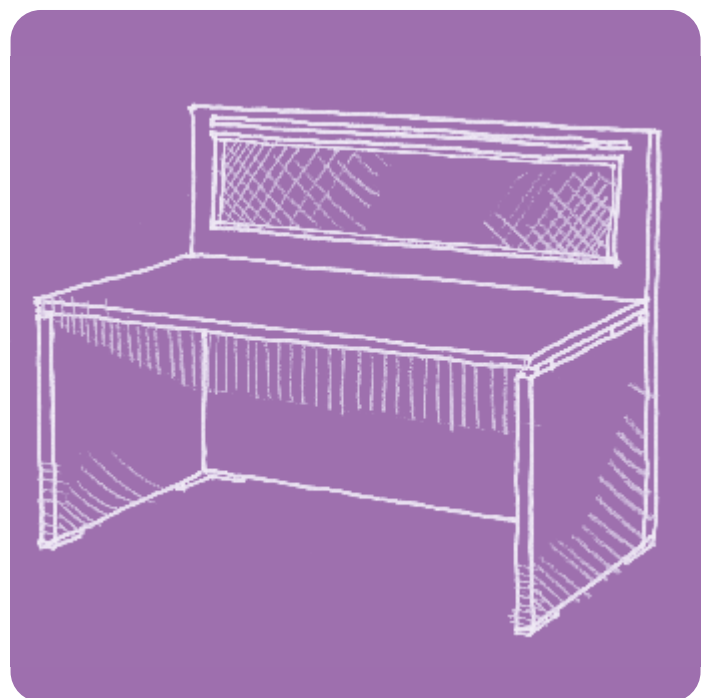
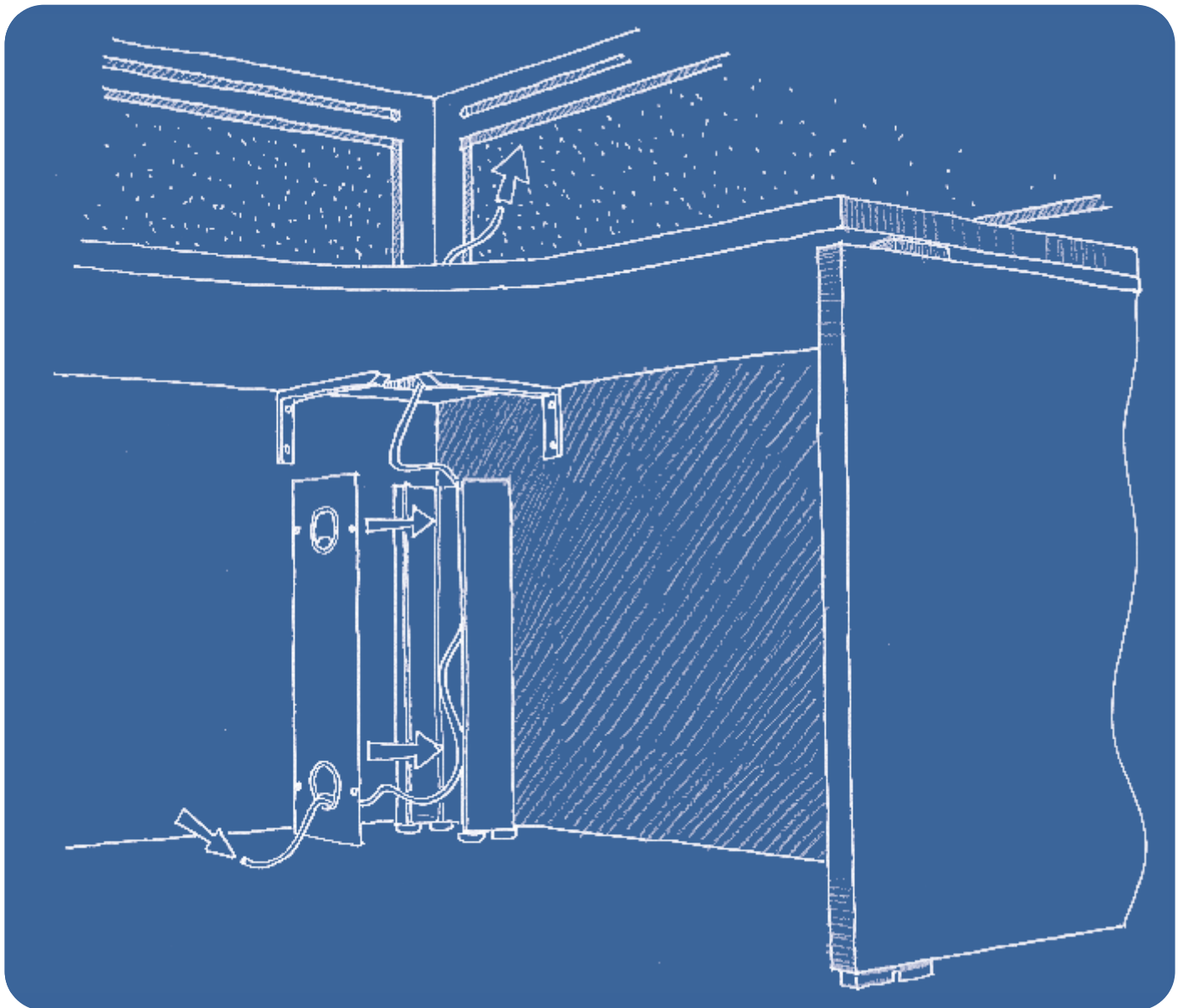





Il sistema ATLANTE, uno degli storici best seller di ALEA, viene ora riproposto con una nuova gamma di finiture e nuove soluzioni. Le pareti strutturali di altezza 120 cm, disponibili anche nella versione con finestra in tessuto puntaspilli, sono attrezzabili con corpetti contenitori ad ante scorrevoli in acrilico e melaminico.

ATLANTE system, one of the historic ALEA's best sellers, has now been proposed in a new selection of finishes and solutions. The structural panels H.120 cm (47 1/4"), available in the version with tackable fabric window, can be equipped with overhead cabinets with sliding doors in acrylic or Italian melamine.





Le programme ATLANTE, un des historiques best seller de ALEA, est maintenant proposé avec une nouvelle palette de finitions ainsi que dans des solutions plus actuelles. Les cloisons structurales de 120cm de hauteur, disponibles même dans la version avec panneau revêtu en tissu punaisable, peuvent être équipées avec rangements à portes coulissantes en acrylique ou mélaminé.

El sistema ATLANTE, uno de los históricos best-seller de ALEA, ha sido relanzado con una nueva gama de acabados y soluciones. Los paneles estructurales de alt. 120cm, disponibles en versión con ventana tapizada pinchable, pueden ser equipados con contenedores de puerta corredera en acrílico o melamina.



Alle pareti possono essere applicati screen aggiuntivi in acrilico fissati su eleganti profili in alluminio anodizzato per incrementare l'altezza e il livello di privacy dell'utilizzatore.



Additional acrylic screens can be added to the panels and fixed on elegant anodized aluminium frames to increase the height and the privacy level of the user.

Les cloisons sont équipées avec des élégants profils en aluminium anodisé pouvant recevoir des écrans supplémentaires en acrylique pour augmenter la hauteur et le niveau d'intimité de l'opérateur.

Todos los paneles pueden llevar un screen superior en acrílico, fijado mediante un elegante perfil en aluminio anodizado, para incrementar así la altura y la privacidad del usuario.









Mrs. Wilson

Wilson

Wilson

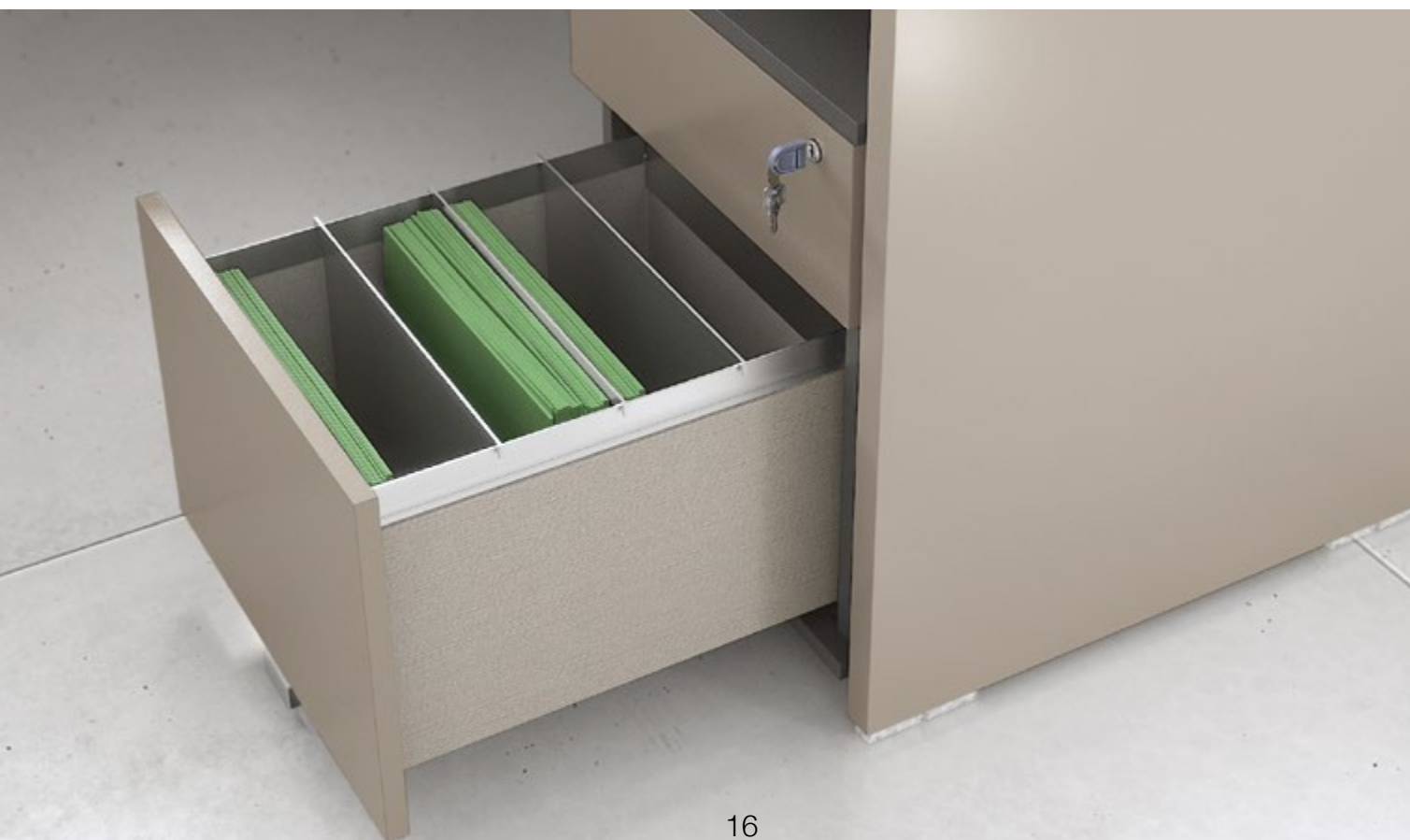



ATLANTE propone anche workstation sagomate a 90° e 120° e contenitori laterali altezza cm 120 con guide di scorrimento su cuscinetti a estrazione totale, utili per la archiviazione di documenti di frequente consultazione.

ATLANTE offers also shaped 90° and 120° workstations and side storage units H.120 cm (47 ¼") with full extension ball bearing slides, useful for a practical filing system for every day documents.

La collection ATLANTE prévoit aussi des plateaux compacts à 90° et 120° et des rangements latéraux de 120cm de hauteur avec tiroirs dotés de glissières à billes à extraction totale, très utiles pour le classement des dossiers qui demandent une fréquente consultation.

ATLANTE propone también estaciones de trabajo de 90 y 120° y contenedores laterales de alt. 120cm con una guía de extracción total sobre rodamientos, muy útil para el archivo de documentos de consulta frecuente.











Le pareti di ATLANTE sono anche disponibili nella versione con finestra in metacrilato in diversi colori, intelaiata da una cornice in alluminio anodizzato. Tutte le pareti sono dotate di profili nella parte superiore per agganciare accessori quali portapenne, portacarte e tavolette puntaspilli.



ATLANTE's structural panels are also available in the version with acrylic window in different colours, closed into an anodized aluminium frame. All the structural panels are equipped with profiles only on the upper side for hanging accessories like penholders, paper trays and tackable boards.

Les cloisons de ATLANTE sont disponibles aussi en version avec panneau en méthacrylate de différents couleurs, avec cadre en aluminium anodisé. Toutes les cloisons sont dotées de profils en partie haute pour accrochage des accessoires tels que porte plumes, porte feuilles et tableaux punaisables.

Los paneles estructurales ATLANTE están disponibles en la versión con ventana acrílica de diferentes colores, enmarcados en un perfil de aluminio anodizado. Todos los paneles estructurales están equipados con perfiles en la parte superior para colgar accesorios como portalápices, bandejas para papeles y tableros pinchables.













Offrendo molte opzioni di melaminico di serie, ATLANTE può essere facilmente personalizzato attraverso combinazioni di finiture. Ciascun elemento costruttivo (gamba, top, parete, struttura e fronte dei contenitori) può avere un colore diverso.

Offering many options of standard Italian melamine, ATLANTE can be easily customized using several finish combinations. Every element (leg, top, panel, structure and front of the storage units) can have a different colour.



Grâce à l'ample gamme d'options de mélaminé disponible à catalogue, ATLANTE peut être facilement personnalisé par la combinaison des plusieurs finitions. Chaque composant (piètement, top, cloison, structure et façade des rangements) peut avoir une couleur différente.

Al ofrecer muchos acabados de melamina standard, ATLANTE puede ser fácilmente personalizado por medio de la combinación de diferentes colores. Cada elemento constructivo (patas, encimeras, paredes, estructuras y frentes de contenedores) pueden tener un color diferente.









ATLANTE risponde anche alla richiesta di arredi manageriali in maniera sobria, essenziale ed elegante offrendo tutti gli elementi necessari come tavoli riunione e tavolini da caffè.



ATLANTE answers also to executive furniture requests. Simple, essential and elegant, it offers all the necessary elements as meeting tables and coffee tables.

ATLANTE répond aussi à la demande de mobilier de bureau manager de façon sobre, essentielle et élégante offrant tous les éléments nécessaires comme tables de réunion ainsi que tables à café.

ATLANTE también da respuesta a la demanda de muebles direccionales. Simple, esencial y elegante ofrece en su programa todos los elementos necesarios: mesas de reuniones, mesas de café.







ALEA sa rispondere efficacemente alle esigenze del committente più esigente, offrendo risposte all'avanguardia grazie ad una esperienza di oltre 40 anni di attività e alla vocazione per il costante aggiornamento dei materiali utilizzati e delle soluzioni tecniche.

ALEA knows how to respond to the requests from even the most discerning customer, offering cutting-edge solutions, by far a core strength it has to offer, thanks to 40 years experience made by constant upgrades, better materials and technical solutions.

ALEA est en mesure de répondre efficacement aux nécessités du client le plus exigeant, donnant des réponses à l'avant-garde grâce à une expérience de plus de 40 ans d'activité dans ce domaine et à sa vocation à la modernisation constante des matériaux utilisés ainsi que des solutions techniques adoptées.

ALEA sabe responder de manera eficaz a las demandas del cliente más exigente, ofreciendo soluciones de vanguardia, gracias a sus 40 años de experiencia y a la vocación por una constante actualización en la búsqueda de mejores materiales y soluciones técnicas.





ATLANTE è un sistema estremamente versatile e consente la realizzazione di configurazioni a progetto, integrando tra loro gli elementi strutturali quali gambe, top, pareti e contenitori. L'esperienza di ALEA nell'ambito dei progetti lo ha reso un prodotto facilmente adattabile alle necessità di diversi mercati internazionali.

ATLANTE is an extremely versatile system, allows fulfillment of customized configurations, integrating structural elements such as legs, tops, panels, and storage units. ALEA's experience in projects, made this product easily adaptable to the needs of international markets.



ATLANTE est un système extrêmement éclectique qui permet la réalisation de la plus grande partie de configurations demandés dans les projets, grâce à la combinaison entre eux des éléments structuraux tels que piètements, top, cloisons et rangements. L'expérience de ALEA dans la réalisation de gros projets, a rendu ce produit complet et facilement adaptable aux nécessités de différents marchés internationaux.

ATLANTE es un sistema extremadamente versátil que permite la realización de configuraciones personalizadas, integrando elementos estructurales como patas, encimeras, paneles y contenedores. La experiencia de ALEA en el ámbito de los proyectos hacen que este producto sea facilmente adaptable a las necesidades de los diferentes mercados internacionales.

Finiture | Finishes | Finitions | Acabados

MEL

Melaminico

Melamine | Mélaminé | Melaminico

TOP

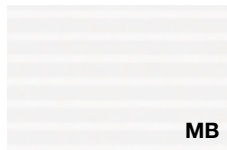

Bianco rigato
Rippled effect white
Blanc avec rayures en sérigraphie
Blanco rayado

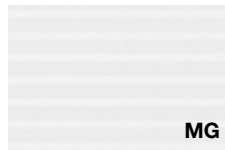

Grigio rigato
Rippled effect grey
Gris avec rayures en sérigraphie
Gris rayado



Nichel
Nickel
Nickel
Níquel



Cacao
Cocoa
Cacao
Cacao



Bianco
White
Blanc
Blanco

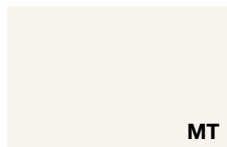

Talco
Talco
Talco
Talco



Ocra
Ochre
Ocre
Ocre



Terracotta
Terracotta
Terre cuite
Terracota



Safari
Safari
Safari
Safari



Noisette
Noisette
Noisette
Noisette



Verde
Green
Vert
Verde



Nero
Black
Noir
Negro



Blu notte
Night blue
Bleu nuit
Azul noche

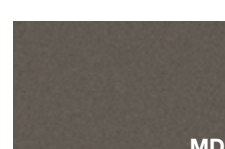

Ardesia
Ardesia
Ardesia
Pizarra

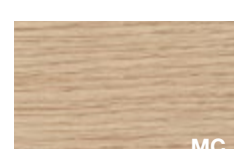

Rovere chiaro
Light oak
Chêne clair
Roble claro



Rovere americano
American oak
Chêne américain
Roble americano



Rovere grigio
Grey oak
Chêne gris
Roble gris

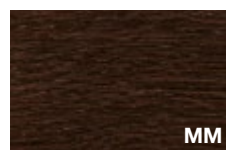

Rovere moro
Dark oak
Chêne foncé
Roble oscuro

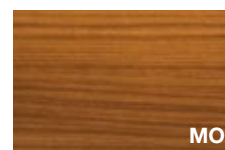

Noce Canaletto
Canaletto Walnut
Noyer Canaletto
Nogal Canaletto



Noce scuro
Dark walnut
Noyer foncé
Nogal oscuro



TES

Tessuto

Fabric | Tissu | Tejido

SCR

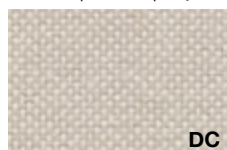

Beige
Beige
Beige
Beige



Grigio chiaro
Light grey
Gris clair
Gris claro



Ardesia
Ardesia
Ardesia
Pizarra



Blu avio
Avio blue
Bleu avio
Azul avio



Acquamarina
Aquamarine
Aigue-marine
Aguamarina

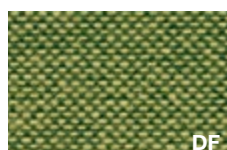

Verde primavera
Spring green
Vert printemps
Verde primavera

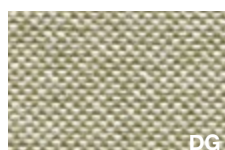

Salvia
Sage
Sauge
Salvia



Arancio
Orange
Orange
Naranja



Corallo
Coral
Corail
Coral

GOF

Metacrilato retrolaccato

Backpainted acrylic | Méthacrylate rétro-laqué | Metacrilato retrolacado



Bianco
White
Blanc
Blanco



Argento
Silver
Argent
Plata



Grigio scuro
Dark grey
Gris foncé
Gris oscuro



Noisette
Noisette
Noisette
Noisette

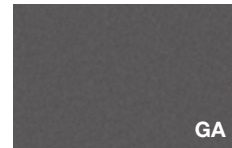

Ardesia
Ardesia
Ardesia
Pizarra



Moka
Mocha
Moka
Cafe

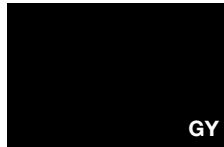

Nero
Black
Noir
Negro



Arancione
Orange
Orange
Naranja



Rosso "F"
Red "F"
Rouge "F"
Rojo "F"



Rubino
Ruby
Rubis
Rubi



Indaco
Indigo
Indigo
Azul Indigo



Azzurro
Blue
Bleu
Azul



Verde
Green
Vert
Verde



Cedro
Lime green
Vert Cédrat
Verde Cedro



GOF

Goffrato

Embossed | Gaufré | Lacado



Bianco
White
Blanc
Blanco



Argento
Silver
Argent
Plata



Grigio scuro
Dark grey
Gris foncé
Gris oscuro



Noisette
Noisette
Noisette
Noisette

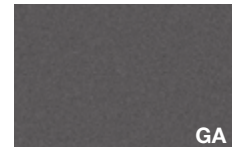

Ardesia
Ardesia
Ardesia
Pizarra

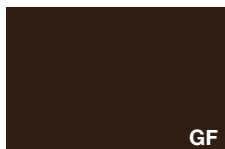

Moka
Mocha
Moka
Cafe



Nero
Black
Noir
Negro



Arancione
Orange
Orange
Naranja



Rosso "F"
Red "F"
Rouge "F"
Rojo "F"



Rubino
Ruby
Rubis
Rubi



Indaco
Indigo
Indigo
Azul Indigo



Azzurro
Blue
Bleu
Azul



Verde
Green
Vert
Verde



Cedro
Lime green
Vert Cédrat
Verde Cedro

Applicazioni finiture

Finish application | Application finitions | Aplicacion acabados



Piano
Top
Plateau
Sobre



Modesty panel
Modesty panel
Voile de fond
Faldón



Mobile di servizio
Service unit
Meuble de service
Mueble de servicio



Struttura
Structure
Structure
Structura



Profilo scrivania
Top edge
Chant plateau
Perfil sobre de mesa

Ambiente e sicurezza | Environment and safety | Environnement et sécurité | Medio ambiente y seguridad

Ecologia: Alea utilizza per i suoi prodotti e i suoi imballi materiali facilmente separabili e riciclabili. (Immagine 1)

Catena Di Custodia COC: Alea si impegna ad utilizzare materiali legnosi certificati FSC® e pannelli a base di legno con certificazione CARB2.

I pannelli CARB2 presentano un rilascio di formaldeide inferiore rispetto al pannello E1 comunemente utilizzato (classe E1 secondo il DM 10/10/2008).

I prodotti certificati FSC ® (License Code FSC-C118323) sono disponibili su richiesta: contattate i nostri uffici per maggiori informazioni. (Immagine 2)

LEED: Gli arredi di Alea possono contribuire al conseguimento del punteggio di certificazione LEED per i crediti indicati nei product badge. (Immagine 3)

Sistemi di Gestione certificati ISO 9001, ISO 14001, ISO 45001: Alea è attivamente impegnata nel raggiungere standard elevati di qualità e responsabilità attraverso l'adozione di sistemi di gestione certificati ISO per garantire prodotti e servizi di elevata qualità, in grado di soddisfare le aspettative dei clienti, di assicurare un ambiente di lavoro sicuro e di monitorare regolarmente l'impatto ambientale delle nostre attività. (Immagine 4)

Attestazione di prodotto: I prodotti Alea sono stati sottoposti a prove prestazionali presso laboratori di prova accreditati.

Copia dei rapporti di prova o delle attestazioni di conformità sono disponibili su richiesta. (Immagine 5)

Eco-friendly: Alea uses easily separable and recyclable materials for its products and packaging. (Image 1)

Chain of Custody (COC): Alea is committed to using FSC® certified wood materials and CARB2-certified wood-based panels. CARB2 panels have lower formaldehyde emissions compared to the commonly used E1 panels (class E1 according to the DM 10/10/2008). FSC® certified products (License Code FSC-C118323) are available upon request: please contact our offices for more information. (Image 2)

LEED: The A65 system can contribute to obtaining LEED certification points for the credits indicated in the product badges. (Image 3)

ISO 9001, ISO 14001, ISO 45001 Certified Management Systems: Alea is actively committed to achieving high standards of quality and responsibility through the adoption of ISO certified management systems to ensure high-quality products and services that meet customer expectations, provide a safe working environment, and regularly monitor the environmental impact of our activities. (Image 4)

Product Certification: Alea products have undergone performance tests by accredited testing laboratories. Copies of test reports or certificates of conformity are available upon request. (Image 5)



Immagine 1



Immagine 2



Immagine 3



Immagine 4



Immagine 5

Ambiente e sicurezza | Environment and safety | Environnement et sécurité | Medio ambiente y seguridad

Écologie: Alea utilise pour ses produits et ses emballages des matériaux facilement séparables et recyclables. (Image 1)

Chaîne de contrôle COC: Alea a à cœur d'utiliser des matériaux en bois certifiés FSC® et des panneaux à base de bois avec la certification CARB2.

Les panneaux CARB2 présentent une émission de formaldéhyde inférieure à celle des panneaux E1 couramment utilisés (classe E1 selon le DM 10/10/2008). Les produits certifiés FSC® (Code de licence FSC-C118323) sont disponibles sur demande : veuillez contacter nos bureaux pour plus d'informations. (Image 2)

LEED: Le système A65 peut contribuer à l'obtention des points de certification LEED pour les crédits indiqués dans les badges produits. (Image 3)

Systèmes de gestion certifiés ISO 9001, ISO 14001, ISO 45001: Alea s'engage activement à atteindre des normes élevées de qualité et de responsabilité à travers l'adoption de systèmes de gestion certifiés ISO pour garantir des produits et services de haute qualité, répondre aux attentes des clients, assurer un environnement de travail sûr et surveiller régulièrement l'impact environnemental de nos activités. (Image 4)

Attestation de produit: Les produits Alea ont été soumis à des tests de performance dans des laboratoires d'essais accrédités. Des copies des rapports de tests ou des certificats de conformité sont disponibles sur demande. (Image 5)

Ecología: Alea utiliza para sus productos y embalajes materiales fácilmente separables y reciclables. (Imagen 1)

Cadena de Custodia COC: Alea se compromete a utilizar materiales de madera certificados por FSC® y paneles a base de madera con certificación CARB2.

Los paneles CARB2 presentan una emisión de formaldehído inferior en comparación con los paneles E1 comúnmente utilizados (clase E1 según el DM 10/10/2008). Los productos certificados por FSC® (Código de Licencia FSC-C118323) están disponibles bajo solicitud: por favor contacte a nuestras oficinas para más información. (Imagen 2)

LEED: El sistema A65 puede contribuir a la consecución de la puntuación de certificación LEED para los créditos indicados en los product badges. (Imagen 3)

Sistemas de Gestión Certificados ISO 9001, ISO 14001, ISO 45001: Alea está comprometida activamente en alcanzar altos estándares de calidad y responsabilidad mediante la adopción de sistemas de gestión certificados por ISO para garantizar productos y servicios de alta calidad, que cumplen con las expectativas de los clientes, aseguran un entorno de trabajo seguro y monitorean regularmente el impacto ambiental de nuestras actividades. (Imagen 4)

Certificación de Producto: Los productos Alea han sido sometidos a pruebas de rendimiento en laboratorios acreditados. Las copias de los informes de prueba o los certificados de conformidad están disponibles bajo solicitud. (Imagen 5)



Immagine 1



Immagine 2



Immagine 3



Immagine 4



Immagine 5

Le immagini dei prodotti visibili all'interno di questo catalogo sono inserite a scopo puramente indicativo
The images of the products visible in this catalogue are included for information purposes only
Les images des produits visibles dans ce catalogue sont incluses à titre informatif uniquement
Las imágenes de los productos visibles en este catálogo se incluyen sólo con fines informativos

Concept, visual & graphic design

Alea marketing + communication

Design

Mirto Antonel

Art direction

Mirto Antonel

Si ringrazia M.artedesign

martedesign.it

AF/CACB/AB



GLOBAL HEADQUARTERS AND SHOWROOM : Via Col de Rust, 19 - 33070 Sarone (PN) - Italia : Tel ++39 0434 777 333
email: info@aleaoffice.com **PARIS SHOWROOM** : 176 Avenue Charles de Gaulle 92200, Neuilly-sur-Seine - France **NORTH AMERICAN
HEADQUARTERS** : Midtown 2, 3449 NE 1st Avenue L-32, Miami, FL 33137 - USA : Tel ++1 305 470 1200 - email: info@alea-usa.com
ALEA UK OFFICE AND SHOWROOM : 50-54 Clerkenwell Road, London EC1M 5PS - email: info@aleaoffice.com