

alea

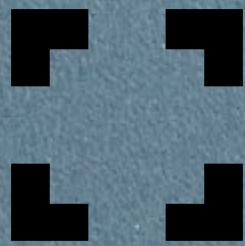

**Italo**\_forty

---

workstations

# Solo l'essenziale

Il pratico sistema di fissaggio a molla, rende Italo\_forty una struttura solida, affidabile e performante nel tempo.

The practical spring fastening system makes Italo\_forty a solid, reliable and long-lasting structure.

Le système pratique de fixation par ressort fait d'Italo\_forty une structure solide, fiable et durable.

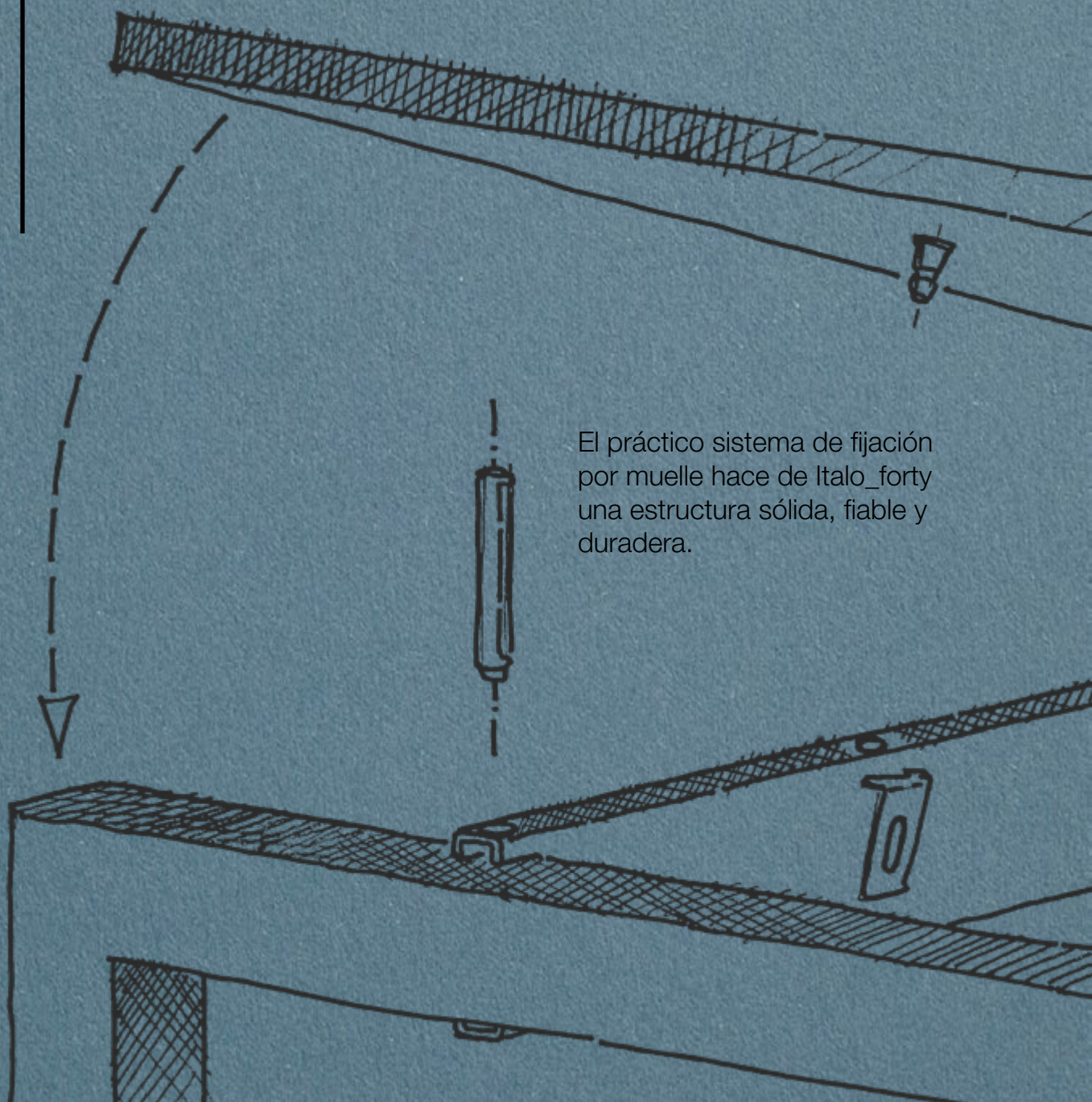

El práctico sistema de fijación por muelle hace de Italo\_forty una estructura sólida, fiable y duradera.



## Sistema intelligente

Italo\_forty è un sistema dalle sorprendenti prerogative tecniche ma dai costi contenuti. Si compone di una struttura metallica trave/cavalletto di supporto ai piani di spessore 18 mm.

**Smart system** Italo\_forty system combines great technical features with cost efficient components. A metal structure with horizontal beams and straight legs, supports tops 18 mm (11/16") thick.





**Système intelligent** Italo\_forty est un système aux surprenantes caractéristiques techniques mais au prix contenu. Le système se compose d'une structure métallique poutre/pied arche à support de plateaux de 18 mm d'épaisseur.

**Sistema inteligente** Italo\_forty es un sistema de sorprendentes características técnicas a un precio razonable. El sistema consta de una estructura metálica de patas/vigas que soporta superficies de 18 mm de espesor.







## Fissaggio

Il fissaggio dei piani alla struttura avviene grazie a perni conici che si inseriscono su molle metalliche applicate alle travi. Il piano si installa solo a pressione, senza l'utilizzo di viti. Le travi orizzontali forniscono anche il supporto agli accessori.





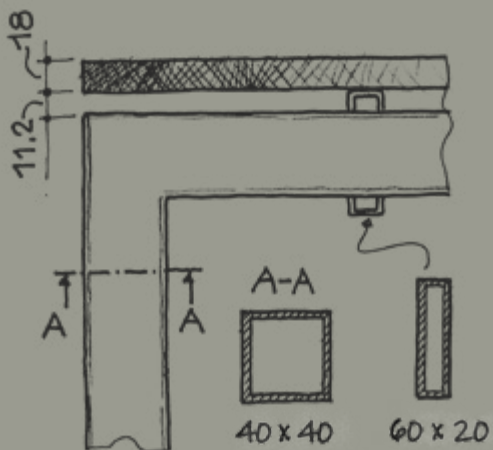

**Fixing** the worksurface is secured to the structure through conical pins which are inserted onto metal springs applied to the beams. The table top is installed only by pressure, without the use of screws. The horizontal beams also provide support to several accessories.



**Fixation** la fixation des plateaux sur la structure se fait grâce à des goujons coniques qui sont insérés dans des ressorts métalliques intégrés aux poutres. Le plan de travail est installé simplement par pression, aucune vis. Les poutres horizontales servent également de support aux accessoires.

**Fijación** los sobres de mesa, se conectan a la base por medio de pernos que se introducen en resortes metálicos aplicados en las vigas. La sola presión del peso es suficiente para instalar el top, sin necesidad de tornillos. Las vigas horizontales también sirven para colocar los accesorios.





Al tavolo Italo\_forty possiamo abbinare Q18, sistema modulare di librerie realizzato con un profilo in alluminio a sezione quadrata da 18 mm e integrabile con moduli contenitori e piani espositori.



Italo\_forty table can be paired with Q18, a modular bookcase system made with an 18 mm (11/16") square section aluminium profile that can be integrated with storage modules and display shelves.

La table Italo\_forty peut être assortie à Q18, système modulaire de rayonnage réalisé avec un profil en aluminium à section carrée de 18 mm pouvant être complété avec rangements et présentoirs.

A la mesa Italo\_forty podemos combinar Q18, sistema de estantería modular hecho con perfil de aluminio de sección cuadrada de 18 mm que se puede integrar con módulos contenedores y estantes expositores.







**Options** Italo\_forty tops can be in melamine, with a solid colour or wood-effect finish, or in back-lacquered glass, also in the anti-fingerprint version.

**Options** Les plateaux Italo\_forty peuvent être en mélamine, avec finition unie ou effet bois, ou en verre laqué, également dans la version antitaches.

**Opciones** Los sobres Italo\_forty pueden ser de melamina, con un acabado de color sólido o de efecto madera, o de cristal retro-lacado, también en la versión anti-huella.







## Opzioni

I piani Italo\_forty possono essere in melaminico, con finitura in tinta unita o effetto legno, oppure in vetro retrolaccato anche nella versione antimpronta.





## Contentori

I sistemi di contenitori ad ante battenti Remo e ad ante scorrevoli Romolo si abbinano con i tavoli Italo\_forty condividendo le molte opzioni di colore.





**Storage** Italo\_forty can be paired with Remo hinged doors storage system and Romolo sliding doors cabinets. They all share the same range of finishes.

**Armoires de rangement**

Les armoires à portes battantes Remo et à portes coulissantes Romolo s'assortent bien avec les tables Italo\_forty grâce aux nombreuses options couleur communes.

**Contenedores** Los sistemas de almacenamiento de puertas batientes Remo y de puertas corredizas Romolo se combinan con las mesas. Italo\_forty compartiendo las múltiples opciones de color.









## Accessori

Il piano può essere dotato di asola passacavi o di spazzola morbida per consentire l'uscita dei cavi sul piano lavoro. Il bench Italo\_forty può essere attrezzato con corpetti contenitori, a giorno, condivisi e screen agganciati in tessuto tackable.

**Accessories** The top can be provided with grommets or soft brush flip top that allow cables to reach easily the top of the worksurface. Screens may be tackable and cubbies can be added and shared in a bench configuration.

**Accessoires** Le plateau peut être équipé avec une brosse douce qui permet la sortie des câbles sur le plan de travail. Le poste double Italo\_forty peut recevoir soit des petits rangements ouverts partagés soit des écrans de séparation "tackable" en tissu.





**Accesorios** La superficie de trabajo puede llevar una ranura pasacables o un cepillo suave para permitir la salida de los cables en la encimera. El bench Italo\_forty puede ser equipado con contenedores aéreos, abiertos, compartidos y pantallas enganchadas en tejido pinchable.











## Cablaggio

Il sistema di traslazione dei piani lavoro nelle postazioni contrapposte consente un facile accesso al vano centrale dove vengono raccolti i cavi. Questo spazio condiviso può essere attrezzato con una vasca in metallo o una rete metallica effetto cromato.

**Wiring** In the face to face stations, Italo\_forty sliding system allows easy access to the center through where the cables run. The channel can be in metal or in a grid chrome version.

**Câblage** L'option des plateaux à coulisse permet, en hâlant la surface de travail, de libérer l'accès à l'aire de connexion où se trouve le câblage. Celui-ci est véhiculé par des canaux réalisés soit en maillage d'acier chromé soit en tôle peinte pliée en U.

**Cableado** Las superficies con sistema deslizable en los escritorios compartidos permite un acceso fácil al canal central que distribuye los cables y conexiones. Este canal compartido puede ser una canasta en rejilla de metal cromado o una bandeja metálica en U.





## Sala lettura

Quando abbinato al sistema di librerie modulari Q18, Italo\_forty si rivela adatto per l'arredamento di ambienti come le sale lettura. Le forme geometriche creano spazi di lavoro accoglienti e attraenti







**Libraries** When paired with the Q18 modular shelving system, Italo\_forty is suitable for furnishing environments such as libraries. Geometric shapes create welcoming and comfortable areas.

**Salles de lecture** Associé au système de rayonnage modulaire Q18, Italo\_forty devient la solution idéale pour l'ameublement d'espaces tels que salles de lecture. Les formes géométriques créent d'espaces de travail confortables et séduisants.

**Ambientes de lectura** Cuando se combina con el sistema de estantería modular Q18, Italo\_forty demuestra ser adecuado para el amueblamiento de interiores como salas de lectura. Las formas geométricas crean espacios de trabajo acogedores y atractivos.







## Riunioni

Italo\_forty consente, grazie alla propria struttura, di realizzare tavoli riunione con campata sino a 300 cm senza l'ausilio di supporti intermedi. Ai tavoli si possono abbinare eleganti librerie modulari in varie finiture oppure mobili contenitori.

**Meetings** Italo\_forty beam system allows the building of conference tables 300 cm (10 feet) long without an intermediate support. These tables can be paired with modular bookcases and elegant cabinets.

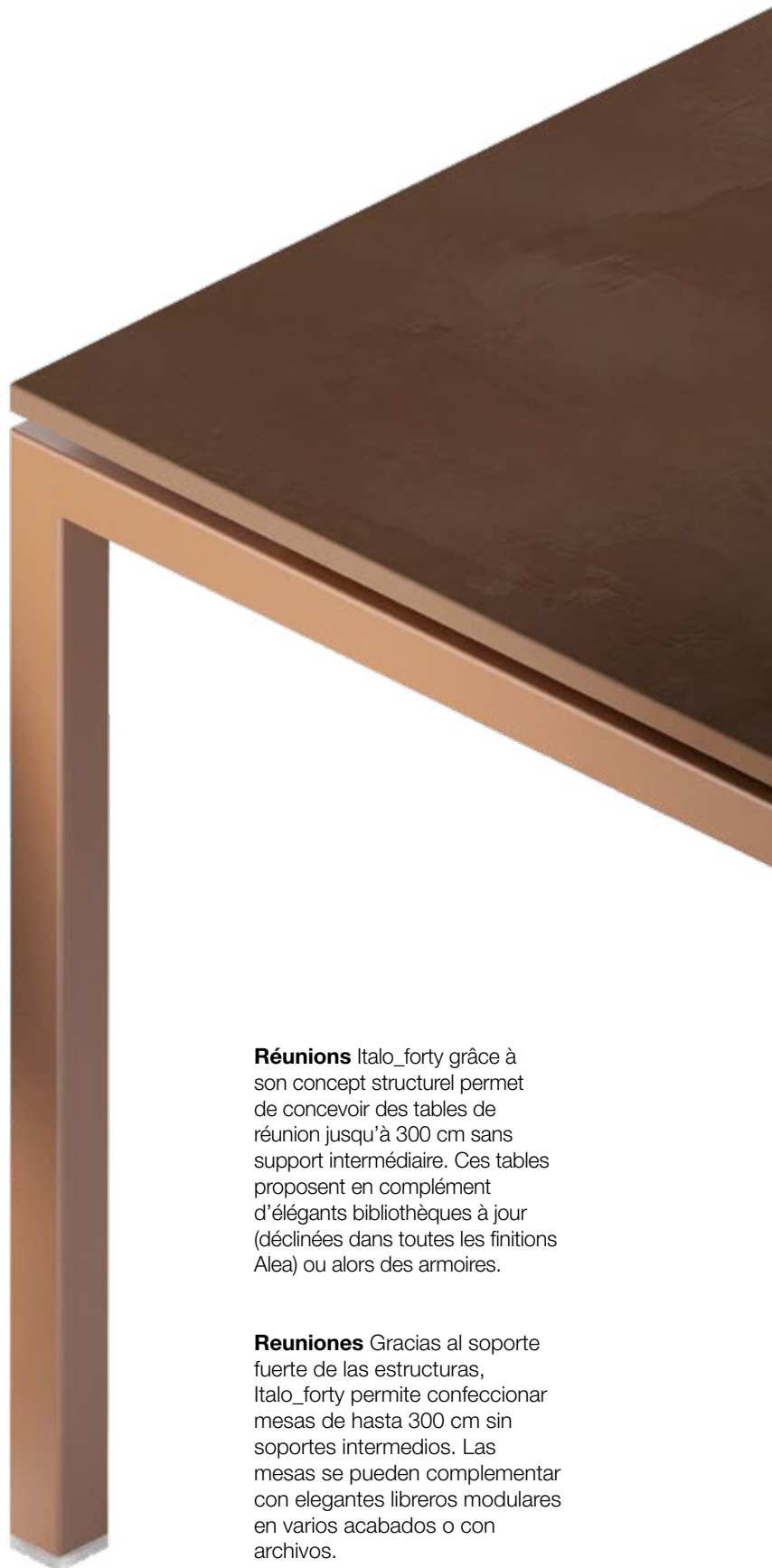

**Réunions** Italo\_forty grâce à son concept structurel permet de concevoir des tables de réunion jusqu'à 300 cm sans support intermédiaire. Ces tables proposent en complément d'élégants bibliothèques à jour (déclinées dans toutes les finitions Alea) ou alors des armoires.

**Reuniones** Gracias al soporte fuerte de las estructuras, Italo\_forty permite confeccionar mesas de hasta 300 cm sin soportes intermedios. Las mesas se pueden complementar con elegantes librerías modulares en varios acabados o con archivos.

①



1. Tavoli lunghezza extra, 300 mm | 2. Accessori agganciati alla struttura (screen, modesty panel, porta CPU) | 3. Rapido fissaggio del top | 4. Componenti della struttura | 5. Gamba regolabile in altezza | 6. Piano traslabile | 7. Design lineare

②



1. Extra long tables, 300 mm (10 feet) | 2. Accessories hanged to the structure (screen, modesty panel, CPU holder) | 3. Quick top linking | 4. Structure components | 5. Height adjustable leg | 6. Sliding desk top | 7. Clean design

③



1. Tables extra-longues, 300 mm | 2. Accessoires fixés à la structure (écran, voile de fond, Support U.C.) | 3. Fixation rapide du top | 4. Composants de la structure | 5. Pied réglable en hauteur | 6. Plateau coulissant | 7. Design linéaire

1. Mesas de longitud extra, 300 mm | 2. Accesorios enganchados en la estructura (panel, faldón, porta CPU) | 3. Anclaje rápido del sobre mesa | 4. Componentes de la estructura | 5. Pata regulable en altura | 6. Plateau coulissant | 7. Diseño lineal

④



⑤



⑥



⑦

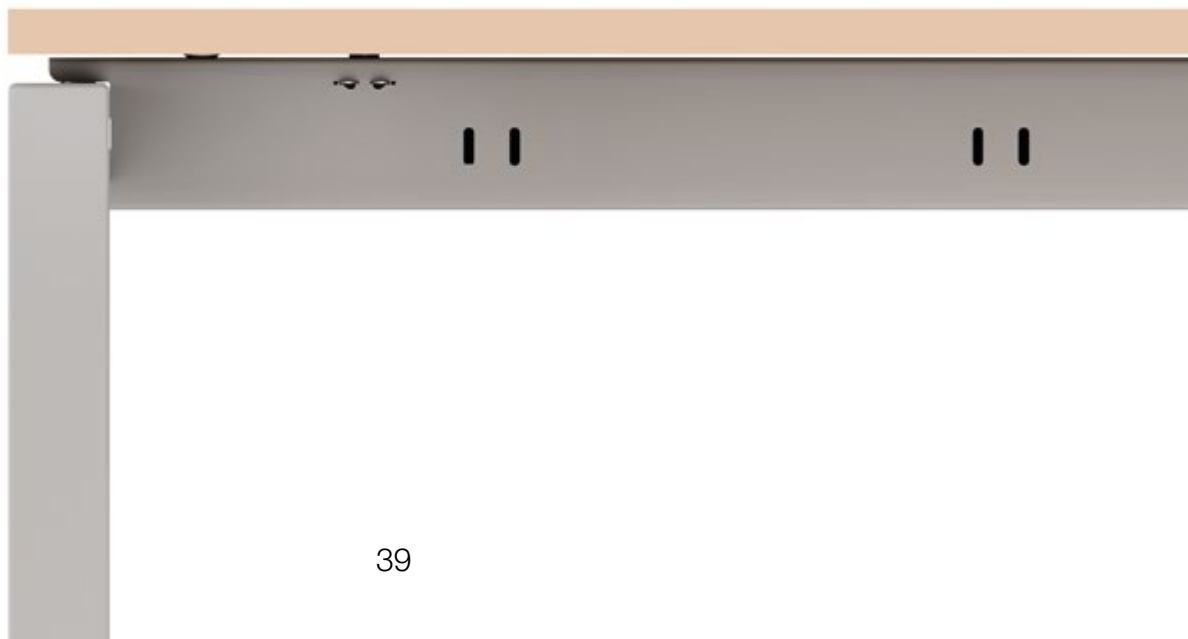

8

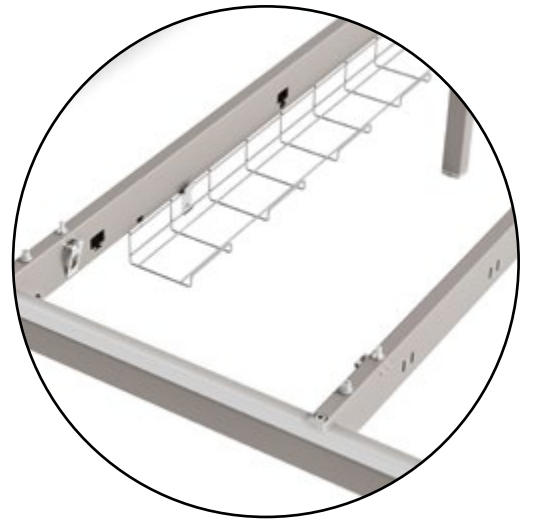

8. Cestello portacavi in filo d'acciaio | 9. Canala portacavi in metallo | 10. Gestione dei cavi nella soluzione bench | 11. Canale metalliche magnetiche per il transito verticale dei cavi | 12. Coppia di carter per la salita cavi

8. Panier passecables en fil d'acier | 9. Goulotte passecables en tôle d'acier | 10. Gestion des câbles dans la solution bench | 11. Goulottes verticales magnétiques pour passage câbles | 12. Goulotte double verticale passecables

8. Basket for cable management | 9. Metal tray for cable management | 10. Cable management for bench solutions | 11. Magnetic vertical cable duct | 12. Double vertical cable duct

8. Viga portacables en rejilla de acero | 9. Viga portacables | 10. Gestión de cables en la solución bench | 11. Canalización magnética para salida cables | 12. Canalización central para salida cables

9





10



11

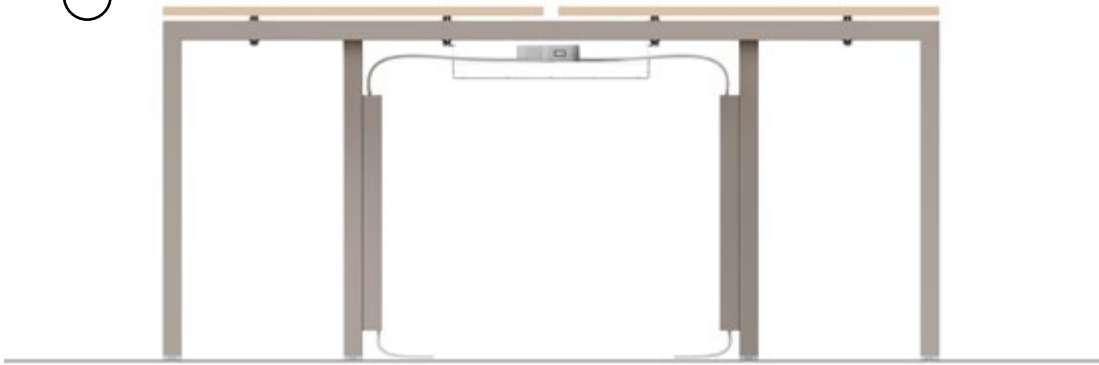

12



**Piani** | Desk tops | Plateaux | Sobres



**Melaminico/vetro**  
 Melamine/glass  
 Mélaminé/verre  
 Melaminico/vidrio

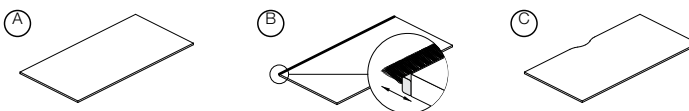

**Piani fissi o traslabili A. semplici, B. con spazzolino, C. con scanso passacavi**

Fixed or sliding desk tops A. simple, B. with brush, C. with frontal shaping for cable transit  
 Plateaux fixes ou coulissants A. simples, B. avec brosse passecables, C. avec façonnage frontal pour le passage des câbles  
 Sobres fijas o deslazantes A. simples, B. con escobillas, C. con pasacables frontal

**Gambe** | Legs | Pieds | Patas

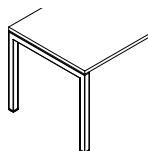

**Metallo verniciato epossidico**  
 Metal epoxy painted  
 Métal peint epoxy  
 Metal pintado epoxi

**Gli screen sono disponibili nelle finiture: melaminico, goffrato, metacrilato, tessuto**

Screens are available in the following finishes: melamine, embossed, acrylic, fabric,  
 Les écrans sont disponibles dans les finitions: mélaminé, gaufré, méthacrylate, tissu  
 Los paneles están disponibles en los siguientes acabados: melaminico, lacado, metacrilato, tejido

**Scrivanie** | desks | bureaux | mesas

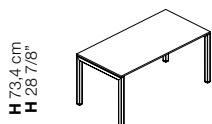

H 73,4 cm  
 H 28 7/8"

L 100/120/140/160/180/200 - P 80/90 cm  
 W 39 3/8"-47 1/4"-55 1/8"-63"-70 7/8"-78 3/4" - D 31 1/2"-35 3/8"

**Dattilo** | returns | retours | alas

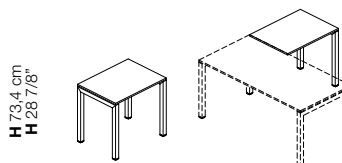

H 73,4 cm  
 H 28 7/8"

L 80/100/120 - P 60 cm  
 W 31 1/2"-39 3/8"-47 1/4" - D 23 5/8"

**Tavoli riunione** | meeting tables | tables de réunion | mesas de juntas

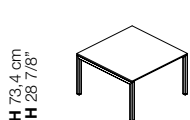

H 73,4 cm  
 H 28 7/8"

L 120/160 - P 123/163 cm  
 W 47 1/4"-63" - D 48 3/8"-64 1/8"

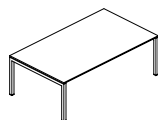

L 210/240/300 - P 123 cm  
 W 82 5/8"-94 1/2"-118 1/8" - D 48 3/8"

**Esempi composizioni** | composition example | exemples de compositions | ejemplos de composiciones

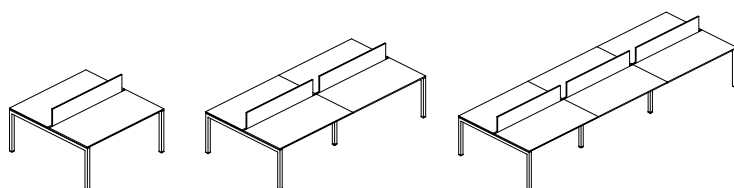

# Finiture | Finishes | Finitions | Acabados

## MEL

### Melaminico

Melamine | Mélaminé | Melaminico

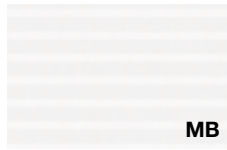

**Bianco rigato**  
Rippled effect white  
Blanc avec rayures en sérigraphie  
Blanco rayado

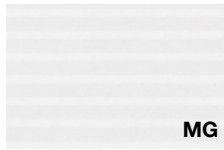

**Grigio rigato**  
Rippled effect grey  
Gris avec rayures en sérigraphie  
Gris rayado



**Nichel**  
Nickel  
Nickel  
Níquel



**Cacao**  
Cocoa  
Cacao  
Cacao



**Bianco**  
White  
Blanc  
Blanco

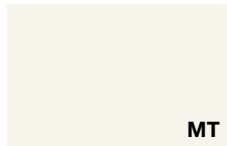

**Talco**  
Talco  
Talco  
Talco



**Ocra**  
Ochre  
Ocre  
Ocre



**Terracotta**  
Terracotta  
Terre cuite  
Terracota



**Safari**  
Safari  
Safari  
Safari



**Noisette**  
Noisette  
Noisette  
Noisette



**Verde**  
Green  
Vert  
Verde



**Nero**  
Black  
Noir  
Negro



**Blu notte**  
Night blue  
Bleu nuit  
Azul noche

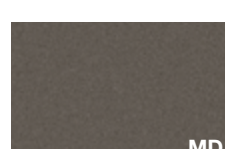

**Ardesia**  
Ardesia  
Ardesia  
Pizarra



**Rovere chiaro**  
Light oak  
Chêne clair  
Roble claro



**Rovere americano**  
American oak  
Chêne américain  
Roble americano



**Rovere grigio**  
Grey oak  
Chêne gris  
Roble gris

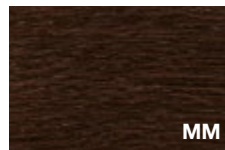

**Rovere moro**  
Dark oak  
Chêne foncé  
Roble oscuro

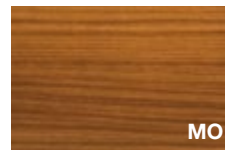

**Noce Canaletto**  
Canaletto Walnut  
Noyer Canaletto  
Nogal Canaletto



**Noce scuro**  
Dark walnut  
Noyer foncé  
Nogal oscuro

## GOF

### Goffrato

Embossed | Gaufré | Lacado



**Moka**  
Mocha  
Moka  
Cafe



**Indaco**  
Indigo  
Indigo  
Azul Indigo



**Rubino**  
Ruby  
Rubis  
Rubi



**Cedro**  
Lime green  
Vert Cédrat  
Verde Cedro



**Argento**  
Silver  
Argent  
Plata



**Bianco**  
White  
Blanc  
Blanco



**Nero**  
Black  
Noir  
Negro



**Rosso "F"**  
Red "F"  
Rouge "F"  
Rojo "F"



**Arancione**  
Orange  
Orange  
Naranja



**Grigio scuro**  
Dark grey  
Gris foncé  
Gris oscuro



**Azzurro**  
Blue  
Bleu  
Azul



**Verde**  
Green  
Vert  
Verde

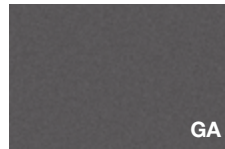

**Ardesia**  
Ardesia  
Ardesia  
Pizarra



**Noisette**  
Noisette  
Noisette  
Noisette

## MTC

### Metacrilato

Acrylic | Méthacrylate | Metacrilato



**Bianco opalino**  
Opaline white  
Blanc opalin  
Blanco opaco

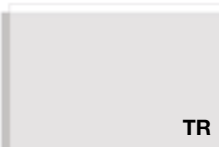

**Trasparente**  
Transparent  
Transparent  
Transparente



**Rosso trasparente**  
Red transparent  
Rouge transparent  
Rojo transparente



**Blu trasparente**  
Blue transparent  
Bleu transparent  
Azul transparente



**Bianco satinato**  
Satin-finish white  
Blanc satiné  
Blanco satinado



**Grigio fumè satinato**  
Satin-finish smoky grey  
Gris satiné  
Gris satinado



**Arancione satinato**  
Satin-finish orange  
Orange satiné  
Naranja satinado



**Blu satinato**  
Satin-finish blue  
Bleu satiné  
Azul satinado



**Verde satinato**  
Satin-finish green  
Vert satiné  
Verde satinado

## TES

### Tessuto

Fabric | Tissu | Tejido



**Beige**  
Beige  
Beige  
Beige

DC

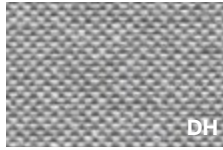

**Grigio chiaro**  
Light grey  
Gris clair  
Gris claro

DH



**Ardesia**  
Ardesia  
Ardesia  
Pizarra

DI



**Blu avio**  
Avio blue  
Bleu avio  
Azul avio

DD



**Acquamarina**  
Aquamarine  
Alugue-marine  
Aguamarina

DE

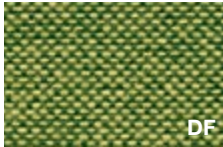

**Verde primavera**  
Spring green  
Vert printemps  
Verde primavera

DF

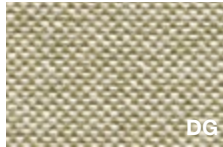

**Salvia**  
Sage  
Sauge  
Salvia

DG



**Arancio**  
Orange  
Orange  
Naranja

DB



**Corallo**  
Coral  
Corail  
Coral

DA

## EPX

### Epossidico

Epoxy | Époxy | Epoxi



**Bianco**  
White  
Blanc  
Blanco

EB

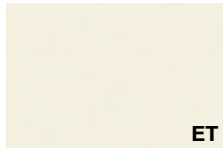

**Talco**  
Talco  
Talco  
Talco

ET



**Grigio**  
Grey  
Gris  
Gris

EG



**Beige Arizona**  
Arizona beige  
Beige Arizona  
Beige Arizona

YD



**Noisette**  
Noisette  
Noisette  
Noisette

EO



**Safari**  
Safari  
Safari  
Safari

EK



**Rame**  
Copper  
Cuivre  
Cobre

EE



**Terracotta**  
Terracotta  
Terre cuite  
Terracota

EH

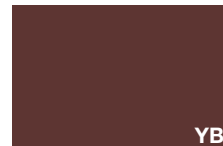

**Rosso Jaipur**  
Jaipur red  
Rouge Jaipur  
Rojo Jaipur

YB



**Bronzo**  
Bronze  
Bronze  
Bronce

EZ



**Blu notte**  
Night blue  
Bleu nuit  
Azul noche

YQ



**Grigio Bromo**  
Bromo grey  
Gris Bromo  
Gris Bromo

YC

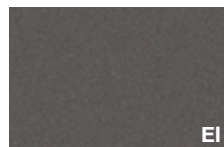

**Ardesia**  
Ardesia  
Ardesia  
Pizarra

EI



**Verde Comodoro**  
Comodoro green  
Vert Comodoro  
Verde Comodoro

YV



**Nero**  
Black  
Noir  
Negro

EN

## Applicazioni finiture

Finish application | Application finitions | Aplicacion acabados



**Piano**  
Top  
Plateau  
Sobre



**Modesty panel**  
Modesty panel  
Voile de fond  
Faldón



**Screen**  
Screen  
Écran  
Panel



**Struttura**  
Structure  
Structure  
Structura

# Ambiente e sicurezza | Environment and safety | Environnement et sécurité | Medio ambiente y seguridad

**Ecologia:** Alea utilizza per i suoi prodotti e i suoi imballi materiali facilmente separabili e riciclabili. (Immagine 1)

**Catena Di Custodia COC:** Alea si impegna ad utilizzare materiali legnosi certificati FSC® e pannelli a base di legno con certificazione CARB2.

I pannelli CARB2 presentano un rilascio di formaldeide inferiore rispetto al pannello E1 comunemente utilizzato (classe E1 secondo il DM 10/10/2008).

I prodotti certificati FSC ® (License Code FSC-C118323) sono disponibili su richiesta: contattate i nostri uffici per maggiori informazioni. (Immagine 2)

**LEED:** Gli arredi di Alea possono contribuire al conseguimento del punteggio di certificazione LEED per i crediti indicati nei product badge. (Immagine 3)

**Sistemi di Gestione certificati ISO 9001, ISO 14001, ISO 45001:** Alea è attivamente impegnata nel raggiungere standard elevati di qualità e responsabilità attraverso l'adozione di sistemi di gestione certificati ISO per garantire prodotti e servizi di elevata qualità, in grado di soddisfare le aspettative dei clienti, di assicurare un ambiente di lavoro sicuro e di monitorare regolarmente l'impatto ambientale delle nostre attività. (Immagine 4)

**Attestazione di prodotto:** I prodotti Alea sono stati sottoposti a prove prestazionali presso laboratori di prova accreditati.

Copia dei rapporti di prova o delle attestazioni di conformità sono disponibili su richiesta. (Immagine 5)

**Eco-friendly:** Alea uses easily separable and recyclable materials for its products and packaging. (Image 1)

**Chain of Custody (COC):** Alea is committed to using FSC® certified wood materials and CARB2-certified wood-based panels. CARB2 panels have lower formaldehyde emissions compared to the commonly used E1 panels (class E1 according to the DM 10/10/2008). FSC® certified products (License Code FSC-C118323) are available upon request: please contact our offices for more information. (Image 2)

**LEED:** The A65 system can contribute to obtaining LEED certification points for the credits indicated in the product badges. (Image 3)

**ISO 9001, ISO 14001, ISO 45001 Certified Management Systems:** Alea is actively committed to achieving high standards of quality and responsibility through the adoption of ISO certified management systems to ensure high-quality products and services that meet customer expectations, provide a safe working environment, and regularly monitor the environmental impact of our activities. (Image 4)

**Product Certification:** Alea products have undergone performance tests by accredited testing laboratories. Copies of test reports or certificates of conformity are available upon request. (Image 5)



# Ambiente e sicurezza | Environment and safety | Environnement et sécurité | Medio ambiente y seguridad

**Écologie:** Alea utilise pour ses produits et ses emballages des matériaux facilement séparables et recyclables. (Image 1)

**Chaîne de contrôle COC:** Alea a à cœur d'utiliser des matériaux en bois certifiés FSC® et des panneaux à base de bois avec la certification CARB2.

Les panneaux CARB2 présentent une émission de formaldéhyde inférieure à celle des panneaux E1 couramment utilisés (classe E1 selon le DM 10/10/2008). Les produits certifiés FSC® (Code de licence FSC-C118323) sont disponibles sur demande : veuillez contacter nos bureaux pour plus d'informations. (Image 2)

**LEED:** Le système A65 peut contribuer à l'obtention des points de certification LEED pour les crédits indiqués dans les badges produits. (Image 3)

**Systèmes de gestion certifiés ISO 9001, ISO 14001, ISO 45001:** Alea s'engage activement à atteindre des normes élevées de qualité et de responsabilité à travers l'adoption de systèmes de gestion certifiés ISO pour garantir des produits et services de haute qualité, répondre aux attentes des clients, assurer un environnement de travail sûr et surveiller régulièrement l'impact environnemental de nos activités. (Image 4)

**Attestation de produit:** Les produits Alea ont été soumis à des tests de performance dans des laboratoires d'essais accrédités. Des copies des rapports de tests ou des certificats de conformité sont disponibles sur demande. (Image 5)

**Ecología:** Alea utiliza para sus productos y embalajes materiales fácilmente separables y reciclables. (Imagen 1)

**Cadena de Custodia COC:** Alea se compromete a utilizar materiales de madera certificados por FSC® y paneles a base de madera con certificación CARB2.

Los paneles CARB2 presentan una emisión de formaldehído inferior en comparación con los paneles E1 comúnmente utilizados (clase E1 según el DM 10/10/2008). Los productos certificados por FSC® (Código de Licencia FSC-C118323) están disponibles bajo solicitud: por favor contacte a nuestras oficinas para más información. (Imagen 2)

**LEED:** El sistema A65 puede contribuir a la consecución de la puntuación de certificación LEED para los créditos indicados en los product badges. (Imagen 3)

**Sistemas de Gestión Certificados ISO 9001, ISO 14001, ISO 45001:** Alea está comprometida activamente en alcanzar altos estándares de calidad y responsabilidad mediante la adopción de sistemas de gestión certificados por ISO para garantizar productos y servicios de alta calidad, que cumplen con las expectativas de los clientes, aseguran un entorno de trabajo seguro y monitorean regularmente el impacto ambiental de nuestras actividades. (Imagen 4)

**Certificación de Producto:** Los productos Alea han sido sometidos a pruebas de rendimiento en laboratorios acreditados. Las copias de los informes de prueba o los certificados de conformidad están disponibles bajo solicitud. (Imagen 5)



1.



2.



3.



4.



5.

**Le finiture contenute nella stampa sono puramente indicative e non sono di riferimento per le forniture del prodotto**

Due to the printing process, finishes shown in this document are for illustration only. The finish on the final item may differ slightly from the printed illustration  
Les finitions contenues dans l'impression sont purement indicatives et ne sont pas pertinentes pour les fournitures du produit  
Los acabados contenidos en la impresión son puramente indicativos y no son de referencia para los suministros del producto



**Concept & graphic design**

Alea marketing + communication

**Design**

Filippon & Mirto Antonel

**Art direction**

Mirto Antonel

AD/CACC/AG

**Le immagini dei prodotti visibili all'interno di questo catalogo sono inserite a scopo puramente indicativo**

The images of the products visible in this catalogue are included for information purposes only

Les images des produits visibles dans ce catalogue sont incluses à titre informatif uniquement

Las imágenes de los productos visibles en este catálogo se incluyen sólo con fines informativos

**alea**  
aleaoffice.com



**GLOBAL HEADQUARTERS AND SHOWROOM** : Via Col de Rust, 19 - 33070 Sarone (PN) - Italia : Tel ++39 0434 777 333  
email: info@aleaoffice.com **PARIS SHOWROOM** : 176 Avenue Charles de Gaulle 92200, Neuilly-sur-Seine - France **NORTH AMERICAN  
HEADQUARTERS** : Midtown 2, 3449 NE 1st Avenue L-32, Miami, FL 33137 - USA : Tel ++1 305 470 1200 - email: info@alea-usa.com  
**ALEA UK OFFICE AND SHOWROOM** : 50-54 Clerkenwell Road, London EC1M 5PS - email: info@aleaoffice.com