

alea

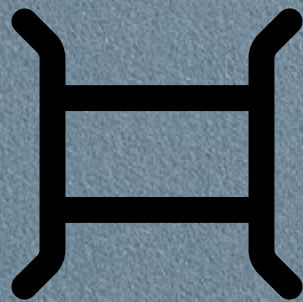

Rendez-Vous

workstations

Lo spazio ibrido diventa realtà

Rendez-Vous nasce
come collezione
adattabile alle
diverse funzioni
dell'ambiente
di lavoro
contemporaneo.

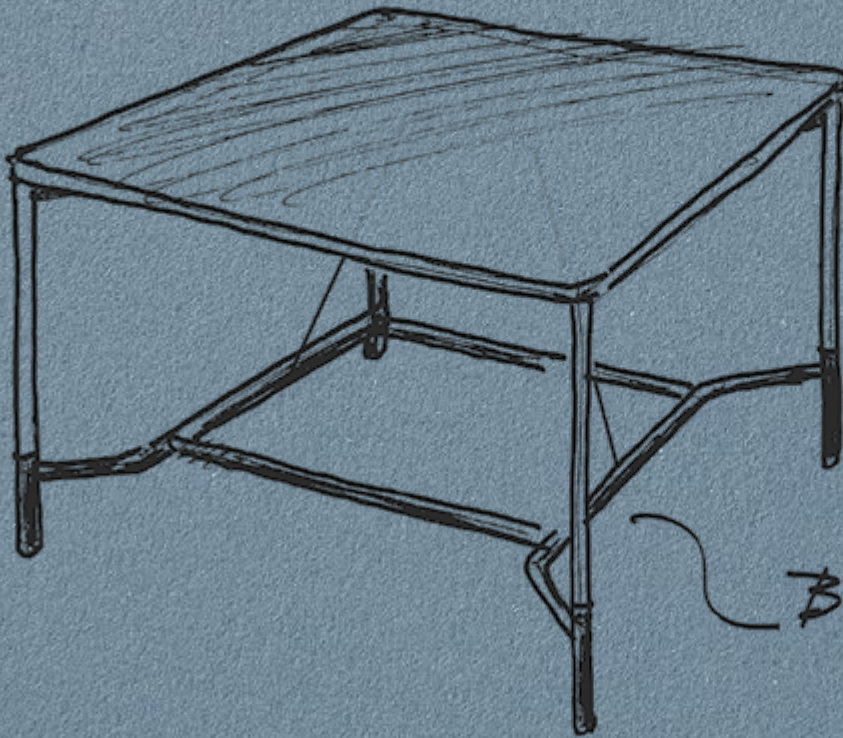

BICOLOR

Rendez-Vous was created
as a collection adaptable to
the multiple functions of the
contemporary workplace.

Rendez-Vous a été créé
comme une collection
adaptable aux différentes
fonctions de l'environnement
de travail contemporain.

Rendez-Vous nasce como
una colección adaptable
a las diferentes funciones
del entorno de trabajo
contemporáneo.

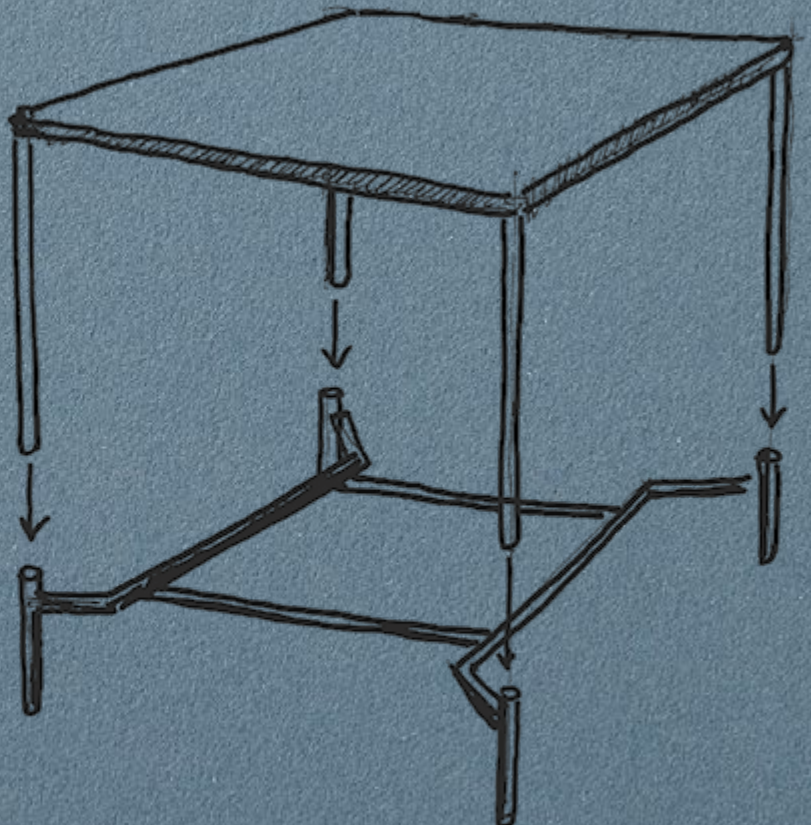





Condivisione

Rendez-Vous è stato progettato per agevolare la condivisione dello spazio. In un'epoca dove la flessibilità in termini di modi e luoghi diventa un must, questa collezione si apre a molteplici interpretazioni.





Tavolo | Table | Table | Mesa **Fin.** MD, EI, EE
L/P 160 H 105 cm | W/D 63" H 41 3/8"

Sharing Rendez-Vous is designed to create collaboration spaces. In an age where flexibility in terms of ways and places is becoming a must, this collection is open to multiple interpretations.

Partager Rendez-Vous est conçu pour créer des espaces de collaboration. À une époque où la flexibilité en termes de moyens et de lieux devient un must, cette collection est ouverte à de multiples interprétations.

Compartir Rendez-Vous ha sido diseñado para facilitar el uso compartido del espacio. En una época en la que la flexibilidad en términos de modos y lugares se hace imprescindible, esta colección se abre a múltiples interpretaciones.

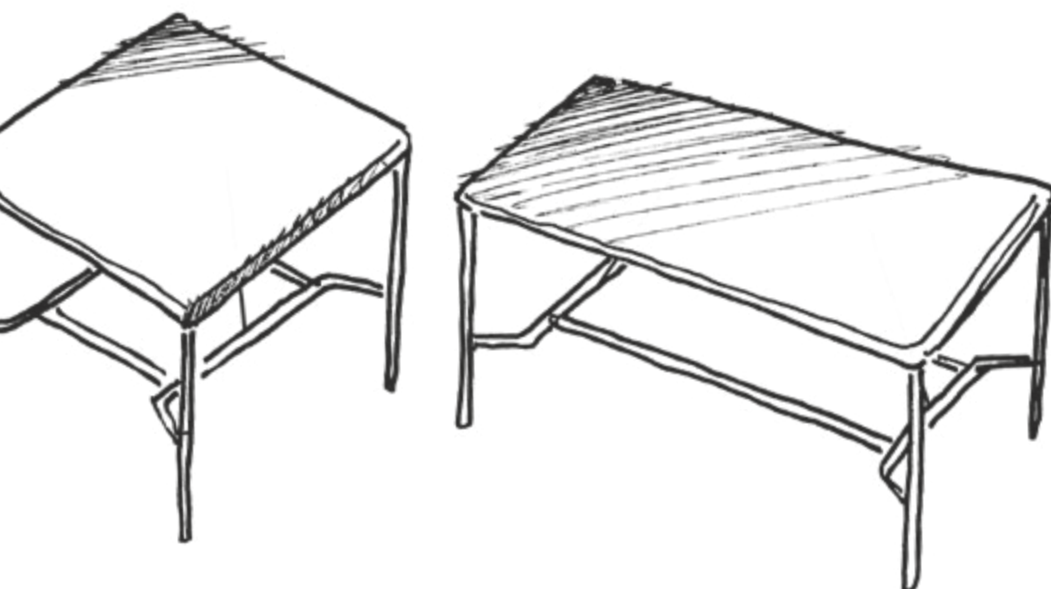



Bench | Bench | Bench | Bench **Fin.** MD, EI
L 300 P 100 H 73,4 cm | W 118 1/8" D 39 3/8" H 28 7/8"







Leggerezza

La struttura è composta da gambe tubolari in metallo verniciato dal diametro di 35 mm, che supportano piani di spessore 18 mm. Gli angoli possono essere sia dritti che raggianti. Nel secondo caso la curva creata va ad armonizzare il punto dove piano e gamba si incontrano.



Bench | Bench | Bench | Bench **Fin.** Ml, EO, DC
L 400 **P** 160 **H** 73,4 cm | **W** 157 1/2" **D** 63" **H** 28 7/8"

Lightweight The structure is composed of tubular legs in painted metal with a diameter of 35 mm (1 3/8"), which support 18 mm (11/16") thick tops. The corners can be either straight or round. In the second case, the curve creates the point where top and leg meet.

Légèreté La structure est composée de pieds tubulaires de 35 mm de diamètre en métal peint, qui soutiennent des plateaux de 18 mm d'épaisseur caractérisés par un rayon sur les quatres angles, qui harmonise le point de jonction des deux éléments.



Ligereza La estructura se compone de patas tubulares de 35 mm de diámetro en metal pintado, que soportan tableros de 18 mm de grosor. Las esquinas pueden ser rectas o redondeadas. En este último caso la curva que se crea armoniza el punto de encuentro entre sobre y pata.



Tavolo | Table | Mesa **Fin.** Mi, EO, EI
L 300 **P** 100 **H** 105 cm | **W** 118 1/8" **D** 39 3/8" **H** 41 3/8"



I piani sono ampi e la palette di finiture disponibili comprende tutti i colori dei melaminici, degli impiallacciati e dei Fenix standard Alea.



Tops are wide and the palette of available finishes includes all colours of Alea standard melamine, veneer and Fenix.

Les plateaux sont larges et la palette des finitions disponibles comprend toutes les couleurs de la mélamine, du placage et du Fenix standard Alea.

Las encimeras son amplias y la paleta de acabados disponibles incluye todos los colores de melamina, chapa de madera y Fenix estándar de Alea.

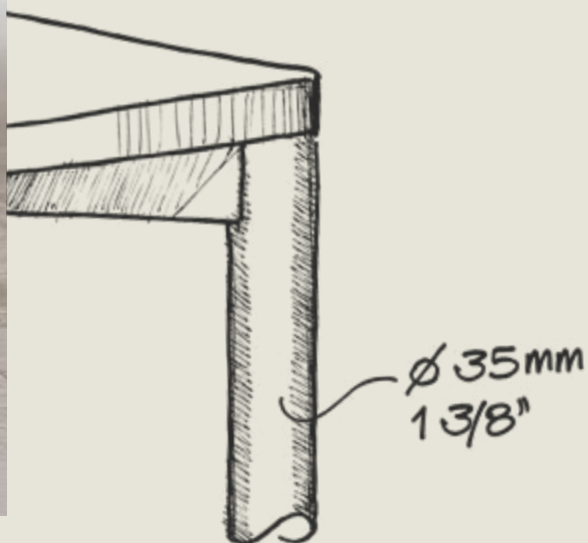



Scrivania | Desk | Bureau | Mesa **Fin.** AK, EZ
L 200 P 100 H 73,4 cm | W 78 3/4" D 39 3/8" H 28 7/8"

Eleganza informale

Rendez-Vous si adatta molto bene ad arredare uffici privati e manageriali. L'impiallacciatura del top impreziosisce tutto il suo design, del quale persiste l'eleganza informale.



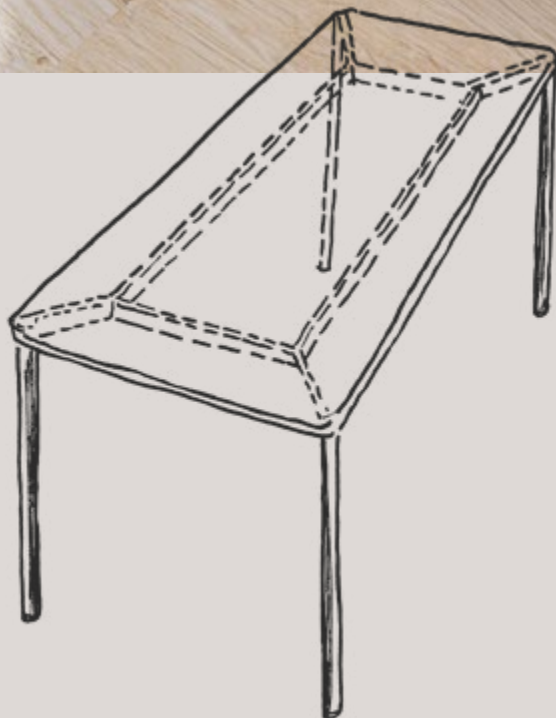

Informal elegance Rendez-Vous is well suited to private and managerial offices. The veneered top enhances the whole design, whose informal elegance persists.

Élégance informelle Rendez-Vous est bien adapté aux bureaux privés et aux bureaux de direction. Le plateau en bois plaqué embellit l'ensemble de son design, dont l'élégance informelle persiste.

Elegancia informal Rendez-Vous se adapta bien a las oficinas privadas y de dirección. La encimera chapada embellece todo su diseño, cuya elegancia informal persiste.



Scrivania | Desk | Bureau | Mesa **Fin.** ML, EN
L 220 P 100 H 73,4 cm | **W** 94 1/2" **D** 47 1/4" **H** 28 7/8"







I tavoli Rendez-Vous arrivano a coprire campate di 300 cm e ben si abbinano ai contenitori di servizio con top dagli angoli arrotondati che si propongono con cassetteria e vano a giorno.

Rendez-Vous tables can cover spans of up to 300 cm (118 1/8") and are well matched to the service units with rounded-corner tops, which are offered with drawers and open compartment.



Scrivania | Desk | Bureau | Mesa **Fin.** MK, EZ
L 200 P 80 H 73,4 cm | W 78 3/4" D 31 1/2" H 28 7/8"
Tavolo | Table | Mesa **Fin.** MK, EZ
L 200 P 120 H 105 cm | W 78 3/4" D 47 1/4" H 41 3/8"

Les tables Rendez-Vous peuvent couvrir une longueur de 300 cm maxi aux meubles de service équipés de tiroirs et compartiments ouverts avec top arrondis.

Las mesas Rendez-Vous pueden cubrir luces de hasta 300 cm y se adaptan bien a los contenedores de servicio con tableros redondeados que vienen con cajones y compartimentos abiertos.



Home office

La semplicità di Rendez-Vous lo rende un elemento facile da inserire all'interno di un contesto domestico. I volumi e il comfort dell'ufficio si trasferiscono a casa.







Rendez-Vous simplicity makes it an easy element to integrate into a domestic context. Office volumes and comfort are transferred at home.

Scrivanía | Desk | Bureau | Mesa **Fin.** NT, EZ
L 200 P 100 H 73,4 cm | W 78 3/4" D 39 3/8" H 28 7/8"

La simplicité de Rendez-Vous en fait un élément facile à intégrer dans un contexte domestique. Les volumes et le confort du bureau sont transférés à la maison.

La sencillez de Rendez-Vous hace que sea un elemento fácil de integrar en un contexto doméstico. Los volúmenes y el confort de la oficina se trasladan al hogar.





FRAMEWORK



Tavolo | Table | Mesa **Fin.** MD, EI, YB
L 160 **P** 80 **H** 73,4 cm | **W** 63" **D** 31 1/2" **H** 28 7/8"
Tavolo | Table | Mesa **Fin.** MD, EI, YB
L 220 **P** 80 **H** 105 cm | **W** 86 5/8" **D** 31 1/2" **H** 41 3/8"







Tavolo | Table | Table | Mesa **Fin.** MT, ET, EO
Ø 150 H 90 cm | Ø 59" H 35 3/8"
Tavolo | Table | Table | Mesa **Fin.** MT, ET, EO
Ø 120 H 105 cm | Ø 47 1/4" H 41 3/8"



Height Tables start at a height of 73,4 cm (28 7/8"), which can be increased to 90 (35 3/8") or 105 cm (41 3/8") thanks to an additional base frame with footrest, which can be painted in a different colour and can be added or removed as required.

Altezze

I tavoli partono da un'altezza di 73,4 cm, che si può aumentare arrivando a 90 o 105 cm. Questo incremento avviene grazie ad una struttura di base addizionale, provvista di poggiapiedi, che si può colorare diversamente rispetto alle gambe e può essere aggiunta o rimossa a piacere.

Hauteur La première hauteur de la table est de 73,4cm, qu'on peut augmenter jusqu'à 90cm ou 105 cm. Ces dernières dimensions peuvent être atteints grâce à une structure additionnelle équipée de repose-pieds, qui peut avoir une finition différente par rapport au pieds fixes. Elle pourra être ajoutée et enlevée à discrétion.

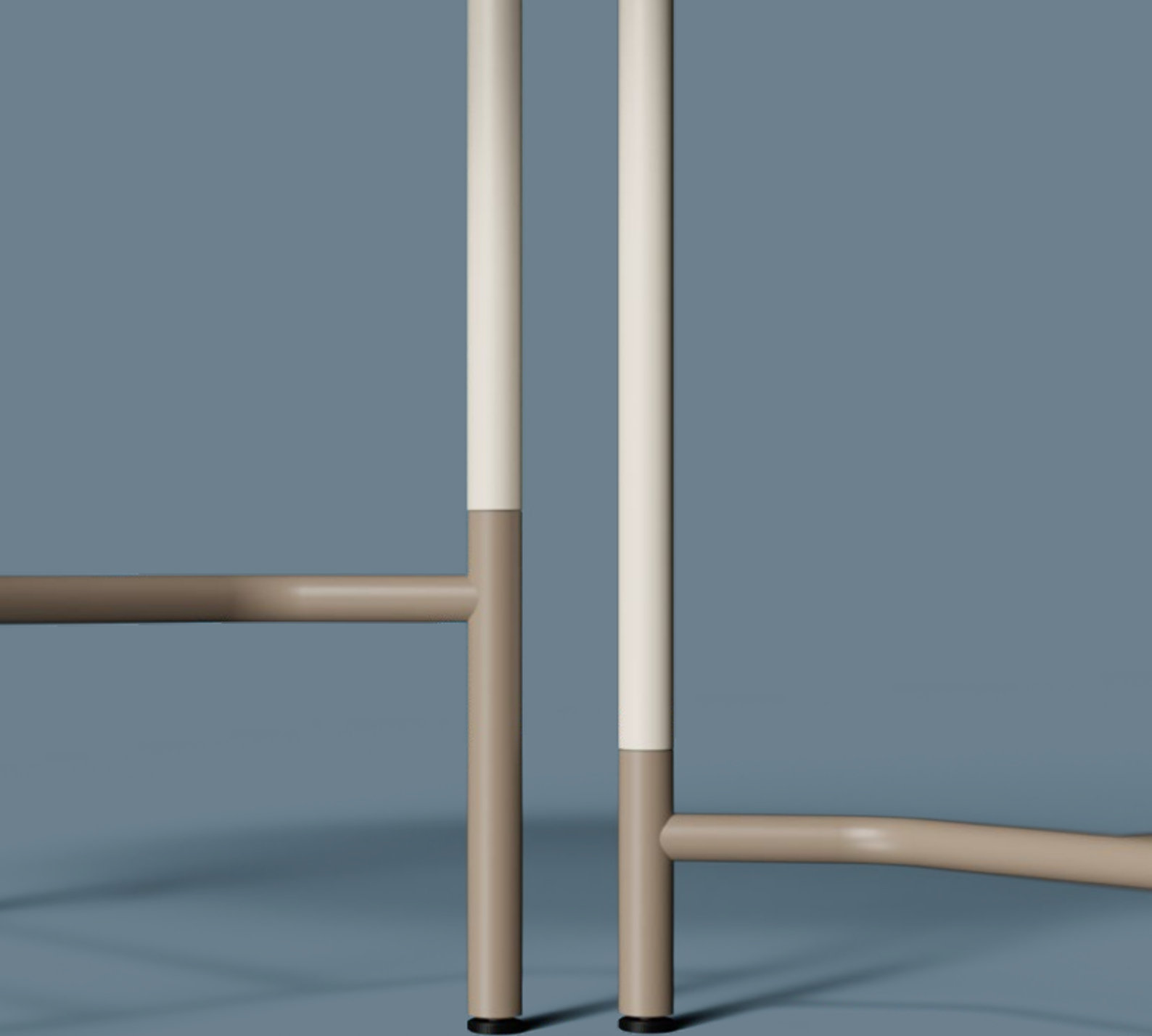

Altura Las mesas parten de una altura de 73,4 cm, que se puede aumentar alcanzando los 90 o 105 cm. Este aumento se produce gracias a una estructura básica adicional, equipada con reposapiés, que se puede colorar de un color diferente de las patas y se puede añadir o eliminar a voluntad.

Opzioni

Per i tavoli H 73,4 e H 105 cm fino a lunghezza 200 cm, è disponibile la versione su ruote. Queste vengono innestate in una struttura apposita così da mantenere invariata l'altezza del piano.

Options For tables H 73,4 (28 7/8") and H 105 cm (41 3/8") up to a length of 200 cm (78 3/4"), a version with castors is available. These are inserted into a special structure so that the height of the table top does not change.

Options Pour les tables H 73,4 et H 105 cm jusqu'à une longueur de 200 cm, une version avec roulettes est disponible. Celles-ci sont insérées dans une structure spéciale de sorte que la hauteur du plateau de la table ne change pas.

Opciones Para mesas H 73,4 y H 105 cm hasta una longitud de 200 cm, hay disponible una versión con ruedas. Éstas se insertan en una estructura especial para que la altura del tablero de la mesa no varíe.

Tavolo | Table | Mesa | **Fin.** MW, EZ, EN
L/P 150 **H** 105 cm | **W/D** 59" **H** 41 3/8"





DALANCED
LAYOUT

#EDES
OFDES

10/19

FRAMEWORK





Forme

I piani dei tavoli Rendez-Vous possono avere forme particolari come quella a 8 (che permette l'accostamento di due diversi colori) oppure quella ovoidale.

Shapes The tops of Rendez-Vous tables can have special shapes such as the 8-shape (which allows the combination of two different colours) or the ovoid shape.

Formes Les plateaux des tables Rendez-Vous peuvent avoir des formes particulières comme la forme en 8 (qui permet de combiner deux couleurs différentes) ou la forme ovoïde.

Formas Los tableros de las mesas Rendez-Vous pueden tener formas especiales, como la forma de 8 (que permite combinar dos colores distintos) o la forma ovalada.



Tavolo | Table | Mesa **Fin** | MT | MJ | ET | EI
L 240 **P** 140 **H** 105 cm | **W** 94 1/2" **D** 55 1/8" **H** 41 3/8"





Tavolo | Table | Mesa **Fin.** ML, EN
L 240 **P** 140 **H** 73,4 cm | **W** 94 1/2" **D** 55 1/8" **H** 28 7/8"

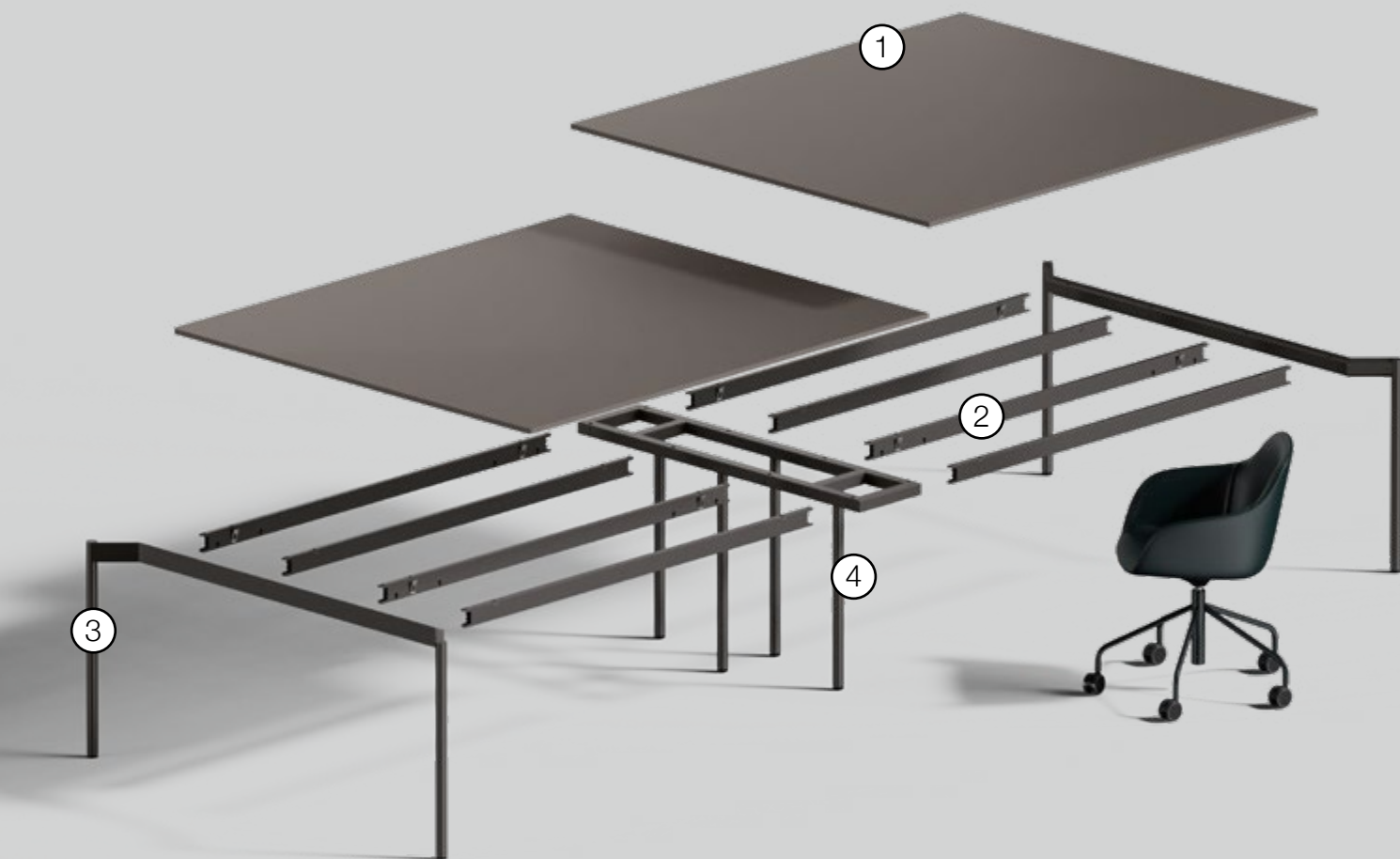

1. Piani per bench fino a 200x160 cm | 2. Longheroni | 3. Gambe terminali | 4. Gamba intermedia per tavoli multipli/bench

1. Bench tops up to 200x160 cm (78 3/4"x 63") | 2. Structural beams | 3. End legs | 4. Intermediate legs for multiple tables/benches

1. Plateaux pour tables jusqu'à 200x160 cm | 2. Poutres | 3. Pieds terminaux | 4. Pied intermédiaire pour tables multiples/bench

1. Sobres para bench hasta 200x160 cm | 2. Travesaños | 3. Patas terminales | 4. Pata intermedia para mesas múltiples/bench



Piani | Desk tops | Plateaux | Sobres

Spessore 1,8 cm | 1,8 cm (3/4") thick | 1,8 cm d'épaisseur | 1,8 cm de espesor

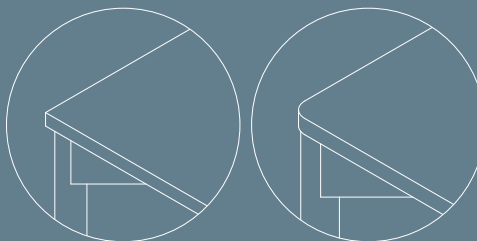

Struttura | Structure | Structure | Estructura

Sezione Ø 3,5 cm | Section Ø 3.5 cm (1 3/8") | Section Ø 3,5 cm | Sección Ø 3,5 cm

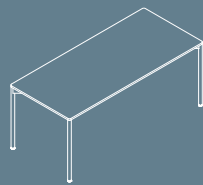

H 73,4 cm
H 28 7/8"

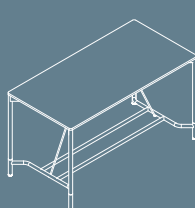

H 90 cm
H 35 3/8"

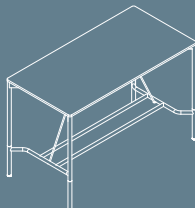

H 105 cm
H 41 3/8"



Ruote disponibili per H 73,4 e H 105 cm fino a L 200 cm

Castors available for H 73.4 (28 7/8") and H 105 cm (41 3/8") up to W 200 cm (78 3/4")

Roulettes disponibles pour H 73,4 et H 105 cm jusqu'à L 200 cm
Ruedas disponibles para H 73,4 y H 105 cm hasta L 200 cm

Scrivanie/tavoli | Desks/tables | Bureaux/tables | Mesas

H 73,4
H 28 7/8"



L 120/140/160 - P 80 cm
W 47 1/4"-55 1/8"-63" - D 31 1/2"

H 73,4/90/105 cm
H 28 7/8"-35 3/8"-41 3/8"

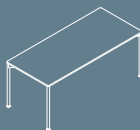

L 180/200/220/260/300 - P 80/100 cm
W 70 7/8"-78 3/4"-86 5/8"-102 3/8"-118 1/8" - D 31 1/2"-39 3/8"

Bench | Bench | Bench | Bench

H 73,4/90/105 cm
H 28 7/8"-35 3/8"-41 3/8"



L 120/140/150/160/180/200 - P 120/150/160 cm
W 47 1/4"-55 1/8"-59"-63"-70 7/8"-78 3/4" - D 47 1/4"-59"-63"

Bench/tavoli multipli | Bench/multiple tables | Bench/tables multiples | Bench/múltiples mesas

H 73,4/90/105 cm
H 28 7/8"-35 3/8"-41 3/8"

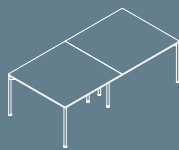

L 240/280/320/360/400 - P 80/100/120/150/160 cm
W 94 1/2"-110 1/4"-126"-141 3/4"-157 1/2" - D 31 1/2"-39 3/8"-47 1/4"-59"-63"

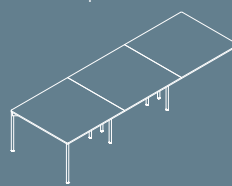

L 360/420/480/540/600 - P 80/100/120/150/160 cm
W 141 3/4"-165 3/8"-189"-212 5/8"-236 1/4" - D 31 1/2"-39 3/8"-47 1/4"-59"-63"

Tavoli riunione | Meeting tables | Tables de réunion | Mesas de juntas

H 73,4/90/105 cm
H 28 7/8"-35 3/8"-41 3/8"



Ø 120/150 cm
Ø 47 1/4"-59"

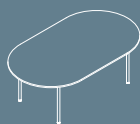

L 210/240 - P 120/140 cm
W 82 5/8"-94 1/2" - D 47 1/4"-55 1/8"



Finiture | Finishes | Finitions | Acabados

MEL

Melaminico

Melamine | Mélaminé | Melaminico

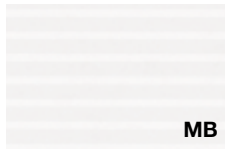

Bianco rigato
Rippled effect white
Blanc avec rayures en sérigraphie
Blanco rayado

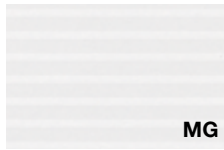

Grigio rigato
Rippled effect grey
Gris avec rayures en sérigraphie
Gris rayado



Nichel
Nickel
Nickel
Níquel



Cacao
Cocoa
Cacao
Cacao



Bianco
White
Blanc
Blanco

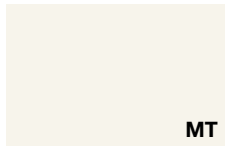

Talco
Talco
Talco
Talco



Ocra
Ochre
Ocre
Ocre



Terracotta
Terracotta
Terre cuite
Terracota



Safari
Safari
Safari
Safari



Noisette
Noisette
Noisette
Noisette



Verde
Green
Vert
Verde



Nero
Black
Noir
Negro



Blu notte
Night blue
Bleu nuit
Azul noche

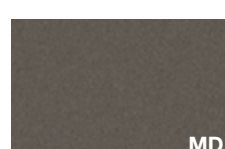

Ardesia
Ardesia
Ardesia
Pizarra

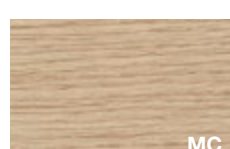

Rovere chiaro
Light oak
Chêne clair
Roble claro



Rovere americano
American oak
Chêne américain
Roble americano



Rovere grigio
Grey oak
Chêne gris
Roble gris



Rovere moro
Dark oak
Chêne foncé
Roble oscuro



Noce Canaletto
Canaletto Walnut
Noyer Canaletto
Nogal Canaletto

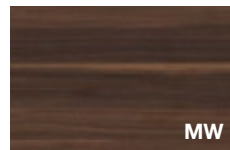

Noce scuro
Dark walnut
Noyer foncé
Nogal oscuro

LGN

Legno

Wood | Bois | Madera



Rovere chiaro
Light oak
Chêne clair
Roble claro



Rovere grigio fumo
Smoke grey oak
Chêne gris de fumée
Roble gris humo



Rovere moro
Dark oak
Chêne foncé
Roble oscuro

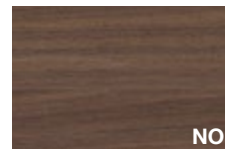

Noce Canaletto
Canaletto Walnut
Noyer Canaletto
Nogal Canaletto



Ebano Silver
Silver ebony
Ebony Silver
Ebano plata

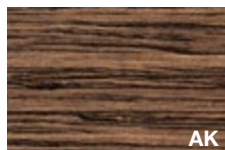

Ebano Makassar
Makassar ebony
Ebony Makassar
Ebano Makassar



Noce termocotto
Heat-treated walnut
Noyer thermo traité
Nogal termotratado

FNX

Fenix

Fenix | Fenix | Fenix

TOP

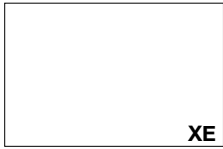

Bianco
White
Blanc
Blanco



Beige Arizona
Arizona beige
Beige Arizona
Beige Arizona



Blu Fes
Fes blue
Bleu Fes
Azul Fes



Grigio Bromo
Bromo grey
Gris Bromo
Gris Bromo



Verde Comodoro
Comodoro green
Vert Comodoro
Verde Comodoro

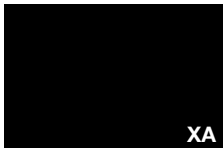

Nero
Black
Noir
Negro

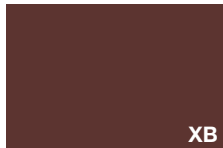

Rosso Jaipur
Jaipur red
Rouge Jaipur
Rojo Jaipur

TES

Tessuto

Fabric | Tissu | Tejido

SCR



Beige
Beige
Beige
Beige

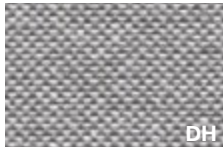

Grigio chiaro
Light grey
Gris clair
Gris claro



Ardesia
Ardesia
Ardesia
Pizarra



Blu avio
Avio blue
Bleu avio
Azul avio



Acquamarina
Aquamarine
Aigue-marine
Aguamarina



Verde primavera
Spring green
Vert printemps
Verde primavera

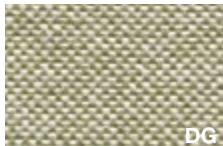

Salvia
Sage
Sauge
Salvia



Arancio
Orange
Orange
Naranja



Corallo
Coral
Corail
Coral

EPX

Epossidico

Epoxy | Époxy | Epoxi



EB

Bianco

White
Blanc
Blanco

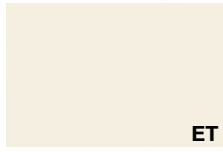

ET

Talco

Talco
Talco
Talco



EG

Grigio

Grey
Gris
Gris



YD

Beige Arizona

Arizona beige
Beige Arizona
Beige Arizona



EO

Noisette

Noisette
Noisette
Noisette



EK

Safari

Safari
Safari
Safari



EE

Rame

Copper
Cuivre
Cobre



EH

Terracotta

Terracotta
Terre cuite
Terracota



YB

Rosso Jaipur

Jaipur red
Rouge Jaipur
Rojo Jaipur



EZ

Bronzo

Bronze
Bronze
Bronze



YQ

Blu notte

Night blue
Bleu nuit
Azul noche



YC

Grigio Bromo

Bromo grey
Gris Bromo
Gris Bromo



EI

Ardesia

Ardesia
Ardesia
Pizarra



YV

Verde Comodoro

Comodoro green
Vert Comodoro
Verde Comodoro

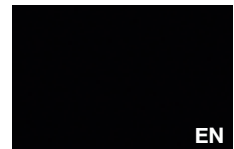

EN

Nero

Black
Noir
Negro

Applicazioni finiture

Finish application | Application finitions | Aplicacion acabados



Top
Piano
Plateau
Sobre



Screen
Screen
Écran
Panel



Struttura
Structure
Structure
Structura

Le finiture contenute nella stampa sono puramente indicative e non sono di riferimento per le finiture del prodotto

Due to the printing process, finishes shown in this document are for illustration only. The finish on the final item may differ slightly from the printed illustration

Les finitions contenues dans l'impression sont purement indicatives et ne sont pas pertinentes pour les finitions du produit

Los acabados contenidos en la impresión son puramente indicativos y no son de referencia para los suministros del producto

Ambiente e sicurezza | Environment and safety | Environnement et sécurité | Medio ambiente y seguridad

Ecologia: Alea utilizza per i suoi prodotti e i suoi imballi materiali facilmente separabili e riciclabili. (Immagine 1)

Catena Di Custodia COC: Alea si impegna ad utilizzare materiali legnosi certificati FSC® e pannelli a base di legno con certificazione CARB2.

I pannelli CARB2 presentano un rilascio di formaldeide inferiore rispetto al pannello E1 comunemente utilizzato (classe E1 secondo il DM 10/10/2008).

I prodotti certificati FSC® (License Code FSC-C118323) sono disponibili su richiesta: contattate i nostri uffici per maggiori informazioni. (Immagine 2)

LEED: Gli arredi di Alea possono contribuire al conseguimento del punteggio di certificazione LEED per i crediti indicati nei product badge. (Immagine 3)

Sistemi di Gestione certificati ISO 9001, ISO 14001, ISO 45001: Alea è attivamente impegnata nel raggiungere standard elevati di qualità e responsabilità attraverso l'adozione di sistemi di gestione certificati ISO per garantire prodotti e servizi di elevata qualità, in grado di soddisfare le aspettative dei clienti, di assicurare un ambiente di lavoro sicuro e di monitorare regolarmente l'impatto ambientale delle nostre attività. (Immagine 4)

Attestazione di prodotto: I prodotti Alea sono stati sottoposti a prove prestazionali presso laboratori di prova accreditati.

Copia dei rapporti di prova o delle attestazioni di conformità sono disponibili su richiesta. (Immagine 5)

Eco-friendly: Alea uses easily separable and recyclable materials for its products and packaging. (Image 1)

Chain of Custody (COC): Alea is committed to using FSC® certified wood materials and CARB2-certified wood-based panels. CARB2 panels have lower formaldehyde emissions compared to the commonly used E1 panels (class E1 according to the DM 10/10/2008). FSC® certified products (License Code FSC-C118323) are available upon request: please contact our offices for more information. (Image 2)

LEED: The A65 system can contribute to obtaining LEED certification points for the credits indicated in the product badges. (Image 3)

ISO 9001, ISO 14001, ISO 45001 Certified Management Systems: Alea is actively committed to achieving high standards of quality and responsibility through the adoption of ISO certified management systems to ensure high-quality products and services that meet customer expectations, provide a safe working environment, and regularly monitor the environmental impact of our activities. (Image 4)

Product Certification: Alea products have undergone performance tests by accredited testing laboratories. Copies of test reports or certificates of conformity are available upon request. (Image 5)



Ambiente e sicurezza | Environment and safety | Environnement et sécurité | Medio ambiente y seguridad

Écologie: Alea utilise pour ses produits et ses emballages des matériaux facilement séparables et recyclables. (Image 1)

Chaîne de contrôle COC: Alea a à cœur d'utiliser des matériaux en bois certifiés FSC® et des panneaux à base de bois avec la certification CARB2.

Les panneaux CARB2 présentent une émission de formaldéhyde inférieure à celle des panneaux E1 couramment utilisés (classe E1 selon le DM 10/10/2008). Les produits certifiés FSC® (Code de licence FSC-C118323) sont disponibles sur demande : veuillez contacter nos bureaux pour plus d'informations. (Image 2)

LEED: Le système A65 peut contribuer à l'obtention des points de certification LEED pour les crédits indiqués dans les badges produits. (Image 3)

Systèmes de gestion certifiés ISO 9001, ISO 14001, ISO 45001: Alea s'engage activement à atteindre des normes élevées de qualité et de responsabilité à travers l'adoption de systèmes de gestion certifiés ISO pour garantir des produits et services de haute qualité, répondre aux attentes des clients, assurer un environnement de travail sûr et surveiller régulièrement l'impact environnemental de nos activités. (Image 4)

Attestation de produit: Les produits Alea ont été soumis à des tests de performance dans des laboratoires d'essais accrédités. Des copies des rapports de tests ou des certificats de conformité sont disponibles sur demande. (Image 5)

Ecología: Alea utiliza para sus productos y embalajes materiales fácilmente separables y reciclables. (Imagen 1)

Cadena de Custodia COC: Alea se compromete a utilizar materiales de madera certificados por FSC® y paneles a base de madera con certificación CARB2.

Los paneles CARB2 presentan una emisión de formaldehído inferior en comparación con los paneles E1 comúnmente utilizados (clase E1 según el DM 10/10/2008). Los productos certificados por FSC® (Código de Licencia FSC-C118323) están disponibles bajo solicitud: por favor contacte a nuestras oficinas para más información. (Imagen 2)

LEED: El sistema A65 puede contribuir a la consecución de la puntuación de certificación LEED para los créditos indicados en los product badges. (Imagen 3)

Sistemas de Gestión Certificados ISO 9001, ISO 14001, ISO 45001: Alea está comprometida activamente en alcanzar altos estándares de calidad y responsabilidad mediante la adopción de sistemas de gestión certificados por ISO para garantizar productos y servicios de alta calidad, que cumplen con las expectativas de los clientes, aseguran un entorno de trabajo seguro y monitorean regularmente el impacto ambiental de nuestras actividades. (Imagen 4)

Certificación de Producto: Los productos Alea han sido sometidos a pruebas de rendimiento en laboratorios acreditados. Las copias de los informes de prueba o los certificados de conformidad están disponibles bajo solicitud. (Imagen 5)



1.



2.



3.



4.



5.

Concept & design

Alea marketing + communication

Art director

Mirto Antonel

Product design

Mirto Antonel

Si ringrazia M.artedesign

martedesign.it

AG/CACD/AF

Le immagini dei prodotti visibili all'interno di questo catalogo sono inserite a scopo puramente indicativo

The images of the products visible in this catalogue are included for information purposes only
Les images des produits visibles dans ce catalogue sont incluses à titre informatif uniquement
Las imágenes de los productos visibles en este catálogo se incluyen sólo con fines informativos

alea
aleaoffice.com



GLOBAL HEADQUARTERS AND SHOWROOM : Via Col de Rust, 19 - 33070 Sarone (PN) - Italia : Tel ++39 0434 777 333
email: info@aleaoffice.com **PARIS SHOWROOM** : 176 Avenue Charles de Gaulle 92200, Neuilly-sur-Seine - France **NORTH AMERICAN
HEADQUARTERS** : Midtown 2, 3449 NE 1st Avenue L-32, Miami, FL 33137 - USA : Tel ++1 305 470 1200 - email: info@alea-usa.com
ALEA UK OFFICE AND SHOWROOM : 50-54 Clerkenwell Road, London EC1M 5PS - email: info@aleaoffice.com