

# alea

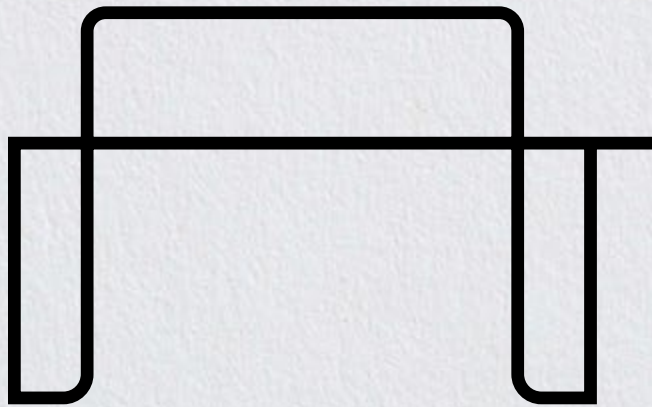

# Itube

---

workstations



Selezione Compasso d'Oro

## Segno

Itube è una collezione operativa dove l'estetica diventa funzione.

La sua struttura è definita da un segno continuo che interseca e sostiene il piano.

Itube is a collection where aesthetics becomes function. Its structure is a continuous sign that intersects and supports the top.

Itube est une collection où l'esthétique devient fonction. Sa structure est un signe continu qui s'entrecroise et soutient le sommet.

Itube es una colección en la que la estética se convierte en función. Su estructura es un signo continuo que se cruza y sostiene la parte superior.

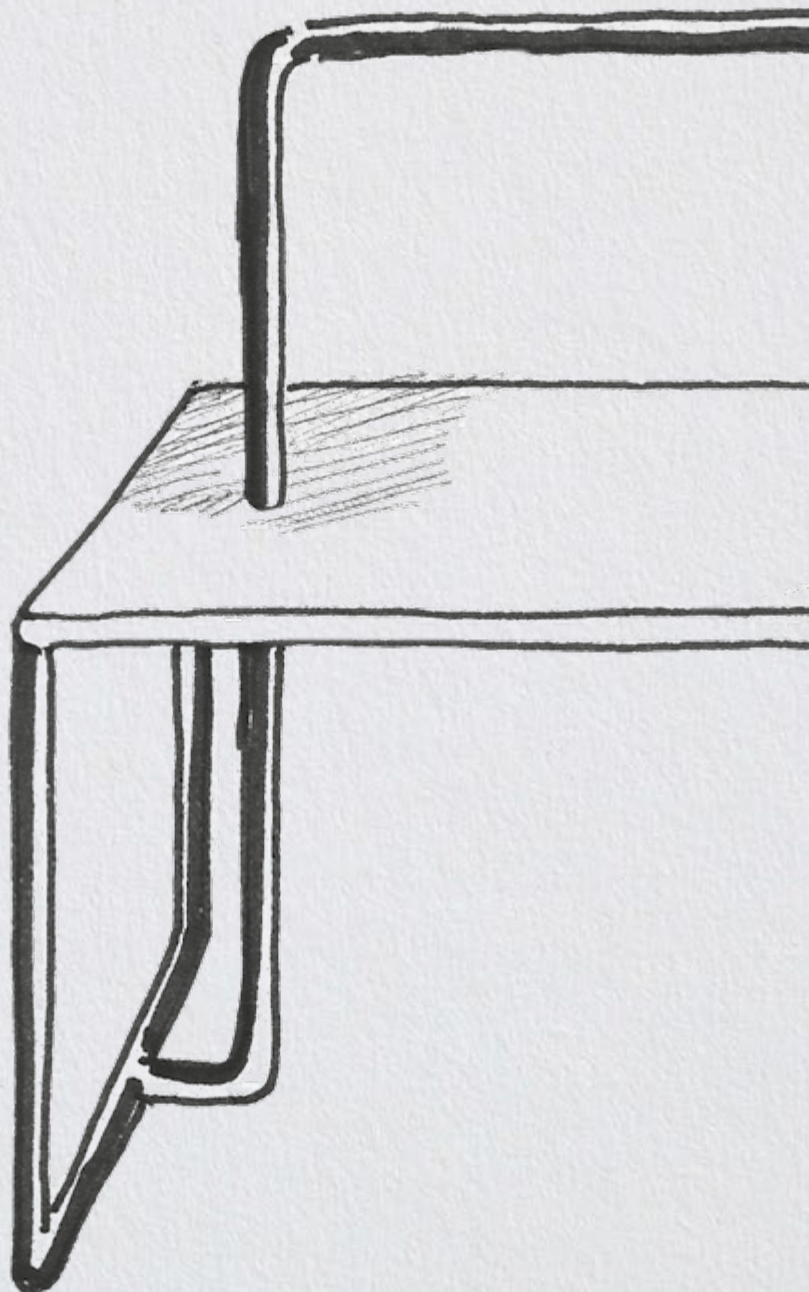

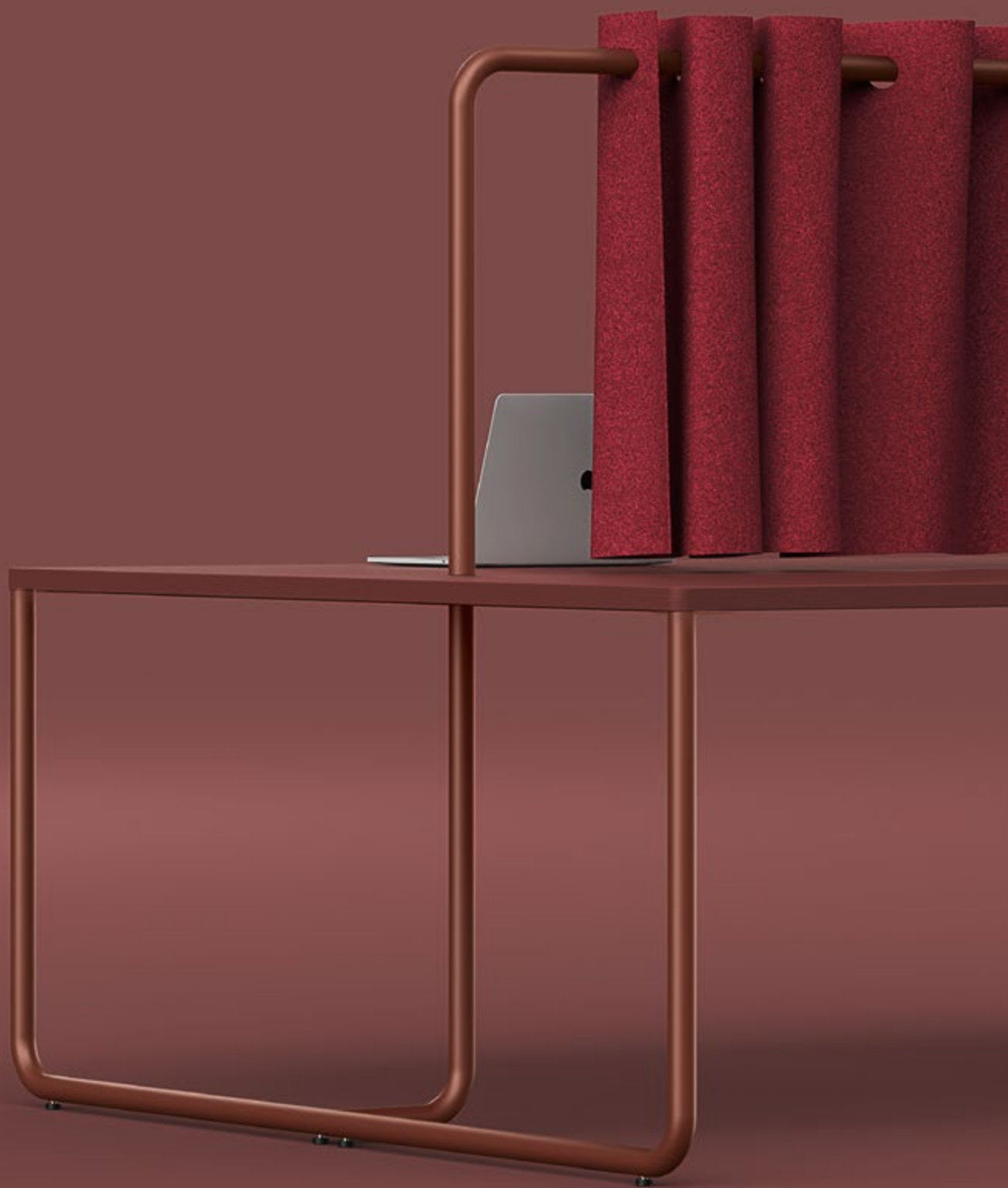



---

## Caratteristiche

Il profilo tubolare in Itube è di diametro 35 mm e le sue gambe curvilinee rendono armoniosa la struttura.



**Bench** | Bench | Bench | Bench **Fin.** MN, EB, XE  
**L** 400 **P** 160 **H** 73,4 cm | **W** 157 1/2" **D** 63" **H** 29"



**Features** The tubular profile in Itube has a diameter of 35 mm (1 3/8") and the curved legs create a harmonious design.

**Caractéristiques** La forme tubulaire qui constitue Itube a un diamètre de 35 mm et ses pieds ont des rayons à chaque changement de direction de la structure.

**Características** El perfil tubolar de Itube es de 35 mm de diámetro y sus patas curvilíneas hacen armoniosa la estructura.





## Funzionalità

Itube è stato pensato con diverse tipologie di accessori: mensole rettangolari o dalla forma organica, portapiante e vani portaoggetti incassati tra i semipiani.



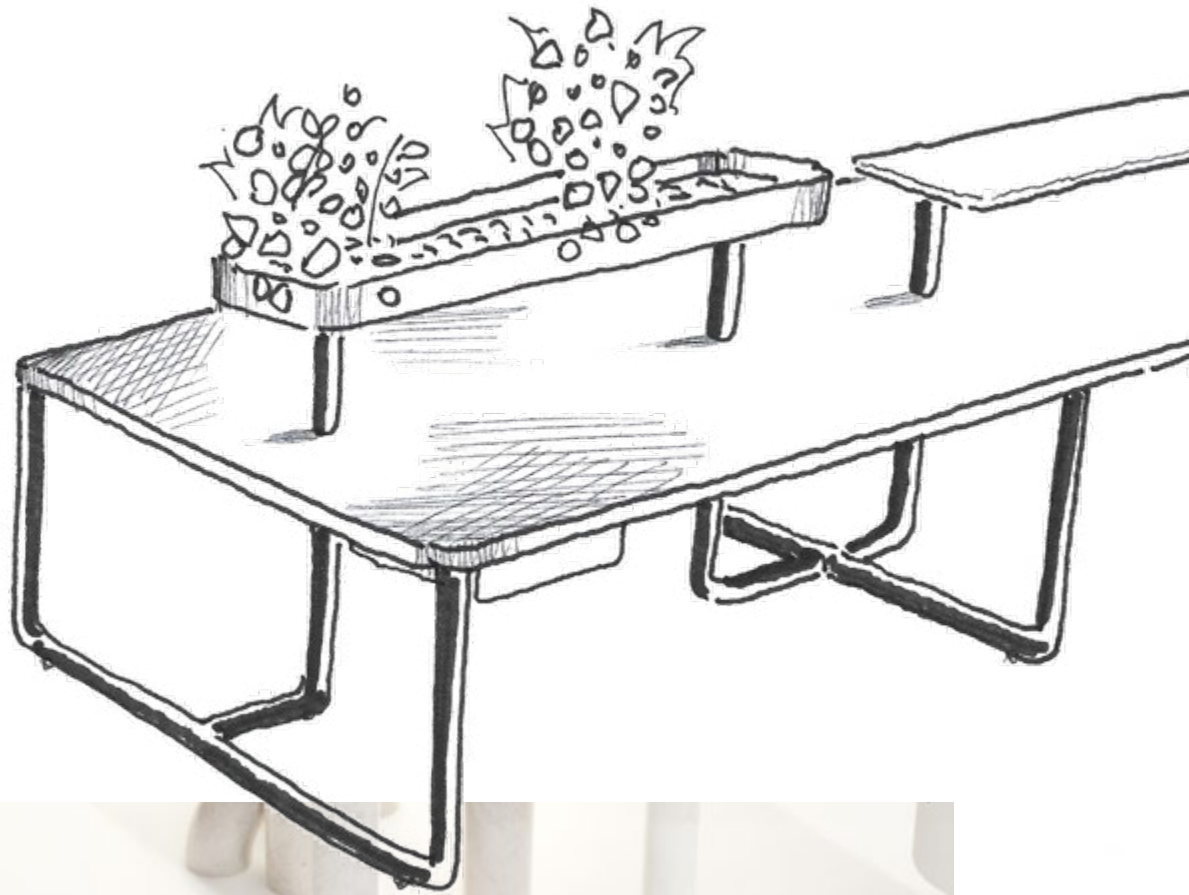

**Bench** | Bench | Bench | Bench **Fin.** XB, YB  
**L** 360 **P** 120 **H** 73,4 cm | **W** 141 3/4" **D** 47 1/4" **H** 29"

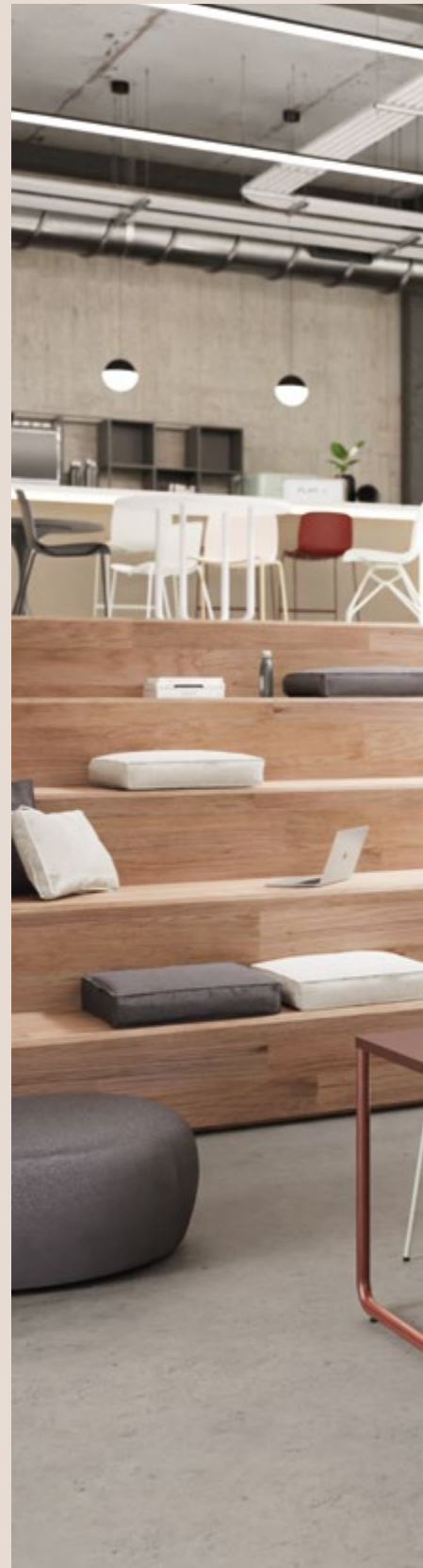



**Functionality** Itube has been designed with three types of accessories: rectangular or leaf shaped shelves, plant holders and built-in compartments.

**Fonctionnalité** Itube a été conçu avec trois types d'accessoires : des étagères rectangulaires ou de forme organique, des porte-plantes et des bacs encastrés entre demi-plateaux.

**Funcionalidad** Itube se ha diseñado con tres tipos de accesorios: estantes rectangulares o de forma orgánica, jardineras y bandejas portaobjetos empotradas entre los sobres.



**Bench** | Bench | Bench | Bench **Fin.** MK, XB, YB, DC  
**L** 180 **P** 160 **H** 73,4 cm | **W** 70 7/8" **D** 63" **H** 29"



---

## Altezze

Il tubo che attraversa il bench  
soprapiano è disponibile in due  
altezze: 69,4 cm e 40 cm.









**Heights** The tube that crosses the bench above the table top is provided in two different heights: 69,4 cm high (27 3/8") and 40 cm high (15 3/4").

**Hauteurs** Le tube qui traverse le bench au-dessus du plateau est fourni en deux hauteurs différentes : 69,4 cm et 40 cm.

**Alturas** El tubo que atraviesa la encimera, sobre mesa, està disponible en dos alturas: 69,4 cm y 40 cm.





**Bench** | Bench | Bench | Bench **Fin.** ML, EN, DI  
L 280 P 160 H 73,4 cm | W 110 1/4" D 63" H 29"



Bench | Bench | Bench | Bench **Fin.** ML, EN  
L 280 P 160 H 73,4 cm | W 110 1/4" D 63" H 29"



## Carattere

Itube diventa funky nelle sue declinazioni più decise. Perfetto per ambienti coworking dal taglio fresco e dinamico.



**Personality** Itube gets funky in its most unexpected proposal. Perfect for fresh and dynamic coworking environments.

**Caractère** Itube devient funky dans ses déclinaisons les plus fortes. Parfait pour les environnements de coworking frais et dynamiques.

**Personalidad** Itube se pone jocoso en sus declinaciones más extravagantes. Perfecto para entornos de coworking frescos y dinámicos.



**Bench** | Bench | Bench | Bench **Fin.** XV, YV  
L 600 P 150 H 73,4 cm | W 236 1/4" D 59" H 29"





**Bench** | Bench | Bench | Bench **Fin.** MK, EK, FF  
**L** 400 **P** 160 **H** 73,4 cm | **W** 157 1/2" **D** 63" **H** 29"



## Esclusivo

Itube introduce per la prima volta la tenda come elemento dinamico. Può anche essere utilizzata per separare postazioni di lavoro, cosicché il lavoratore possa definire il proprio spazio.

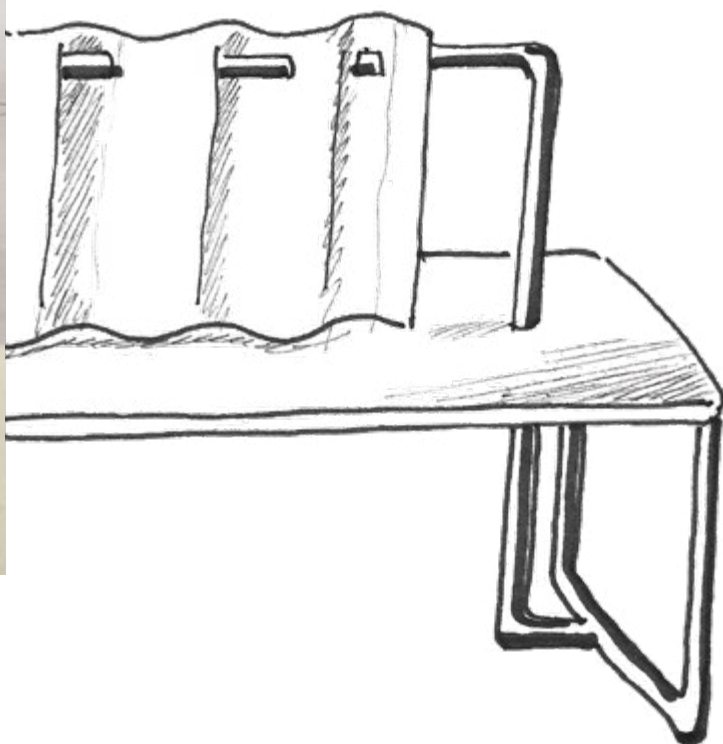





**Exclusive** Itube introduces the curtain for the first time as a dynamic element. Used to separate workstations, it enables users to define their own space.

**Exclusif** Itube présente pour la première fois le rideau comme un élément dynamique. Il peut séparer les postes de travail ou non, créant ainsi une interaction avec le travailleur dans la définition de son espace.

**Exclusivo** Itube introduce por primera vez la cortina como elemento dinámico. También puede utilizarse para separar puestos de trabajo, de modo que el trabajador pueda definir su propio espacio.

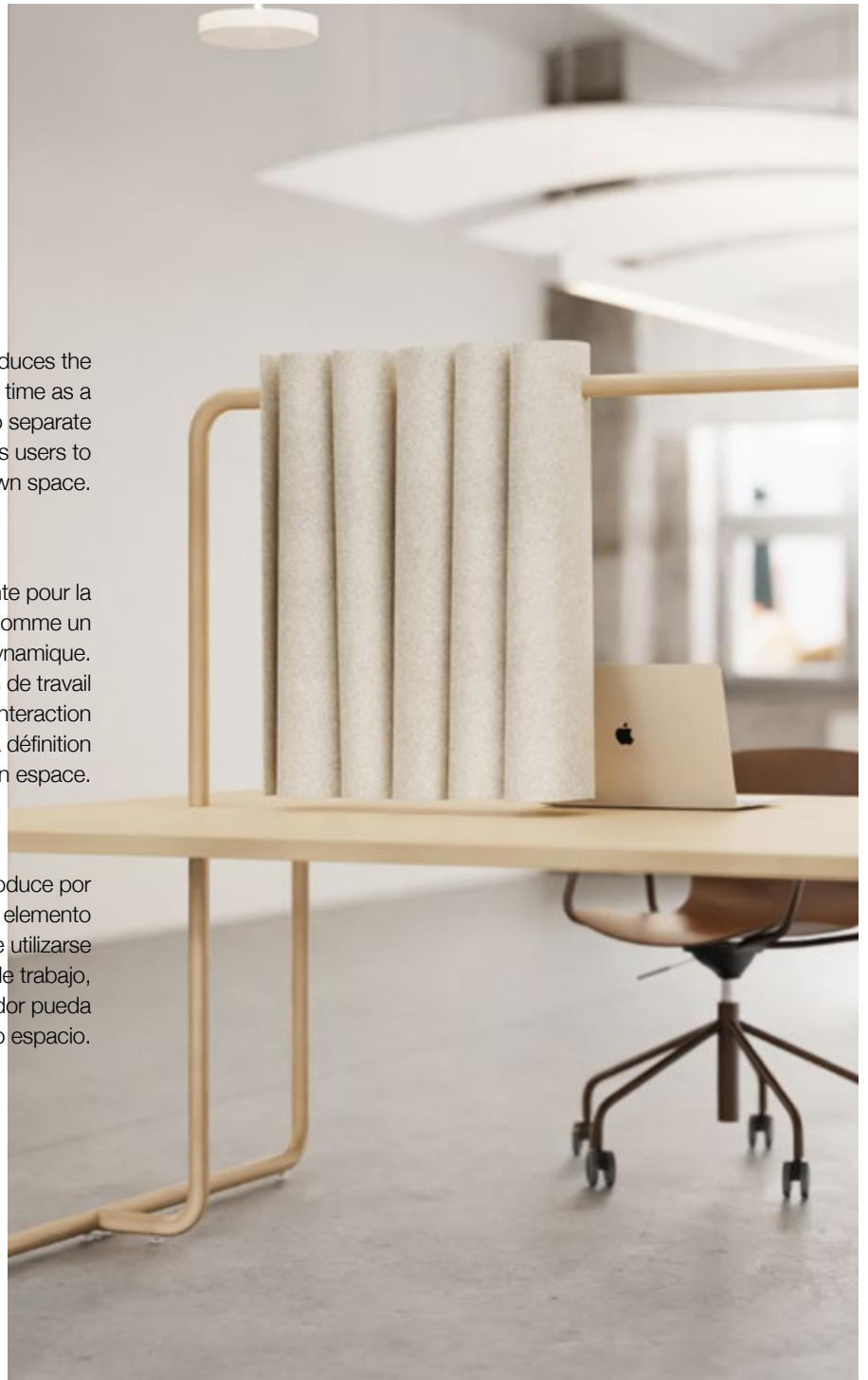

---

## Lineare

Una delle declinazioni della collezione è il bench lineare. Si prevede che gli utenti si posizionino da un lato soltanto e questo rende il bench particolarmente adatto ad essere collocato fronte finestra o parete. Si addice ad ambienti universitari e biblioteche.

**Linear** One of the proposals of this collection is the linear bench. Users can sit on the same side, making it suitable near windows or walls, and especially in university environments and libraries.

**Linéaire** L'une des déclinaisons de la collection est le bench linéaire. Sa particularité réside dans le fait qu'il accueille l'utilisateur d'un seul côté, ce qui le rend particulièrement adapté pour se positionner en face d'une fenêtre ou à un mur, et il convient également aux environnements universitaires et aux bibliothèques.

**Lineal** Una de las declinaciones de la colección es el bench lineal. Está previsto que los usuarios se sienten en un sólo lado y esto hace que el bench sea especialmente adecuado para colocarlo frente a una ventana o una pared. Es apto para entornos universitarios y bibliotecas.

**Bench** | Bench | Bench | Bench **Fin.** XC, YC  
L 360 P 90 H 73,4 cm | W 141 3/4" D 35 3/8" H 29"









**Tavolo** | Table | Mesa **Fin.** MZ, EZ  
**L 280 P 120 H 73,4 cm | W 110 1/4" D 47 1/4" H 29"**



## Tavoli

Le curve che caratterizzano la struttura si riflettono anche nei piani e si ritrovano nelle forme ovoidale, rettangolare e tonda.



**Tavolo** | Table | Mesa. **Fin.** MN, EB  
L 280 P 120 H 73,4 cm | W 110 1/4" D 47 1/4" H 29"

**Tables** The curves that characterise the structure also define the rectangular, oval and round table tops.

**Tables** Itube a été conçu avec trois types d'accessoires: des étagères rectangulaires ou de forme organique, des porte-plantes et des bacs encastrés entre demi-plateaux.

**Tablas** Las curvas que caracterizan la estructura se reflejan en los sobres también y se encuentran en las formas ovalizada, rectangular y redonda.









**Tavolo** | Table | Mesa **Fin.** MN, EB / XB, YB  
Ø 120 H 73,4 cm | Ø 47 1/4" H 29"

## Scrivanie

La scrivania completa l'offerta della collezione Itube.

Le sue linee leggere e funky contribuiscono ad alleggerire l'atmosfera circostante.

**Executive** The desk completes the Itube collection offer.

With its light, unique lines, it lightens the tone of the workspace environment.





**Scrivania** | Desk | Bureau | Mesa **Fin.** XV, YV  
L 200 P 90 H 73,4 cm | W 78 3/4" D 35 3/8" H 29"

**Dattilo** | Return | Retour | Ala **Fin.** XV, YV  
L 120 P 60 H 73,4 cm | W 47 1/4" D 23 5/8" H 29"

**Bureaux** Le bureau complète l'offre de la collection Itube.

Avec ses lignes légères et funky, il allège le ton de l'espace de travail.

**Escritorio** El escritorio completa la oferta de la colección Itube.

Sus líneas ligeras y extravagantes contribuyen a aligerar el ambiente.

## Composizioni

Itube prevede l'aggiunta anche di screen puntaspilli (spessore 30 mm) frontali, direttamente fissati al piano, e laterali, in appoggio e per questo facilmente removibili.





**Compositions** Itube also includes frontal pinnable screens (30 mm, 1 3/16", thick), fixed onto the desktop, and lateral movable screens supported by round metal bases.

**Compositions** Itube prévoit l'ajoute d'écrans frontaux punaisables (ép. 30 mm), directement fixés au plateau, et latéraux en appui donc facilement amovibles.

**Composiciones** Itube también prevé la adición de paneles separadores pinchables (30 mm de espesor) frontales, que se fijan directamente al sobre, y laterales que se apoyan y desmontan fácilmente.

**Bench 2P** | Bench 2P | Bench 2P | Bench 2P **Fin.** MK, EK, DC  
**L** 200 **P** 160 **H** 73,4 cm | **W** 78 3/4" **D** 63" **H** 29"

**Bench 4P** | Bench 4P | Bench 4P | Bench 4P **Fin.** MK, EK, DC  
**L** 400 **P** 160 **H** 73,4 cm | **W** 157 1/2" **D** 63" **H** 29"

**Accessori laterali**  
Side accessories  
Accessoires latéraux  
Accesorios laterales

**Altezza 69,4 cm**  
69,4 cm (27 3/8") height  
Hauteur 69,4 cm  
Altura 69,4 cm

**Spessore 1,8 cm**  
1,8 cm (3/4") thick  
1,8 cm d'épaisseur  
1,8 cm de espesor

**Mensola frontale**  
Frontal shelf  
Etagère frontal  
Estante frontal

**Vasca**  
Organizer  
Bac  
Jardinera

**Altezza 20 cm e 30 cm**  
20 cm (7 7/8") or 30 cm height (11 7/8")  
Hauteur 20 cm et 30 cm  
Altura 20 cm y 30 cm

**Altezza 40 cm**  
40 cm (15 3/4") height  
Hauteur 40 cm  
Altura 40 cm

**Spessore 3 cm**  
3 cm (1 1/4") thick  
3 cm d'épaisseur  
3 cm de espesor

**Spessore 1,8 cm**  
1,8 cm (3/4") thick  
1,8 cm d'épaisseur  
1,8 cm de espesor

**Cassetto sottopiano**  
Hanged drawer  
Tirette sous plateau  
Cajón debajo del sobre

**Carter magnetico**  
Magnetic cable duct  
Goulotte verticale  
aimantee  
Columna magnética  
de cableado

 **LED opzionale** / LED light optional / Lumière à LED optionnelle / Luz LED opcional.



**Piani** | Desk tops | Plateaux | Sobres  
**Spessore 3 cm** | 3 cm (1 1/4") thick | 3 cm d'épaisseur | 3 cm de espesor





**Piani** | Desk tops | Plateaux | Sobres

Spessore 3 cm | 3 cm (1 1/4") thick | 3 cm d'épaisseur | 3 cm de espesor

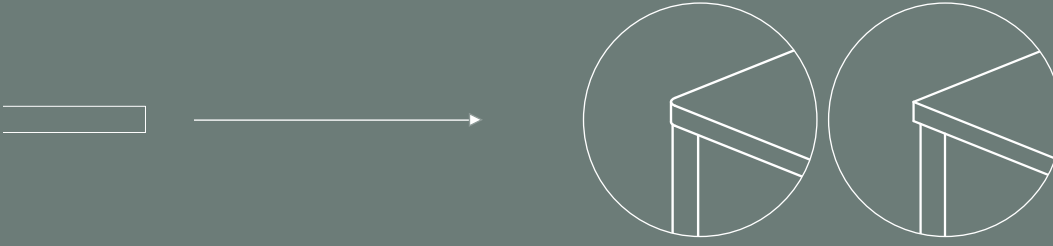

**Scrivanie/tavoli** | Desks/tables | Bureaux/tables | Escritorios/Mesas

**Dattilo** | Return | Retours | Alas

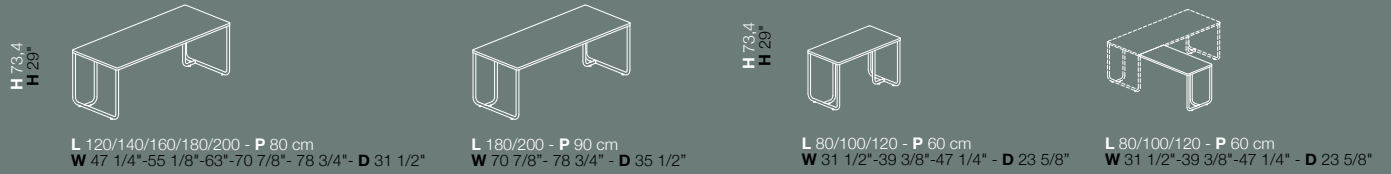

**Bench lineare** | Line bench | Bench linéaire | Mesas colectivas

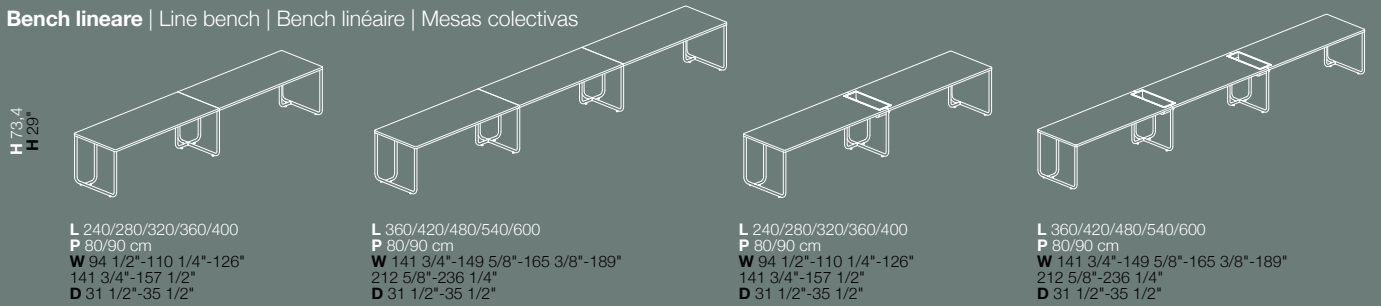

**Bench** | Bench | Bench | Bench

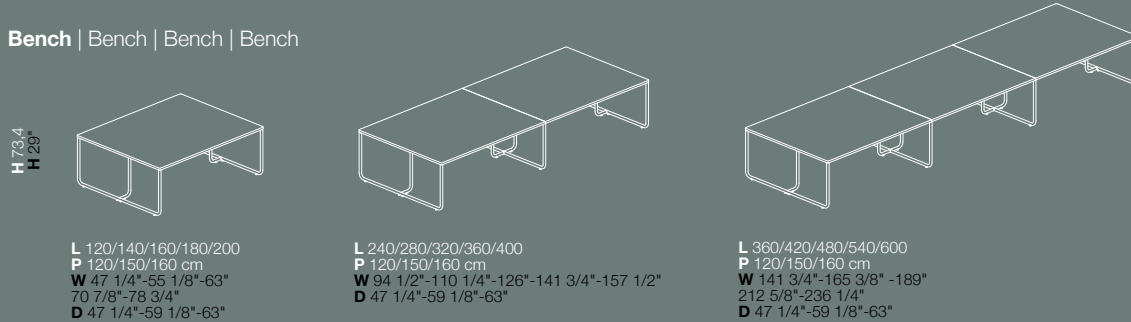

**Bench** | Bench | Bench | Bench

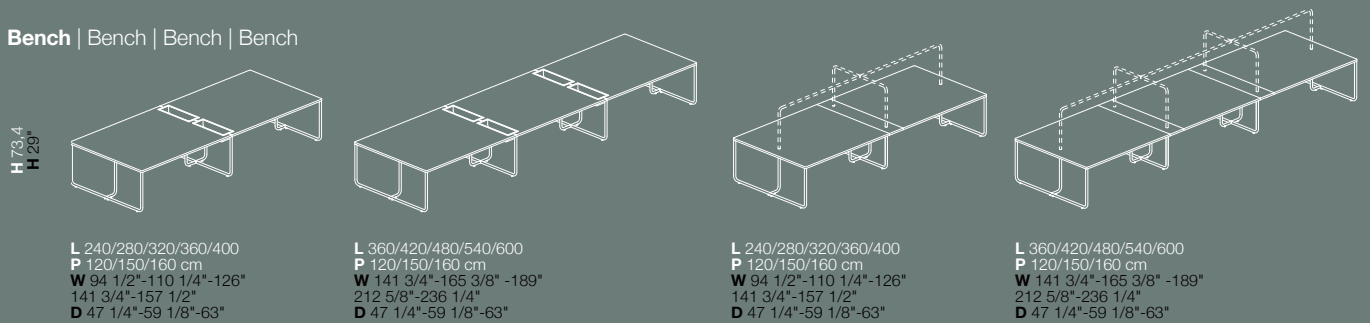

**Tavoli riunione** | Meeting tables | Tables de réunion | Mesas de juntas

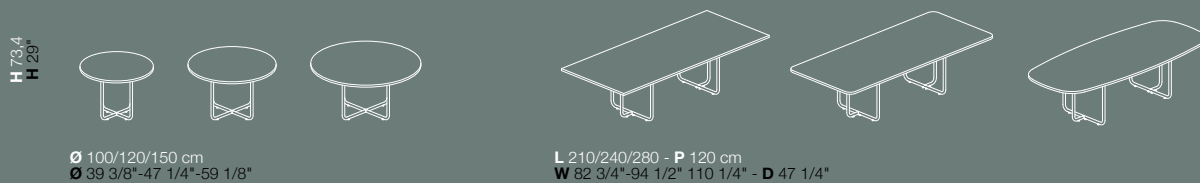

# Finiture | Finishes | Finitions | Acabados

## MEL

### Melaminico

Melamine | Mèlaminé | Melamina

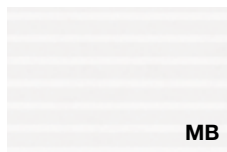

**Bianco rigato**  
Rippled effect white  
Blanc avec rayures en sérigraphie  
Blanco rayado

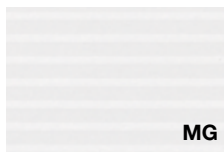

**Grigio rigato**  
Rippled effect grey  
Gris avec rayures en sérigraphie  
Gris rayado



**Nichel**  
Nickel  
Nickel  
Niquel

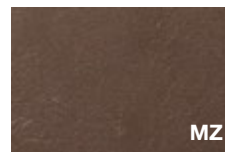

**Cacao**  
Cocoa  
Cacao  
Cacao

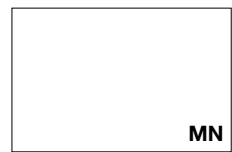

**Bianco**  
White  
Blanc  
Blanco

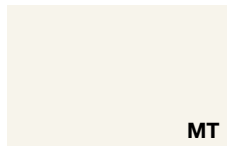

**Talco**  
Talco  
Talco  
Talco



**Ocra**  
Ochre  
Ocre  
Ocre



**Terracotta**  
Terracotta  
Terre cuite  
Terracota



**Safari**  
Safari  
Safari  
Safari



**Noisette**  
Noisette  
Noisette  
Noisette



**Verde**  
Green  
Vert  
Verde



**Nero**  
Black  
Noir  
Negro



**Blu notte**  
Night blue  
Bleu nuit  
Azul noche

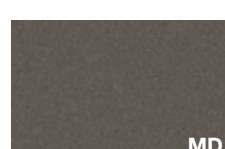

**Ardesia**  
Ardesia  
Ardesia  
Pizarra



**Rovere chiaro**  
Light oak  
Chêne clair  
Roble claro



**Rovere americano**  
American oak  
Chêne américain  
Roble americano

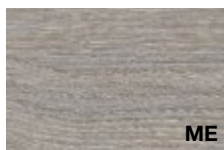

**Rovere grigio**  
Grey oak  
Chêne gris  
Roble gris



**Rovere moro**  
Dark oak  
Chêne foncé  
Roble oscuro



**Noce Canaletto**  
Canaletto Walnut  
Noyer Canaletto  
Nogal Canaletto

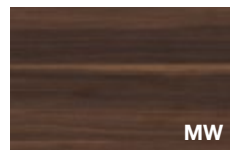

**Noce scuro**  
Dark walnut  
Noyer foncé  
Nogal oscuro

## **FNX**

### **Fenix**

Fenix | Fenix | Fenix

TOP



**Bianco**  
White  
Blanc  
Blanco



**Beige Arizona**  
Arizona beige  
Beige Arizona  
Beige Arizona



**Blu Fes**  
Fes blue  
Bleu Fes  
Azul Fes



**Grigio Bromo**  
Bromo grey  
Gris Bromo  
Gris Bromo



**Verde Comodoro**  
Comodoro green  
Vert Comodoro  
Verde Comodoro



**Nero**  
Black  
Noir  
Negro



**Rosso Jaipur**  
Jaipur red  
Rouge Jaipur  
Rojo Jaipur

## **FLT**

### **Feltro**

Felt | Rassentie | Fieltro

TND



**Sabbia**  
Cream  
Sable  
Arena

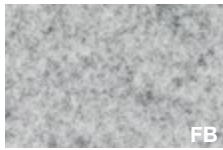

**Grigio chiaro**  
Light grey  
Gris clair  
Gris claro

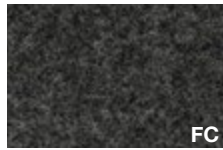

**Grigio scuro**  
Dark grey  
Gris foncé  
Gris oscuro



**Blu melange**  
Melange blue  
Bleu mélangé  
Azul melange



**Verde scuro**  
Dark green  
Vert foncé  
Verde oscuro



**Marrone**  
Brown  
Marron  
Marrón



**Rosso bordeaux**  
Burgundy red  
Rouge bordeaux  
Rojo burdeos

**PET**

**Techpanel**

Techpanel | Techpanel | Paño



**Dark grey**  
Dark grey  
Gris foncé  
Gris oscuro

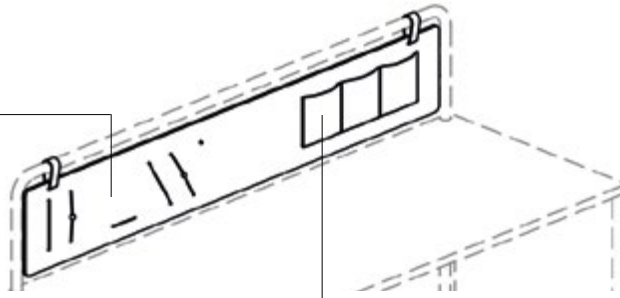

**FLT**

**Feltro**

Felt | Rassentie | Fieltro



**Sabbia**  
Cream  
Sable  
Arena

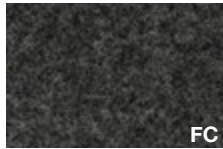

**Grigio scuro**  
Dark grey  
Gris foncé  
Gris oscuro



**TES**

**Tessuto**

Fabric | Tissu | Tejido



**Beige**  
Beige  
Beige  
Beige



**Grigio chiaro**  
Light grey  
Gris clair  
Gris claro



**Ardesia**  
Ardesia  
Ardesia  
Pizarra



**Blu avio**  
Avio blue  
Bleu avio  
Azul avio



**Acquamarina**  
Aquamarine  
Alugue-marine  
Aguamarina

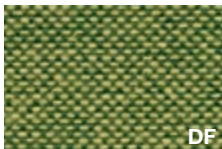

**Verde primavera**  
Spring green  
Vert printemps  
Verde primavera

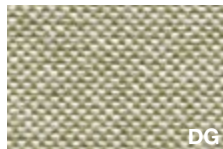

**Salvia**  
Sage  
Sauge  
Salvia



**Arancio**  
Orange  
Orange  
Naranja



**Corallo**  
Coral  
Corail  
Coral

## EPX

### Epossidico

Epoxy | Époxy | Epoxi

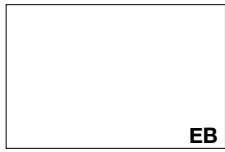

EB

#### Bianco

White  
Blanc  
Blanco



ET

#### Talco

Talco  
Talco  
Talco



EG

#### Grigio

Grey  
Gris  
Gris



YD

#### Beige Arizona

Arizona beige  
Beige Arizona  
Beige Arizona



EO

#### Noisette

Noisette  
Noisette  
Noisette



EK

#### Safari

Safari  
Safari  
Safari

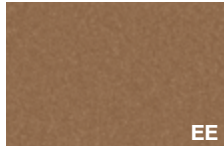

EE

#### Rame

Copper  
Cuivre  
Cobre



EH

#### Terracotta

Terracotta  
Terre cuite  
Terracota



YB

#### Rosso Jaipur

Jaipur red  
Rouge Jaipur  
Rojo Jaipur



EZ

#### Bronzo

Bronze  
Bronze  
Bronze



YQ

#### Blu notte

Night blue  
Bleu nuit  
Azul noche



YC

#### Grigio Bromo

Bromo grey  
Gris Bromo  
Gris Bromo

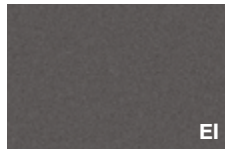

EI

#### Ardesia

Ardesia  
Ardesia  
Pizarra



YV

#### Verde Comodoro

Comodoro green  
Vert Comodoro  
Verde Comodoro



EN

#### Nero

Black  
Noir  
Negro

## Applicazioni finiture

Finish application | Application finitions | Aplicacion acabados



Top  
Piano  
Plateau  
Sobre



Screen  
Screen  
Écran  
Panel



Struttura  
Structure  
Structure  
Structura



Tenda  
Curtain  
Rideau  
Cortina



Tasche  
Pocket  
Poches  
Bolsillos

**Le finiture contenute nella stampa sono puramente indicative e non sono di riferimento per le forniture del prodotto**

Due to the printing process, finishes shown in this document are for illustration only. The finish on the final item may differ slightly from the printed illustration

Les finitions contenues dans l'impression sont purement indicatives et ne sont pas pertinentes pour les fournitures du produit

Los acabados contenidos en la impresión son puramente indicativos y no son de referencia para los suministros del producto

# Ambiente e sicurezza | Environment and safety | Environnement et sécurité | Medio ambiente y seguridad

**Ecologia:** Alea utilizza per i suoi prodotti e i suoi imballi materiali facilmente separabili e riciclabili. (Immagine 1)

**Catena Di Custodia COC:** Alea si impegna ad utilizzare materiali legnosi certificati FSC® e pannelli a base di legno con certificazione CARB2.

I pannelli CARB2 presentano un rilascio di formaldeide inferiore rispetto al pannello E1 comunemente utilizzato (classe E1 secondo il DM 10/10/2008).

I prodotti certificati FSC ® (License Code FSC-C118323) sono disponibili su richiesta: contattate i nostri uffici per maggiori informazioni. (Immagine 2)

**LEED:** Gli arredi di Alea possono contribuire al conseguimento del punteggio di certificazione LEED per i crediti indicati nei product badge. (Immagine 3)

**Sistemi di Gestione certificati ISO 9001, ISO 14001, ISO 45001:** Alea è attivamente impegnata nel raggiungere standard elevati di qualità e responsabilità attraverso l'adozione di sistemi di gestione certificati ISO per garantire prodotti e servizi di elevata qualità, in grado di soddisfare le aspettative dei clienti, di assicurare un ambiente di lavoro sicuro e di monitorare regolarmente l'impatto ambientale delle nostre attività. (Immagine 4)

**Attestazione di prodotto:** I prodotti Alea sono stati sottoposti a prove prestazionali presso laboratori di prova accreditati.

Copia dei rapporti di prova o delle attestazioni di conformità sono disponibili su richiesta. (Immagine 5)

**Eco-friendly:** Alea uses easily separable and recyclable materials for its products and packaging. (Image 1)

**Chain of Custody (COC):** Alea is committed to using FSC® certified wood materials and CARB2-certified wood-based panels. CARB2 panels have lower formaldehyde emissions compared to the commonly used E1 panels (class E1 according to the DM 10/10/2008). FSC® certified products (License Code FSC-C118323) are available upon request: please contact our offices for more information. (Image 2)

**LEED:** The A65 system can contribute to obtaining LEED certification points for the credits indicated in the product badges. (Image 3)

**ISO 9001, ISO 14001, ISO 45001 Certified Management Systems:** Alea is actively committed to achieving high standards of quality and responsibility through the adoption of ISO certified management systems to ensure high-quality products and services that meet customer expectations, provide a safe working environment, and regularly monitor the environmental impact of our activities. (Image 4)

**Product Certification:** Alea products have undergone performance tests by accredited testing laboratories. Copies of test reports or certificates of conformity are available upon request. (Image 5)



# Ambiente e sicurezza | Environment and safety | Environnement et sécurité | Medio ambiente y seguridad

**Écologie:** Alea utilise pour ses produits et ses emballages des matériaux facilement séparables et recyclables. (Image 1)

**Chaîne de contrôle COC:** Alea a à cœur d'utiliser des matériaux en bois certifiés FSC® et des panneaux à base de bois avec la certification CARB2.

Les panneaux CARB2 présentent une émission de formaldéhyde inférieure à celle des panneaux E1 couramment utilisés (classe E1 selon le DM 10/10/2008). Les produits certifiés FSC® (Code de licence FSC-C118323) sont disponibles sur demande : veuillez contacter nos bureaux pour plus d'informations. (Image 2)

**LEED:** Le système A65 peut contribuer à l'obtention des points de certification LEED pour les crédits indiqués dans les badges produits. (Image 3)

**Systèmes de gestion certifiés ISO 9001, ISO 14001, ISO 45001:** Alea s'engage activement à atteindre des normes élevées de qualité et de responsabilité à travers l'adoption de systèmes de gestion certifiés ISO pour garantir des produits et services de haute qualité, répondre aux attentes des clients, assurer un environnement de travail sûr et surveiller régulièrement l'impact environnemental de nos activités. (Image 4)

**Attestation de produit:** Les produits Alea ont été soumis à des tests de performance dans des laboratoires d'essais accrédités. Des copies des rapports de tests ou des certificats de conformité sont disponibles sur demande. (Image 5)

**Ecología:** Alea utiliza para sus productos y embalajes materiales fácilmente separables y reciclables. (Imagen 1)

**Cadena de Custodia COC:** Alea se compromete a utilizar materiales de madera certificados por FSC® y paneles a base de madera con certificación CARB2.

Los paneles CARB2 presentan una emisión de formaldehído inferior en comparación con los paneles E1 comúnmente utilizados (clase E1 según el DM 10/10/2008). Los productos certificados por FSC® (Código de Licencia FSC-C118323) están disponibles bajo solicitud: por favor contacte a nuestras oficinas para más información. (Imagen 2)

**LEED:** El sistema A65 puede contribuir a la consecución de la puntuación de certificación LEED para los créditos indicados en los product badges. (Imagen 3)

**Sistemas de Gestión Certificados ISO 9001, ISO 14001, ISO 45001:** Alea está comprometida activamente en alcanzar altos estándares de calidad y responsabilidad mediante la adopción de sistemas de gestión certificados por ISO para garantizar productos y servicios de alta calidad, que cumplen con las expectativas de los clientes, aseguran un entorno de trabajo seguro y monitorean regularmente el impacto ambiental de nuestras actividades. (Imagen 4)

**Certificación de Producto:** Los productos Alea han sido sometidos a pruebas de rendimiento en laboratorios acreditados. Las copias de los informes de prueba o los certificados de conformidad están disponibles bajo solicitud. (Imagen 5)



1.



2.



3.



4.



5.

**Le immagini dei prodotti visibili all'interno di questo catalogo sono inserite a scopo puramente indicativo**  
The images of the products visible in this catalogue are included for information purposes only  
Les images des produits visibles dans ce catalogue sont incluses à titre informatif uniquement  
Las imágenes de los productos visibles en este catálogo se incluyen sólo con fines informativos



**Concept & design**

Alea marketing + communication

**Art director**

Mirto Antonel

**Product design**

Mirto Antonel

**Si ringrazia M.artedesign**

[martedesign.it](http://martedesign.it)

AE/CACE/AC

**alea**  
aleaoffice.com



**ALEA HQ AND SHOWROOM:** Via Col de Rust, 19 - 33070 Sarone di Caneva (PN), Italia - tel +39 0434 777333 [www.aleaoffice.com](http://www.aleaoffice.com)  
email [info@aleaoffice.com](mailto:info@aleaoffice.com) **MILAN SHOWROOM:** Via Cino del Duca, 2 - 20122 Milano, Italia - email [info@aleaoffice.com](mailto:info@aleaoffice.com)

**PARIS SHOWROOM:** 176 Avenue Charles de Gaulle - 92200 Neuilly-sur-Seine, France - email [france@aleaoffice.com](mailto:france@aleaoffice.com)

**LONDON SHOWROOM:** 50-54 Clerkenwell Road - London, EC1M 5PS - email [ukoffice@aleaoffice.com](mailto:ukoffice@aleaoffice.com)

**NEW YORK SHOWROOM:** 25W, 31st Street, #9 - New York, NY 10001, USA - tel +1 305 4701200 - email [info@alea-usa.com](mailto:info@alea-usa.com)

**MIAMI SHOWROOM:** Midtown 2, 3449 NE 1st Avenue L-32 - Miami, FL 33137, USA - tel +1 305 4701200 - email [info@alea-usa.com](mailto:info@alea-usa.com)