

alea

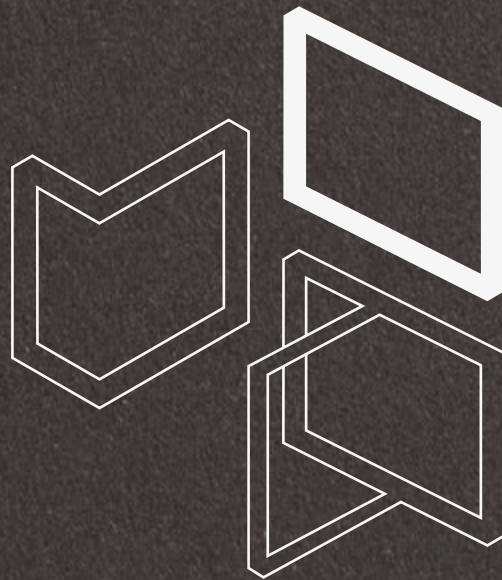

**Archimede**

---

executive

# Linearità

Archimede si distingue per il suo design lineare e leggero, adatto ad ambienti manageriali dal tocco moderno.

Archimede stands out for its linear and light design, suitable for managerial environments with a modern touch.

Archimede se distingue par son design linéaire et léger, adapté aux environnements managériaux avec une touche linéaire.

Archimede destaca por su diseño lineal y ligero, adecuado para entornos directivos con un toque moderno.

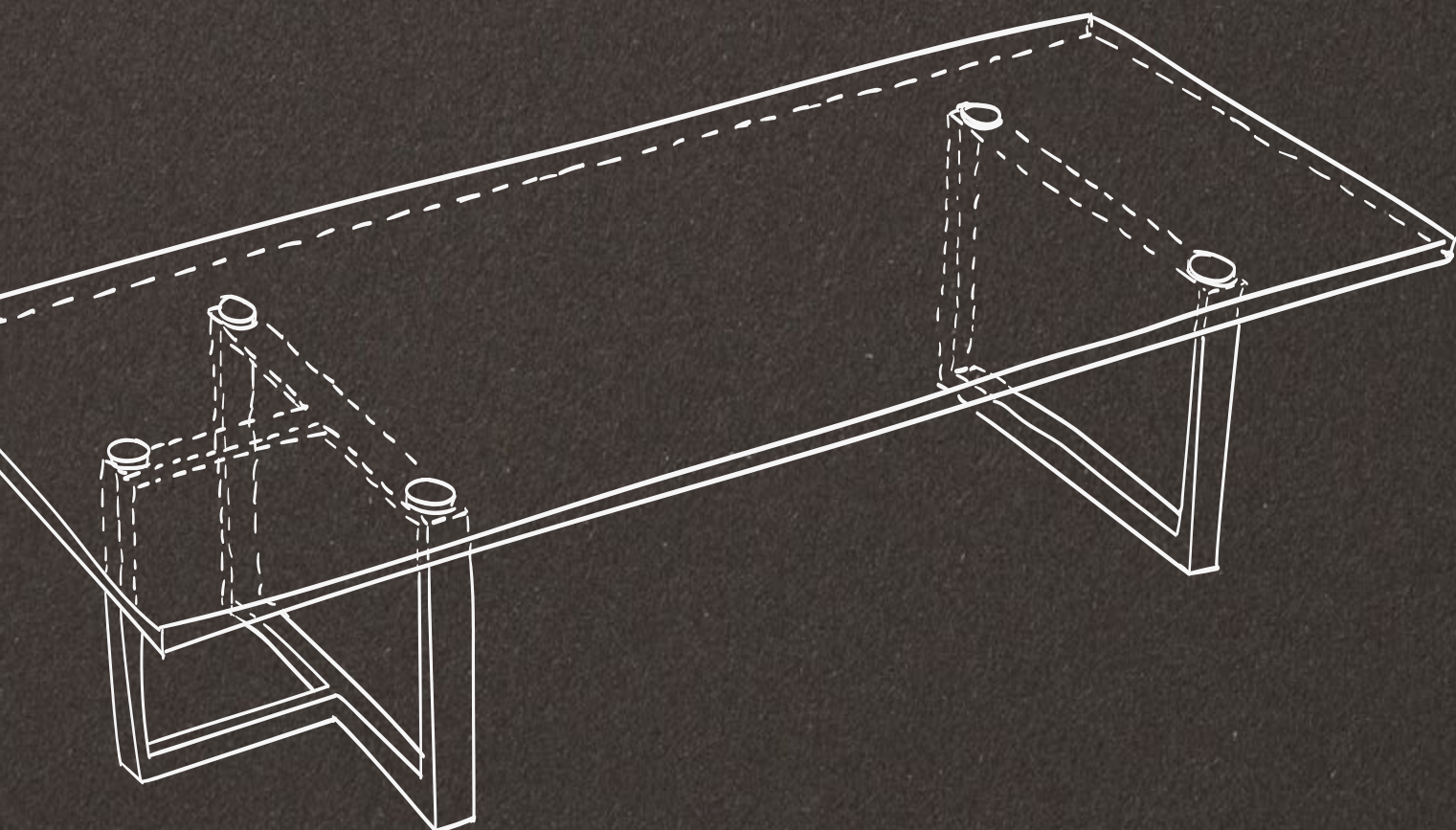







## Geometria

La struttura di Archimede è caratterizzata da gambe in metallo verniciato o in acciaio inox, che presentano tre opzioni di design (ad anello, a T e ad L) che si possono mescolare tra loro.

**Geometry** Archimede's structure is characterised by painted metal or stainless steel legs with three design options (ring, T-shaped and L-shaped) that can be mixed and matched.

**Géométrie** La structure d'Archimede est caractérisée par des pieds en métal peint ou en acier inoxydable, avec trois options de design (en anneau, en T et en L) qui peuvent être mélangées et assorties.

**Geometría** La estructura de Archimede se caracteriza por patas de metal pintado o acero inoxidable con tres opciones de diseño (en forma de anillo, en forma de T y en forma de L) que pueden mezclarse y combinarse.





**Scrivania** | Desk | Bureau | Mesa **Fin.** JN, EN  
**L** 280 **P** 120 cm | **W** 110 1/4" **D** 47 1/4"



**Scrivania** | Desk | Bureau | Mesa **Fin.** NO, EE  
L 240 P 120 cm | W 94 1/2" D 47 1/4"





**Scrivania** | Desk | Bureau | Mesa **Fin.** GY NFG, EN  
**L** 150 **P** 150 cm | **W** 59" **D** 59"  
**Moble di servizio** | Service unit | Meuble retour | Mueble de servicio **Fin.** AK, EN  
**L** 200 **P** 60 cm | **W** 78 3/4" **D** 23 5/8"





## **Look**

Archimede diventa elemento architettonico. I volumi e le forme si integrano perfettamente nello spazio circostante, creando un look elegante e contemporaneo.

**Look** Archimede becomes an architectural element. Volumes and shapes blend perfectly into the surrounding space, creating an elegant and contemporary look.

**Look** Archimede devient un élément architectural. Les volumes et les formes s'intègrent parfaitement à l'espace environnant, créant un look élégant et contemporain.

**Look** Archimede se convierte en un elemento arquitectónico. Los volúmenes y las formas se integran perfectamente en el espacio circundante, creando un aspecto elegante y contemporáneo.





**Scrivania** | Desk | Bureau | Mesa **Fin.** MT, ET  
L 240 P 90 cm | W 94 1/2" D 35 3/8"  
**Mobile di servizio** | Service unit | Meuble de service **Fin.** MT, ET  
L 240 P 60 cm | W 94 1/2" D 23 5/8"



## Organizzazione

La scrivania si può appoggiare al contenitore laterale, dotato di cassetti e vani chiusi da ante scorrevoli. Questo elemento è perfetto per organizzare lo spazio di lavoro mantenendo il massimo ordine.

**Organising** The desk can be supported by the lateral storage unit, which is equipped with drawers and compartments closed by sliding doors. This element is perfect for organising the work space while maintaining maximum tidiness.

**Organisation** Le bureau peut être placé sur le meuble de rangement latéral, qui est équipé de tiroirs et de compartiments fermés par des portes coulissantes. Cet élément est parfait pour organiser l'espace de travail tout en maintenant un ordre maximal.

**Organización** El escritorio puede colocarse sobre el mueble de almacenamiento lateral, equipado con cajones y compartimentos cerrados por puertas correderas. Este elemento es perfecto para organizar el espacio de trabajo manteniendo el máximo orden.









**Scrivanía** | Desk | Bureau | Mesa **Fin.** MM, EI  
L 240 P 90 cm | W 94 1/2" D 35 3/8"

**Mobile di servizio** | Service unit | Meuble retour | Mueble de servicio **Fin.** MD, EI  
L 240 P 90 cm | W 94 1/2" D 35 3/8"

Il contenitore laterale è disponibile in due profondità, 60 o 90 cm. La seconda opzione include dei vani a giorno sul lato esterno.

The lateral storage unit is available in two depths, 60 or 90 cm (23 5/8" or 35 3/8"). The second option includes open compartments on the outer side.



L'armoire latérale est disponible en deux profondeurs, 60 ou 90 cm. La deuxième option comprend des compartiments ouverts sur le côté extérieur.

El armario lateral está disponible en dos profundidades, 60 ó 90 cm. La segunda opción incluye compartimentos abiertos en el lado exterior.



**Scrivanìa** | Desk | Bureau | Mesa **Fin.** AK, MI, EO  
L 200 P 90 cm | W 78 3/4" D 35 3/8"  
**Dattìo** | Return | Retour | Ala **Fin.** AK, EO  
L 120 P 60 cm | W 47 1/4" D 23 5/8"



I dattìo possono arrivare fino ad una dimensione di 120 cm di lunghezza per 60 cm di profondità.

Returns can be up to 120 cm (47 1/4") wide by 60 cm (23 5/8") deep.

Les retours peuvent avoir une dimension maxi de 120 cm en longueur et 60 cm en profondeur.

Los dactìlos pueden medir hasta 120 cm de largo por 60 cm de profundidad.

**Tavolo** | Table | Mesa **Fin.** GN, CR  
**L** 280 **P** 120 cm | **W** 110 **1/4"** **D** 47 **1/4"**





## Dettagli

Il profilo in alluminio è disponibile in finitura brill oppure verniciato a polveri epossidiche ed accompagna sempre i piani in vetro, gres e cuoio, mentre è opzionale nella variante melaminico e legno impiallacciato.

**Details** The aluminium profile is available in brill or epoxy powder-coated finish. This element always comes with glass, porcelain tile and leather tops, while it is optional in the melamine and wood veneer variants.

**Détails** Le profilé en aluminium est disponible en finition brillante ou avec un revêtement en poudre époxy. Cet élément accompagne toujours les plateaux en verre, en grès et en cuir, tandis qu'il est en option dans les variantes en mélamine et en bois.

**Detalles** El perfil de aluminio está disponible en acabado brillante o con recubrimiento de polvo epoxi. Este elemento acompaña siempre a las encimeras de cristal, gres y cuero, mientras que es opcional en las variantes de melamina y madera.







**Tavolo** | Table | Table | Mesa **Fin.** NO, EE  
**L** 280 **P** 120 cm | **W** 110 1/4" **D** 47 1/4"





**Tavolo** | Table | Mesa | **Fin.** NT, EZ  
L 280 P 120 cm | **W** 110 1/4" | **D** 47 1/4"



## Nuove forme

Per i tavoli è stata introdotta una nuova forma del piano, organica ed armoniosa. Il taglio curvo e l'utilizzo dell'essenza legno rendono la composizione particolarmente raffinata.

**New shapes** A new, organic and harmonious top shape has been introduced for the tables. The curved cut and the use of wood veneer make it a particularly sophisticated composition.

**Nouvelles formes** Une nouvelle forme de plateau, organique et harmonieuse, a été introduite pour les tables. La forme incurvée et l'utilisation du bois en font une composition particulièrement raffinée.

**Nuevas formas** Se ha introducido una nueva forma de tablero, orgánica y armoniosa, para las mesas. El corte curvo y el uso de la madera hacen que la composición sea especialmente refinada.



## Riunioni

L'opzione legno è ora disponibile anche nelle dimensioni più grandi. I tavoli riunione in essenza raggiungono quindi i 120 cm di profondità ampliando il range di opzioni per le soluzioni meeting.

**Meet** The wood option is now available in larger dimensions. Veneer meeting tables reach a depth of 120 cm (47 1/4"), extending the range of options for boardroom solutions.

**Réunions** L'option bois est maintenant disponible dans de plus grandes dimensions. Les tables de réunion en bois ont donc une profondeur allant jusqu'à 120 cm, ce qui élargit l'éventail des options pour les solutions de réunion.

**Reuniones** La opción de madera ahora también está disponible tamaños más grandes. Las mesas de reuniones en madera tienen ahora hasta 120 cm de profundidad, lo que amplía la gama de opciones de soluciones para reuniones.



**Tavolo** | Table | Mesa **Fin.** NT, EI,  
L 440 P 120 cm | W 173 1/4" D 47 1/4"







**Tavolo** | Table | Mesa **Fin.** CN (leather custom), EN  
L 590 P 150 cm | W 232 1/4" D 59"



I tavoli si estendono fino a raggiungere i 590 cm di lunghezza. La composizione viene arricchita di due gambe ad anello centrali che aggiungono sostegno alla struttura.

The tables extend to a length of 590 cm (232 1/4"). The composition is enriched with two central ring legs that add support to the structure.

Les tables ont une longueur de 590 cm. La composition est enrichie de deux pieds anneaux centraux qui ajoutent du soutien à la structure.

Las mesas se extienden hasta una longitud de 590 cm. La composición se enriquece con dos patas anillo centrales que añaden soporte a la estructura.



## Collezione

Archimede comprende una selezione di complementi d'arredo che vanno a completare l'offerta. I tavolini da caffè ad esempio sono utili a definire aree più informali mantenendo i tratti distintivi della collezione.

**Collection** Archimede includes a selection of furnishing accessories to complete the offer. Coffee tables, for example, are useful for defining more informal areas while maintaining the distinctive features of the collection.

**Collection** Archimede propose une sélection d'accessoires d'ameublement pour compléter l'offre. Les tables basses, par exemple, sont utiles pour définir des zones plus informelles tout en conservant les caractéristiques distinctives de la collection.

**Colección** Archimede incluye una selección de accesorios de decoración para completar la oferta. Las mesas de centro, por ejemplo, resultan útiles para delimitar zonas más informales manteniendo los rasgos distintivos de la colección.





**Tavolino da caffè** | Coffee table | Table basse | Mesita **Fin. AK, EN**  
**L** 120 **P** 60 **H** 40 cm | **W** 47 1/4" **D** 23 5/8" **H** 15 3/4"



alea

alea

LIVES



**Libreria** | Bookcase | Bibliothèque | Libro **Fin.** MM, MJ, EI  
L 272 P 36 H 191 cm | W 107 1/8" D 14 1/8" H 75 1/4"

La libreria Archimede è definita da una struttura con disegno ad L, confermando la geometria distintiva della collezione. Viene proposta nella variante con 5 ripiani oppure ripiani e vano TV.

The Archimede bookcase is defined by an L-shaped structure, confirming the distinctive geometry of the collection. It is available in the variant with 5 shelves or shelves and TV compartment.

La bibliothèque Archimede est définie par une structure en forme de L, confirmant la géométrie distinctive de la collection. Elle est disponible dans la variante avec 5 étagères ou étagères et compartiment TV.

La librería Archimede se define por una estructura en forma de L, que confirma la geometría distintiva de la colección. Está disponible en la variante con 5 estantes o estantes y compartimento para TV.





**Piani** | Desk tops | Plateaux | Sobres

**Spessore 4 cm** | 4 cm (1 5/8") thick | 4 cm d'épaisseur | 4 cm de espesor



**Senza profilo - legno/melaminico**

Without profile - wood veneer/Italian melamine  
Sans profil - bois/mélangé  
Sin perfil - madera/melaminico

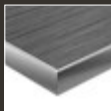

**Con profilo - legno/melaminico/cuoio/vetro/gres**

With profile - wood veneer/Italian melamine/leather/glass/porcelain tiles  
Avec profil - bois/mélangé/cuir/verre/grès cérame  
Con perfil - madera/melaminico/cuero/vidrio/gres porcelánico

**Gambe** | Legs | Pieds | Patas

**Sezione 8x2 cm** | Section 8x2 cm (3 1/8"x3/4") thick | Section 8x2 cm | Sección 8x2 cm

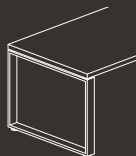

**Gamba ad anello**

Ring leg  
Pied en anneau  
Pata en anillo

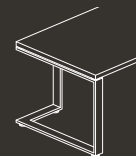

**gamba a L**

L leg  
pied en L  
pata en L



**Gamba a T**

T leg  
Pied en T  
Pata en T

**Scrivanie** | Desks | Bureaux | Mesas

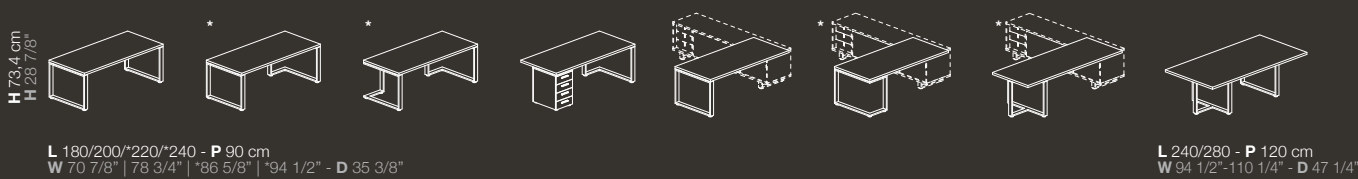

**Dattilo** | Returns | Retours | Alas

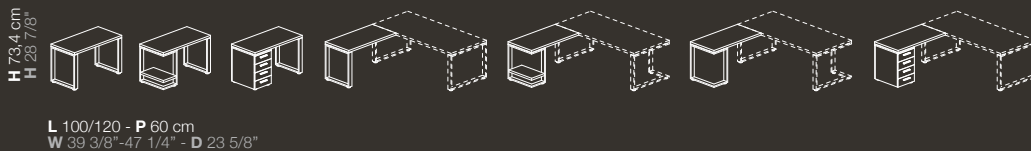

**Tavoli riunione** | Meeting tables | Tables de réunion | Mesas de juntas

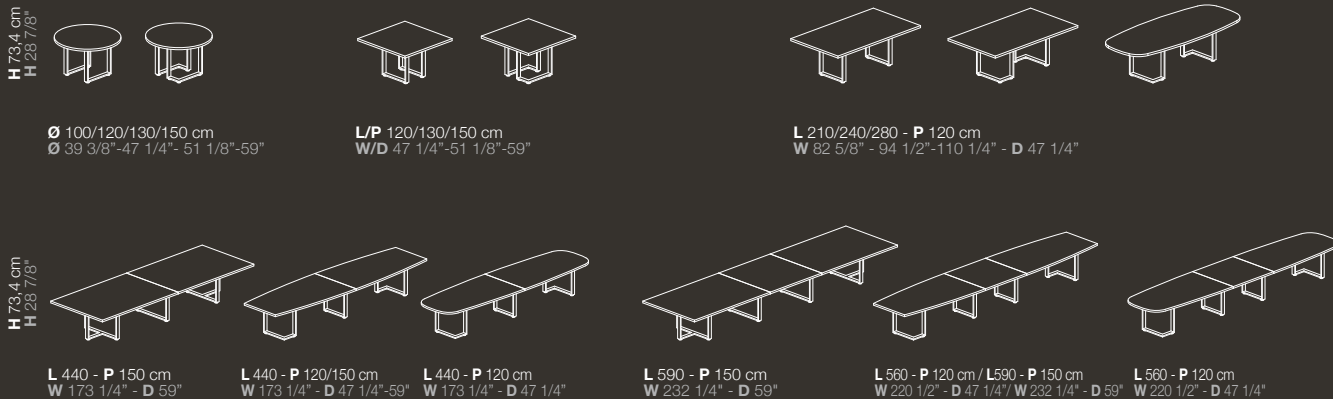

**Mobili di servizio** | Service units | Meuble retour | Muebles de servicio

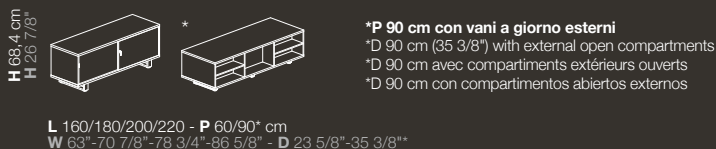

**Tavolini da caffè** | Coffee tables | Tables basses | Mesitas

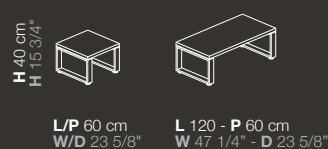

**Librerie** | Bookshelves | Bibliothèque | Libreros

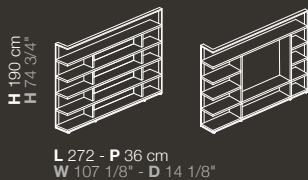





# Finiture | Finishes | Finitions | Acabados

## MEL

### Melaminico

Melamine | Mélaminé | Melaminico

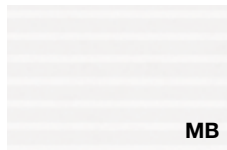

**Bianco rigato**  
Rippled effect white  
Blanc avec rayures en sérigraphie  
Blanco rayado

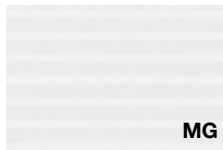

**Grigio rigato**  
Rippled effect grey  
Gris avec rayures en sérigraphie  
Gris rayado



**Nichel**  
Nickel  
Nickel  
Níquel



**Cacao**  
Cocoa  
Cacao  
Cacao



**Bianco**  
White  
Blanc  
Blanco

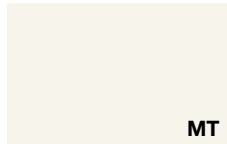

**Talco**  
Talco  
Talco  
Talco



**Odra**  
Ochre  
Ocre  
Ocre



**Terracotta**  
Terracotta  
Terre cuite  
Terracota



**Safari**  
Safari  
Safari  
Safari



**Noisette**  
Noisette  
Noisette  
Noisette



**Verde**  
Green  
Vert  
Verde



**Nero**  
Black  
Noir  
Negro



**Blu notte**  
Night blue  
Bleu nuit  
Azul noche

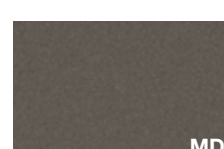

**Ardesia**  
Ardesia  
Ardesia  
Pizarra

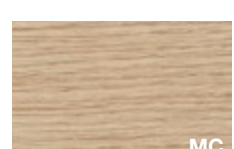

**Rovere chiaro**  
Light oak  
Chêne clair  
Roble claro

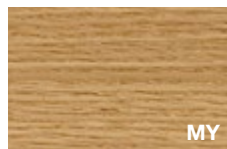

**Rovere americano**  
American oak  
Chêne américain  
Roble americano

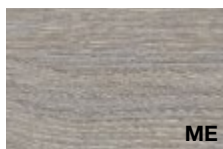

**Rovere grigio**  
Grey oak  
Chêne gris  
Roble gris

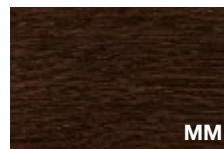

**Rovere moro**  
Dark oak  
Chêne foncé  
Roble oscuro

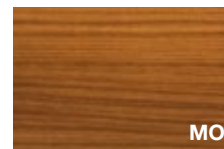

**Noce Canaletto**  
Canaletto Walnut  
Noyer Canaletto  
Nogal Canaletto

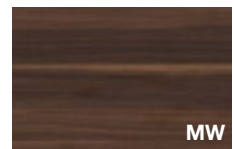

**Noce scuro**  
Dark walnut  
Noyer foncé  
Nogal oscuro

## LGN

### Legno

Wood | Bois | Madera



**Rovere chiaro**  
Light oak  
Chêne clair  
Roble claro



**Rovere grigio fumo**  
Smoke grey oak  
Chêne gris de fumée  
Roble gris humo

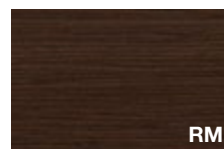

**Rovere moro**  
Dark oak  
Chêne foncé  
Roble oscuro

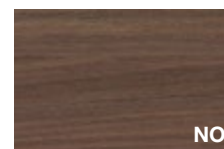

**Noce Canaletto**  
Canaletto walnut  
Noyer Canaletto  
Nogal Canaletto



**Ebano silver**  
Silver ebony  
Ebony silver  
Ebano plata



**Ebano Makassar**  
Makassar ebony  
Ebony Makassar  
Ebano Makassar



**Noce termocotto**  
Heat-treated walnut  
Noyer thermo traité  
Nogal termotratado

## VTR

### Vetro (anche antimpronta NFG)

Glass (also antifinger NFG) | Verre (également antitaches) | Vidrio (también anti-huella)

TOP



**Bianco**  
White  
Blanc  
Blanco



**Argento**  
Silver  
Argent  
Plata



**Grigio scuro**  
Dark grey  
Gris foncé  
Gris oscuro



**Noisette**  
Noisette  
Noisette  
Noisette



**Ardesia**  
Ardesia  
Ardesia  
Pizarra



**Moka**  
Mocha  
Moka  
Cafe



**Nero**  
Black  
Noir  
Negro



**Arancione**  
Orange  
Orange  
Naranja



**Rosso "F"**  
Red "F"  
Rouge "F"  
Rojo "F"



**Rubino**  
Ruby  
Rubis  
Rubi



**Indaco**  
Indigo  
Indigo  
Azul Indigo



**Azzurro**  
Blue  
Bleu  
Azul



**Verde**  
Green  
Vert  
Verde



**Cedro**  
Lime green  
Vert Cédrat  
Verde Cedro

## GRES

### Gres porcellanato

Porcelain tiles | Grès cérame | Gres porcelánico

TOP

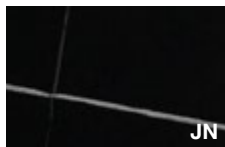

**Nero**  
Black  
Noir  
Negro



**Basalt**  
Basalt  
Basalt  
Basalt

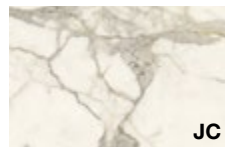

**Calacatta**  
Calacatta  
Calacatta  
Calacatta



**Pulpis**  
Pulpis  
Pulpis  
Pulpis

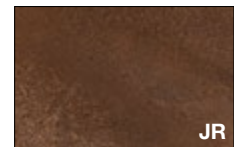

**Corten**  
Corten  
Corten  
Corten

## **CUO**

### **Cuoio**

Leather | Cuir | Cuero

TOP

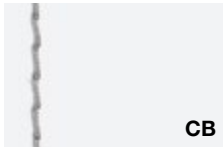

**Bianco**  
White  
Blanc  
Blanco



**Alluminio**  
Aluminium  
Aluminium  
Aluminio



**Nero**  
Black  
Noir  
Negro



**Testa di moro**  
Brown  
Tete de maure  
Marron oscuro



**Caramello**  
Caramel  
Caramel  
Caramelo



**Arancione**  
Orange  
Orange  
Naranja

## **MTC**

### **Metacrilato**

Acrylic | Méthacrylate | Metacrilato

MOB



**Bianco opalino**  
Opaline white  
Blanc opalin  
Blanco opaco

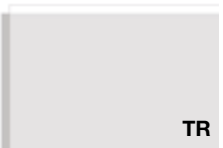

**Trasparente**  
Transparent  
Transparent  
Transparente



**Rosso trasparente**  
Red transparent  
Rouge transparent  
Rojo transparente



**Blu trasparente**  
Blue transparent  
Bleu transparent  
Azul transparente



**Bianco satinato**  
Satin-finish white  
Blanc satiné  
Blanco satinado



**Grigio fumè satinato**  
Satin-finish smoky grey  
Gris satiné  
Gris satinado



**Arancione satinato**  
Satin-finish orange  
Orange satiné  
Naranja satinado



**Blu satinato**  
Satin-finish blue  
Bleu satiné  
Azul satinado



**Verde satinato**  
Satin-finish green  
Vert satiné  
Verde satinado

## GOF

### Metacrilato retrolaccato

Backpainted acrylic | Méthacrylate rétro-laqué | Metacrilato retrolacado

MOB



GW

#### Bianco

White  
Blanc  
Blanco



GZ

#### Argento

Silver  
Argent  
Plata



GK

#### Grigio scuro

Dark grey  
Gris foncé  
Gris oscuro



GN

#### Noisette

Noisette  
Noisette  
Noisette



GA

#### Ardesia

Ardesia  
Ardesia  
Pizarra



GF

#### Moka

Mocha  
Moka  
Cafe



GY

#### Nero

Black  
Noir  
Negro



GX

#### Arancione

Orange  
Orange  
Naranja



GQ

#### Rosso "F"

Red "F"  
Rouge "F"  
Rojo "F"



GO

#### Rubino

Ruby  
Rubis  
Rubi



GD

#### Indaco

Indigo  
Indigo  
Azul Indigo



GT

#### Azzurro

Blue  
Bleu  
Azul



GU

#### Verde

Green  
Vert  
Verde



GR

#### Cedro

Lime green  
Vert Cédrat  
Verde Cedro

## CRM

### Acciaio inox

Stainless steel | Acier inoxydable | Acero inoxidable

STRU



CR

#### Lucido

Polished  
Poli  
Pulido

## BR

### Brill

Brill | Brill | Brill

PR



BR

#### Brill

Brill  
Brill  
Brill

## AL

### Alluminio

Aluminium | Aluminium | Aluminio

PR



AL

#### Alluminio

Aluminium  
Aluminium  
Aluminio

## EPX

### Epossidico

Epoxy | Époxy | Epoxi



EB

#### Bianco

White  
Blanc  
Blanco

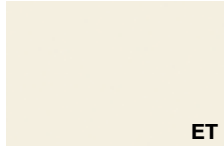

ET

#### Talco

Talco  
Talco  
Talco



EG

#### Grigio

Grey  
Gris  
Gris



YD

#### Beige Arizona

Arizona beige  
Beige Arizona  
Beige Arizona



EO

#### Noisette

Noisette  
Noisette  
Noisette



EK

#### Safari

Safari  
Safari  
Safari

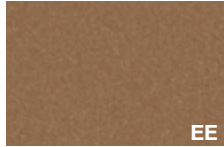

EE

#### Rame

Copper  
Cuivre  
Cobre



EH

#### Terracotta

Terracotta  
Terre cuite  
Terracota



YB

#### Rosso Jaipur

Jaipur red  
Rouge Jaipur  
Rojo Jaipur



EZ

#### Bronzo

Bronze  
Bronze  
Bronce



YQ

#### Blu notte

Night blue  
Bleu nuit  
Azul noche



YC

#### Grigio Bromo

Bromo grey  
Gris Bromo  
Gris Bromo

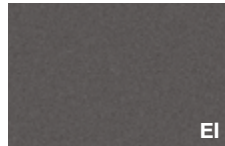

EI

#### Ardesia

Ardesia  
Ardesia  
Pizarra



YV

#### Verde Comodoro

Comodoro green  
Vert Comodoro  
Verde Comodoro



EN

#### Nero

Black  
Noir  
Negro

## Applicazioni finiture

Finish application | Application finitions | Aplicacion acabados



**Piano**  
Top  
Plateau  
Sobre



**Modesty panel**  
Modesty panel  
Voile de fond  
Faldón



**Mobile di servizio**  
Service unit  
Meuble de service  
Mueble de servicio



**Struttura**  
Structure  
Structure  
Structura



**Profilo scrivania**  
Top edge  
Chant plateau  
Perfil sobre de mesa



# Ambiente e sicurezza | Environment and safety | Environnement et sécurité | Medio ambiente y seguridad

**Ecologia:** Alea utilizza per i suoi prodotti e i suoi imballi materiali facilmente separabili e riciclabili. (Immagine 1)

**Catena Di Custodia COC:** Alea si impegna ad utilizzare materiali legnosi certificati FSC® e pannelli a base di legno con certificazione CARB2.

I pannelli CARB2 presentano un rilascio di formaldeide inferiore rispetto al pannello E1 comunemente utilizzato (classe E1 secondo il DM 10/10/2008).

I prodotti certificati FSC ® (License Code FSC-C118323) sono disponibili su richiesta: contattate i nostri uffici per maggiori informazioni. (Immagine 2)

**LEED:** Gli arredi di Alea possono contribuire al conseguimento del punteggio di certificazione LEED per i crediti indicati nei product badge. (Immagine 3)

**Sistemi di Gestione certificati ISO 9001, ISO 14001, ISO 45001:** Alea è attivamente impegnata nel raggiungere standard elevati di qualità e responsabilità attraverso l'adozione di sistemi di gestione certificati ISO per garantire prodotti e servizi di elevata qualità, in grado di soddisfare le aspettative dei clienti, di assicurare un ambiente di lavoro sicuro e di monitorare regolarmente l'impatto ambientale delle nostre attività. (Immagine 4)

**Attestazione di prodotto:** I prodotti Alea sono stati sottoposti a prove prestazionali presso laboratori di prova accreditati.

Copia dei rapporti di prova o delle attestazioni di conformità sono disponibili su richiesta. (Immagine 5)

**Eco-friendly:** Alea uses easily separable and recyclable materials for its products and packaging. (Image 1)

**Chain of Custody (COC):** Alea is committed to using FSC® certified wood materials and CARB2-certified wood-based panels. CARB2 panels have lower formaldehyde emissions compared to the commonly used E1 panels (class E1 according to the DM 10/10/2008). FSC® certified products (License Code FSC-C118323) are available upon request: please contact our offices for more information. (Image 2)

**LEED:** The A65 system can contribute to obtaining LEED certification points for the credits indicated in the product badges. (Image 3)

**ISO 9001, ISO 14001, ISO 45001 Certified Management Systems:** Alea is actively committed to achieving high standards of quality and responsibility through the adoption of ISO certified management systems to ensure high-quality products and services that meet customer expectations, provide a safe working environment, and regularly monitor the environmental impact of our activities. (Image 4)

**Product Certification:** Alea products have undergone performance tests by accredited testing laboratories. Copies of test reports or certificates of conformity are available upon request. (Image 5)



# Ambiente e sicurezza | Environment and safety | Environnement et sécurité | Medio ambiente y seguridad

**Écologie:** Alea utilise pour ses produits et ses emballages des matériaux facilement séparables et recyclables. (Image 1)

**Chaîne de contrôle COC:** Alea a à cœur d'utiliser des matériaux en bois certifiés FSC® et des panneaux à base de bois avec la certification CARB2.

Les panneaux CARB2 présentent une émission de formaldéhyde inférieure à celle des panneaux E1 couramment utilisés (classe E1 selon le DM 10/10/2008). Les produits certifiés FSC® (Code de licence FSC-C118323) sont disponibles sur demande : veuillez contacter nos bureaux pour plus d'informations. (Image 2)

**LEED:** Le système A65 peut contribuer à l'obtention des points de certification LEED pour les crédits indiqués dans les badges produits. (Image 3)

**Systèmes de gestion certifiés ISO 9001, ISO 14001, ISO 45001:** Alea s'engage activement à atteindre des normes élevées de qualité et de responsabilité à travers l'adoption de systèmes de gestion certifiés ISO pour garantir des produits et services de haute qualité, répondre aux attentes des clients, assurer un environnement de travail sûr et surveiller régulièrement l'impact environnemental de nos activités. (Image 4)

**Attestation de produit:** Les produits Alea ont été soumis à des tests de performance dans des laboratoires d'essais accrédités. Des copies des rapports de tests ou des certificats de conformité sont disponibles sur demande. (Image 5)

**Ecología:** Alea utiliza para sus productos y embalajes materiales fácilmente separables y reciclables. (Imagen 1)

**Cadena de Custodia COC:** Alea se compromete a utilizar materiales de madera certificados por FSC® y paneles a base de madera con certificación CARB2.

Los paneles CARB2 presentan una emisión de formaldehído inferior en comparación con los paneles E1 comúnmente utilizados (clase E1 según el DM 10/10/2008). Los productos certificados por FSC® (Código de Licencia FSC-C118323) están disponibles bajo solicitud: por favor contacte a nuestras oficinas para más información. (Imagen 2)

**LEED:** El sistema A65 puede contribuir a la consecución de la puntuación de certificación LEED para los créditos indicados en los product badges. (Imagen 3)

**Sistemas de Gestión Certificados ISO 9001, ISO 14001, ISO 45001:** Alea está comprometida activamente en alcanzar altos estándares de calidad y responsabilidad mediante la adopción de sistemas de gestión certificados por ISO para garantizar productos y servicios de alta calidad, que cumplen con las expectativas de los clientes, aseguran un entorno de trabajo seguro y monitorean regularmente el impacto ambiental de nuestras actividades. (Imagen 4)

**Certificación de Producto:** Los productos Alea han sido sometidos a pruebas de rendimiento en laboratorios acreditados. Las copias de los informes de prueba o los certificados de conformidad están disponibles bajo solicitud. (Imagen 5)



1.



2.



3.



4.



5.

**Concept, visual & graphic design**

Alea marketing + communication

**Design**

Mirto Antonel

**Art direction**

Mirto Antonel

**Si ringrazia M.artedesign**

[martedesign.it](http://martedesign.it)

AD/CACD/AD

**Le immagini dei prodotti visibili all'interno di questo catalogo sono inserite a scopo puramente indicativo**  
The images of the products visible in this catalogue are included for information purposes only  
Les images des produits visibles dans ce catalogue sont incluses à titre informatif uniquement  
Las imágenes de los productos visibles en este catálogo se incluyen sólo con fines informativos

alea  
aleaoffice.com



**GLOBAL HEADQUARTERS AND SHOWROOM** : Via Col de Rust, 19 - 33070 Sarone (PN) - Italia : Tel ++39 0434 777 333  
email: info@aleaoffice.com **PARIS SHOWROOM** : 176 Avenue Charles de Gaulle 92200, Neuilly-sur-Seine - France **NORTH AMERICAN**  
**HEADQUARTERS** : Midtown 2, 3449 NE 1st Avenue L-32, Miami, FL 33137 - USA ; Tel ++1 305 470 1200 - email: info@alea-usa.com  
**ALEA UK OFFICE AND SHOWROOM** : 50-54 Clerkenwell Road, London EC1M 5PS - email: info@aleaoffice.com