

# alea

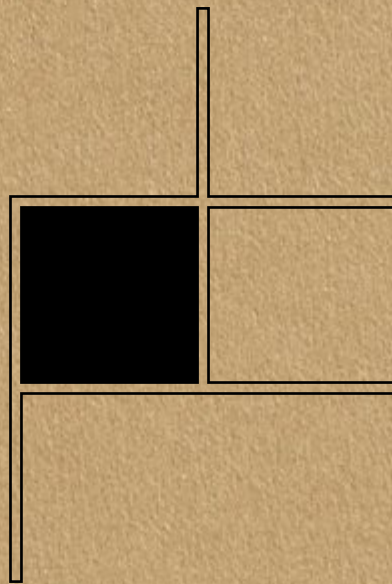

## Q18

---

modular bookshelves

# ABC di Q18

Sistema di fissaggio  
intelligente e ampia  
gamma di colori.

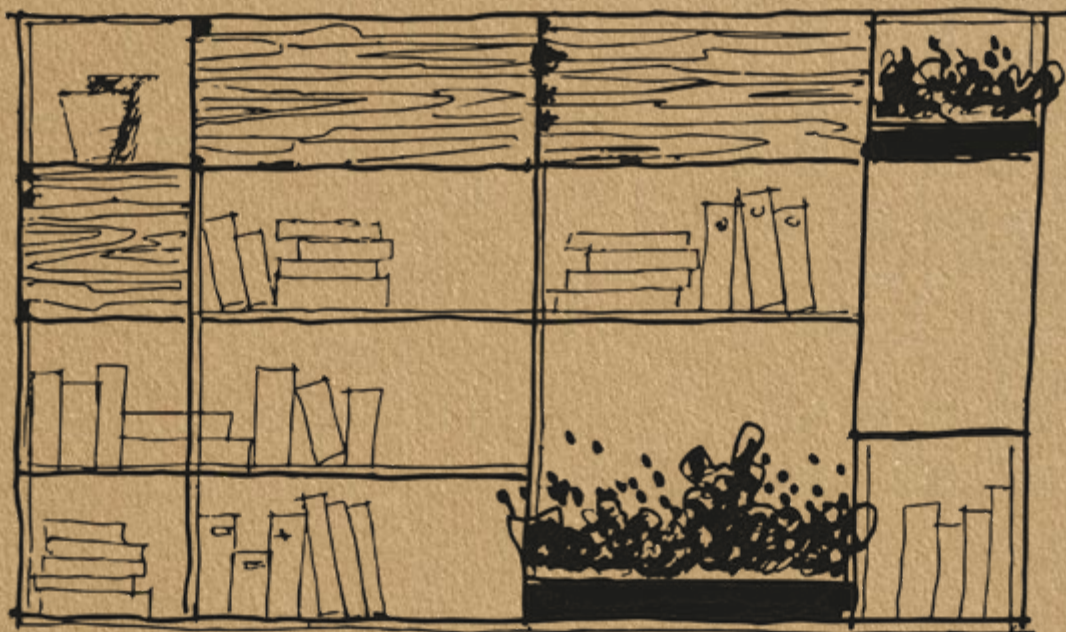

Smart fixing system  
and wide range of  
colours

Système de fixation  
intelligent et large  
gamme de couleurs

Sistema de fijación  
inteligente y amplia  
gama de colores

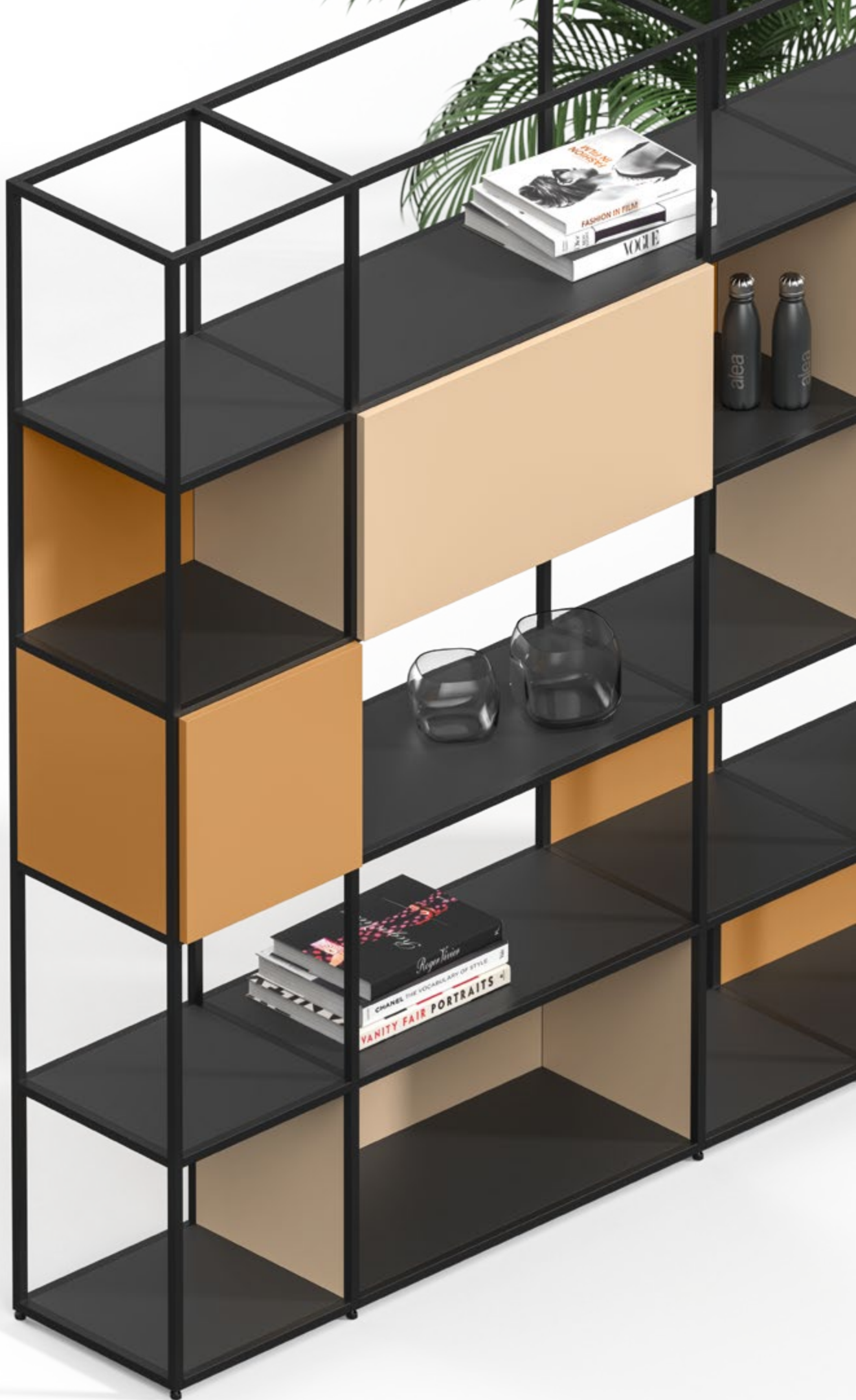

---

## Unicità

Il design unico del sistema di librerie Q18, è l'equilibrio perfetto tra complanarità dei componenti, libertà di layout e molteplici opzioni di colore. Sottile, elegante e personalizzabile, questo è Q18.

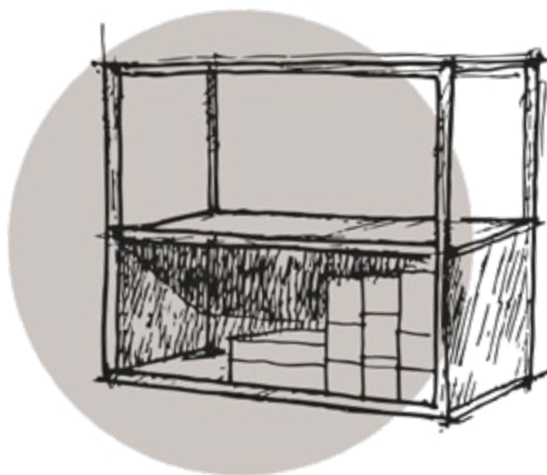

**Uniqueness** The unique design of the Q18 shelving system is the perfect balance between flushness of components, layout freedom and multiple colour options. Thin, elegant and customizable, this is Q18.





**Unicité** Le design unique du système d'étagères Q18 est l'équilibre parfait entre la fluidité des composants, la liberté d'agencement et les multiples options de couleurs. Mince, élégant et personnalisable, c'est le Q18.

**Único** El diseño único de la estantería Q18 es el equilibrio perfecto entre la coplanaridad de los componentes, la libertad de distribución y las múltiples opciones de color. Fino, elegante y personalizable, este es Q18.

## Minimalismo intelligente

Q18 è una soluzione modulare composta da una struttura in tubolare di alluminio con sezione 18x18 mm, alla quale vengono integrati pannelli e moduli contenitori. Il sistema di fissaggio intelligente che unisce le parti in alluminio rende questo prodotto elegante e pulito, senza viti a vista.



**Smart minimalism** Q18 is a modular solution consisting of a tubular aluminium structure with 18x18 mm section, to which panels and container modules are integrated. The intelligent fixing system that combines the aluminium parts makes this product elegant and clean, without visible screws.

**Minimalisme intelligent** Q18 est une solution modulaire constituée d'une structure tubulaire en aluminium de section 18x18 mm, à laquelle sont intégrés des panneaux et des modules de conteneurs. Le système de fixation intelligent qui combine les pièces en aluminium rend ce produit élégant et propre, sans vis apparentes.



**Minimalismo inteligente** Q18 es una solución modular que consiste en una estructura tubular de aluminio de sección 18x18 mm, a la que se integran paneles y módulos de contenedores. El sistema de fijación inteligente que combina las piezas de aluminio hace que este producto sea elegante y limpio, sin tornillos visibles.







---

## Modularità

Q18 è pensato per rispondere alle più svariate esigenze d'arredo. Per i moduli si può scegliere infatti tra 8 diverse larghezze, 3 profondità e 2 altezze. Schiene e fianchi possono essere sostituiti da tiranti in acciaio che sostengono la struttura conferendole anche un'alternativa estetica.





**Modularity** Q18 is designed to meet the most varied furnishing requirements. For the modules you can choose between 8 different widths, 3 depths and 2 heights. Back and sides can be replaced by steel tie rods that support the structure, giving it an aesthetic alternative.

**Modularité** Q18 est conçu pour répondre aux besoins d'ameublement les plus variés. Pour les modules, vous pouvez choisir entre 8 largeurs différentes, 3 profondeurs et 2 hauteurs. Le dos et les côtés peuvent être remplacés par des tirants en acier qui soutiennent la structure, ce qui lui donne une alternative esthétique.

**Modularidad** Q18 está diseñado para satisfacer las más variadas necesidades de mobiliario. Para los módulos se puede elegir entre 8 anchos diferentes, 3 profundidades y 2 alturas. La parte trasera y los laterales pueden ser sustituidos por tirantes de acero que soportan la estructura, dándole una alternativa estética.

LAY  
OUT

Endless  
layout  
possibilities:  
hints and  
notes

**Infinite  
possibilità  
di layout:  
spunti e  
appunti**

Infinitas  
posibilidades  
de diseño:  
consejos y  
notas

Infinies  
possibilités  
de layout:  
conseils et  
notes







---

## Elementi

Le composizioni Q18 si possono integrare con diverse tipologie di elementi. Ripiani, schiene, fianchi, cassettiere, moduli contenitori con ante battenti e a ribalta, vaschette porta piante possono essere aggiunti alla struttura per meglio adattarsi alle esigenze pratiche degli utilizzatori.



**Elements** Q18 compositions can be integrated with different types of elements. Shelves, backs, sides, drawer units, container modules with hinged and flap doors, planter boxes can be added to the structure to better adapt to the practical needs of users.

**Éléments** Les compositions du Q18 peuvent être intégrées avec différents types d'éléments. Des étagères, des dossiers, des côtés, des tiroirs, des modules de conteneurs avec des portes à charnières et à rabat, des plateaux à plantes peuvent être ajoutés à la structure pour mieux s'adapter aux besoins pratiques des utilisateurs.

**Elementos** Las composiciones Q18 pueden ser integradas con diferentes tipos de elementos. Estantes, respaldos, laterales, cajoneras, módulos contenedores con puertas batientes y abatibles, bandejas para plantas se pueden añadir a la estructura para adaptarse mejor a las necesidades prácticas de los usuarios.



---

## Opzioni

In base all'altezza e alla profondità scelta, Q18 si può utilizzare come sistema indipendente, piuttosto che fissato al muro oppure al soffitto. Anche l'appoggio a terra è disponibile in diverse opzioni: piedini bassi o rialzati oppure su ruote. Le ante dei contenitori sono progettate con sistema di apertura "push and pull" per marcare ulteriormente il design minimalista.



**Options** Depending on the height and depth chosen, Q18 can be used as a stand-alone system, rather than fixed to the wall or ceiling. The floor support is also available in different options: low or raised feet or on castors. Closed storage is fitted with push-pull closures so no handles are required maintaining a clean aesthetic.

**Options** Selon la hauteur et la profondeur choisies, Q18 peut être utilisé comme un système autonome, plutôt que d'être fixé au mur ou au plafond. Le support au sol est également disponible en différentes options: pieds bas ou surélevés ou sur roulettes. Les portes des conteneurs sont conçues avec un système d'ouverture par poussée et traction pour marquer davantage leur conception minimaliste.

**Opciones** Dependiendo de la altura y la profundidad elegidas, Q18 puede utilizarse como un sistema autónomo, en lugar de fijarse a la pared o al techo. El apoyo al suelo también está disponible en diferentes opciones: pies bajos o elevados o sobre ruedas. As puertas de los contenedores están diseñadas con un sistema de apertura de empujar y tirar para marcar aún más su diseño minimalista.







---

## Libertà di layout

Questa collezione ha la capacità di adattarsi a qualsiasi tipo di ambiente e soluzione d'arredo. Quasi nessun limite alla creatività, con soluzioni lineari o articolate che permettono di ottenere le più svariate geometrie.





**Layout freedom** This collection has the ability to adapt to any type of environment and furnishing solution. Almost no limits to creativity with linear runs or returns also incorporating worksurfaces at desk or standing height.

**Liberté de configuration** Cette collection a la capacité de s'adapter à tout type d'environnement et de solution d'ameublement. Presque aucune limite à la créativité, avec des solutions linéaires ou articulées qui permettent d'obtenir les géométries les plus variées.

**Libertad de configuración** Esta colección tiene la capacidad de adaptarse a cualquier tipo de entorno y solución de mobiliario. Casi sin límites a la creatividad, con soluciones lineales o articuladas que permiten obtener las más variadas geometrías.







La struttura di Q18 si adatta ad allestire gli interni spingendosi fino a diventare un vero e proprio elemento divisorio che può includere soluzioni a ponte.

The structure of Q18 can be adapted to fit out interiors and even become a real partition element that can include bridge solutions.

La structure de Q18 peut être adaptée aux intérieurs et peut même devenir un véritable cloison qui peut inclure des solutions de pont.

La estructura de Q18 puede adaptarse a los interiores e incluso convertirse en un verdadero elemento de separación que puede incluir soluciones de puente.





---

## Spazi ibridi

Q18 si adatta perfettamente alla creazione dei sempre più indispensabili spazi ibridi. In particolar modo i pannelli scrivibili svolgono non solo la funzione strutturale ma si possono utilizzare come lavagna per la condivisione delle idee.



Q18 is perfectly suited to the creation of increasingly indispensable hybrid spaces. In particular, the writable panels not only perform a structural function but can also be used as a whiteboard for sharing ideas.

Q18 est parfaitement adapté à la création d'espaces hybrides de plus en plus indispensables. En particulier, les panneaux inscriptibles n'ont pas seulement une fonction structurelle, mais ils peuvent également être utilisés comme tableau blanc pour partager des idées.

Q18 se adapta perfectamente a la creación de los cada vez más indispensables espacios híbridos. En concreto, los paneles escribibles no sólo cumplen una función estructural, sino que también pueden utilizarse como pizarra para compartir ideas.



## Palette di colori

l'ampia gamma di finiture e colori disponibili è il tocco finale. 18 diverse opzioni melaminiche per gli elementi pannellati, da abbinare alla struttura in metallo (in 16 diverse vernici epossidiche) per creare il miglior progetto personalizzato.



**Colour palette** The wide range of finishes and colours available is the finishing touch. 18 different melamine options for the panelled elements, to be combined with the metal structure (in 16 different epoxy paints) to create the best custom design.

**Palette de couleurs** La large gamme de finitions et de couleurs disponibles est la touche finale. 18 options différentes de mélamine pour les éléments lambrissés, à combiner avec la structure métallique (dans 16 peintures époxy différentes) pour créer le meilleur design personnalisé.



**Paleta de colores** La amplia gama de acabados y colores disponibles es el toque final. 18 opciones diferentes de melamina para los elementos panelados, que se pueden combinar con la estructura metálica (en 16 pinturas epoxídicas diferentes) para crear el mejor diseño personalizado.

## EPX pag.38

### Struttura in alluminio verniciato

Epoxy painted aluminium structure  
Structure en aluminium peinte  
Estructura de aluminio pintado

**Sezione quadrata 18x18 mm**  
Square section 18x18 mm (11/16")  
Section carrée 18x18 mm  
Sección cuadrada 18x18 mm



## MEL pag.37

**Pannelli**  
Panels  
Panneaux  
Paneles

### Schiene e fianchi

disponibili anche nella versione con tiranti in metallo  
Backs and sides also available in the version with metal tie rods

Dos et hanches également disponible dans la version avec tirants métalliques

Traseras y laterales: también disponibles en la versión con tirantes metálicos

**Supporto** 1. piedino esagonale (18 mm), 2. piedino esagonale rialzato (82 mm), 3. ruota (Ø 40 mm)  
Support: 1. hexagonal foot (18 mm - 11/16"), 2. raised hexagonal foot (82 mm - 3 1/4"), 3. castor (Ø 40 mm - 1 9/16")

Support: 1. pied hexagonal (18 mm), 2. pied hexagonal relevé (82 mm), 3. roulette (Ø 40 mm)

Soporte: 1. pie hexagonal (18 mm), 2. pie hexagonal elevado (82 mm), 3. rueda (Ø 40 mm)

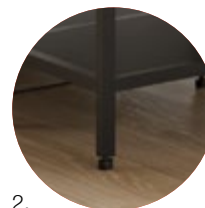

1.

2.

3.



## #01

### Schiene/fianchi anche scrivibili

Backs/sides also writable  
Fonds/cotés aussi à écrire  
Traseras/costados también para escribir

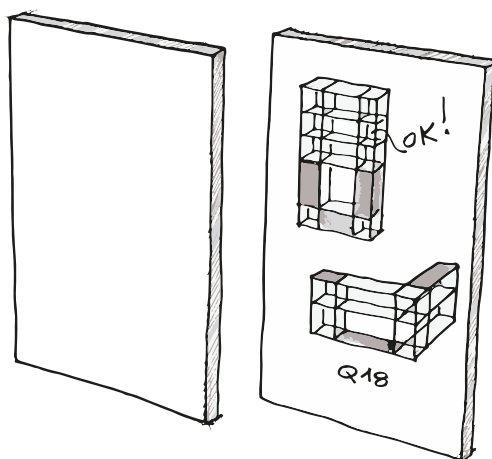

## #02

### Ripiani

Shelves  
Tablettes  
Estantes

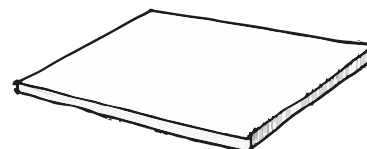

## #03

### Vani con anta battente o a ribalta anche scrivibili con sistema di apertura "push and pull"

Units with hinged or flap door also writable with "push and pull" opening system  
Rangements avec portes battantes ou abattantes pouvant servir d'écritoire avec système d'ouverture "push and pull"  
Módulos con puerta batiente o plegable también para escribir con sistema de apertura "push and pull"

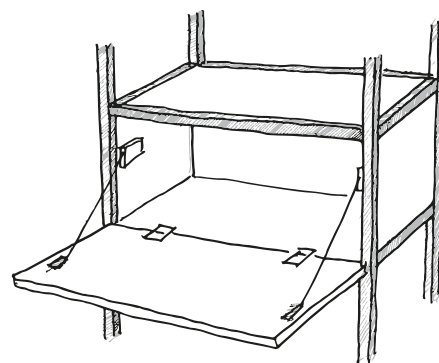
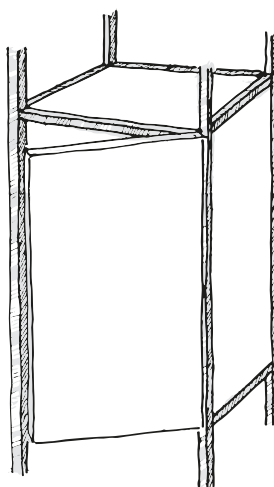
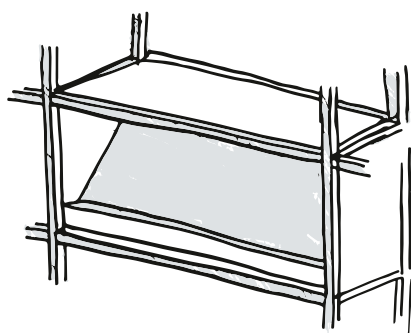

## #04

### Portariviste

Magazine holder  
Porte-revues  
Revistero

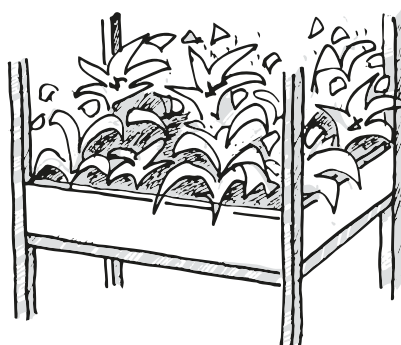

## #05

### Vaschette porta piante

Plant trays  
Vases à plantes  
Jardineras

## #06

### Cassetti/classificatori

Drawers/filing drawers  
Tiroirs/tiroirs pour DS  
Cajones/archivadores

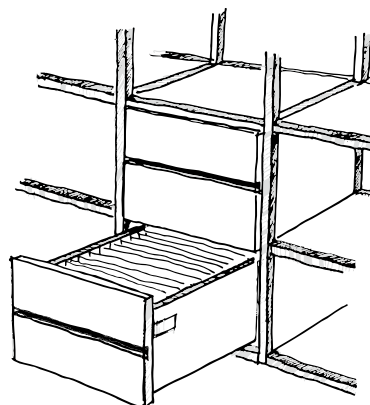
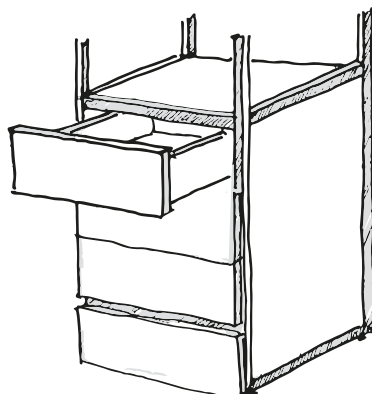

# Altezze | Heights | Hauteurs | Alturas



## MODULO 352 mm

13 7/8"

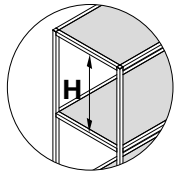

**H 334 mm**

13 1/8"

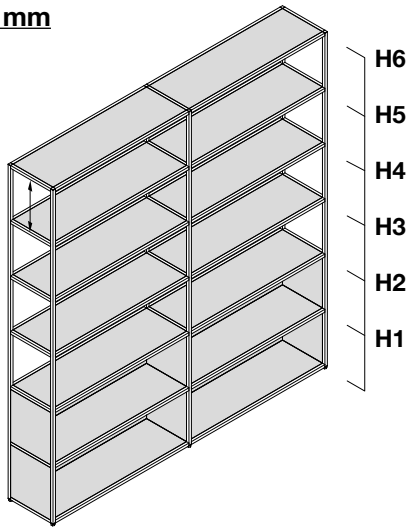

	18 mm 11/16"	82 mm 3 1/4"	44 mm 1 3/4"
<b>H1</b>	<b>388 mm</b> 15 1/4"	<b>452 mm</b> 17 13/16"	<b>414 mm</b> 16 5/16"
<b>H2</b>	<b>740 mm*</b> 29 1/8"	<b>804 mm</b> 31 5/8"	<b>766 mm</b> 30 3/16"
<b>H3</b>	<b>1092 mm</b> 43"	<b>1156 mm</b> 45 1/2"	<b>1118 mm</b> 44"
<b>H4</b>	<b>1444 mm</b> 56 7/8"	<b>1508 mm</b> 59 3/8"	
<b>H5</b>	<b>1796 mm</b> 70 11/16"	<b>1860 mm</b> 73 1/4"	
<b>H6</b>	<b>2148 mm</b> 84 9/16"	<b>2212 mm</b> 87 1/16"	

\* Altezze per scrivanie H 740 mm | Heights for desks H 740 mm (29 1/8") | Hauteurs pour bureaux H 740 mm | Alturas para escritorios H 740 mm

## MODULO 416 mm

16 3/8"

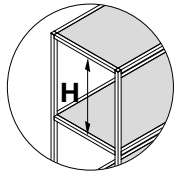

**H 398 mm**

15 11/16"

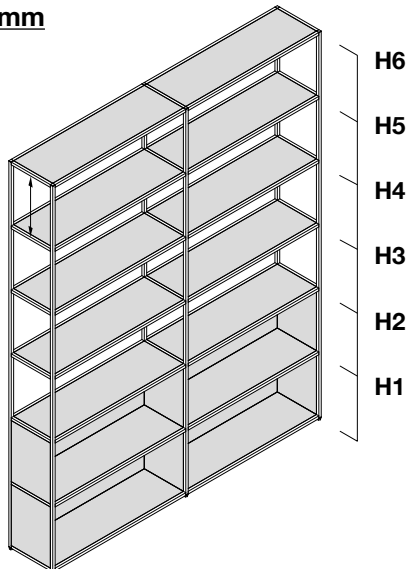

	18 mm 11/16"	82 mm 3 1/4"	44 mm 1 3/4"
<b>H1</b>	<b>452 mm</b> 17 13/16"	<b>516 mm</b> 20 5/16"	<b>478 mm</b> 18 13/16"
<b>H2</b>	<b>868 mm</b> 34 3/16"	<b>932 mm</b> 36 11/16"	<b>894 mm</b> 35 3/16"
<b>H3</b>	<b>1284 mm</b> 50 9/16"	<b>1348 mm</b> 53 1/16"	<b>1310 mm</b> 51 9/16"
<b>H4</b>	<b>1700 mm</b> 66 15/16"	<b>1764 mm</b> 59 3/8"	
<b>H5</b>	<b>2116 mm</b> 83 5/16"	<b>2180 mm</b> 85 13/16"	
<b>H6</b>	<b>2532 mm</b> 99 11/16"	<b>2596 mm</b> 102 3/16"	

# Larghezze | Widths | Largeurs | Anchuras

## MODULO 300 mm

11 13/16"

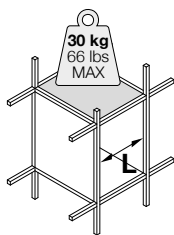

**L 282 mm**

11 1/8"

## MODULO 400 mm

15 3/4"

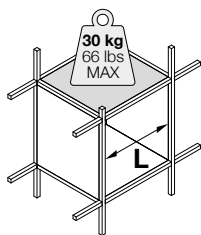

**L 382 mm**

15 1/16"

## MODULO 500 mm

19 11/16"

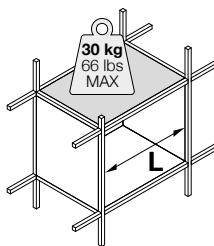

**L 482 mm**

19"

## MODULO 600 mm

23 5/8"

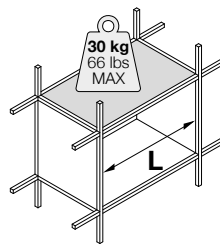

**L 582 mm**

22 15/16"

## MODULO 700 mm

27 9/16"

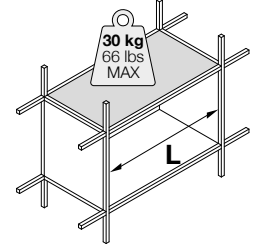

**L 682 mm**

26 7/8"

30 kg carico massimo per ciascuna mensola | 30 kg (66 lbs) maximum load for each shelf | 30 kg de charge maximale pour chaque étagère | 30 kg de carga máxima por cada estante

**MODULO 800 mm**  
31 1/2"

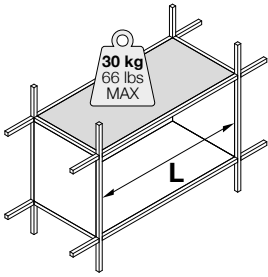

**L 782 mm**  
30 13/16"

**MODULO 900 mm**  
35 7/16"

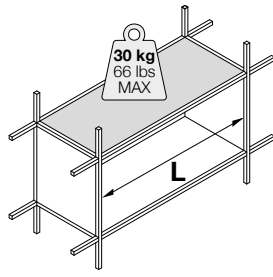

**L 882 mm**  
34 3/4"

**MODULO 1000 mm**  
39 3/8"

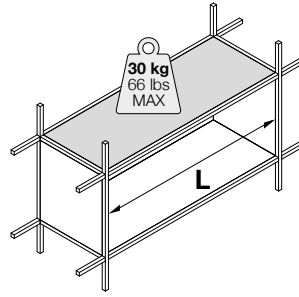

**L 982 mm**  
38 11/16"

**Profondità | Depths | Profondeurs | Profundidades**

**Su piedini** | on feet |  
sur pieds | con pies

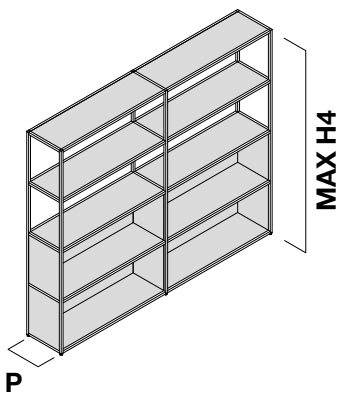

**P 330 mm**  
13"

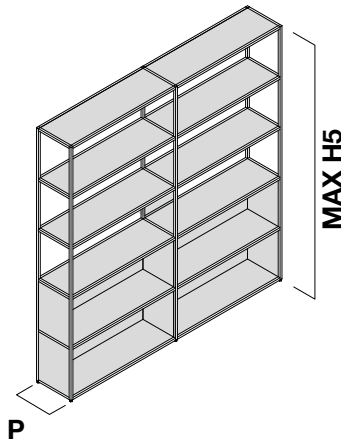

**P 394 | 458 mm**  
15 1/2" | 18"

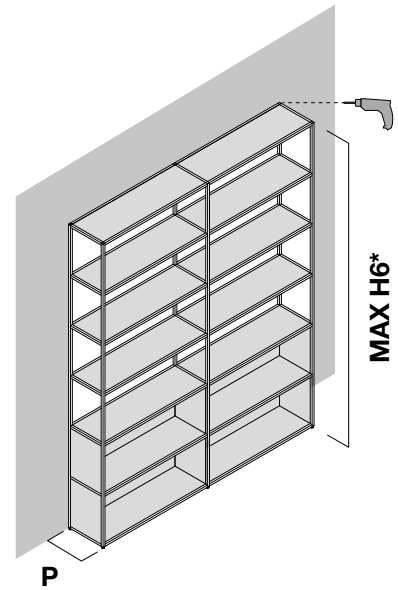

**P 330 | 394 | 458 mm**  
13" | 15 1/2" | 18"

\* Altezza massima se fissato al muro | Maximum height when fixed to the wall | Hauteur maximale en cas de fixation au mur | Altura máxima cuando se fija a la pared

**Su ruote** | on castors |  
sur roulettes | con ruedas

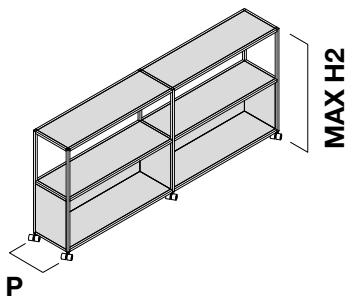

**P 330 mm**  
15 11/16"

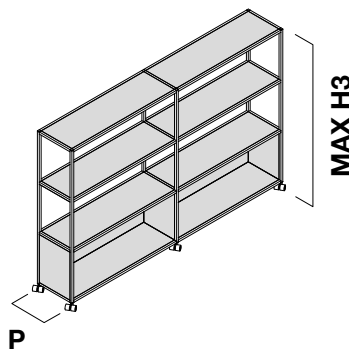

**P 394 | 458 mm**  
15 1/2" | 18"

**A soffitto** | ceiling-mounted |  
au plafond | en el techo

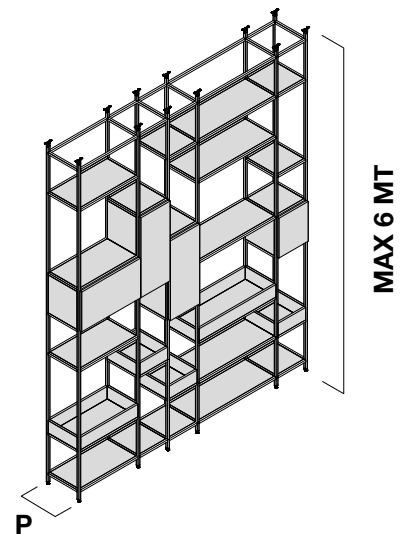

**P 330 | 394 | 458 mm**  
13" | 15 1/2" | 18"

**Configurazioni** | Layouts | Configurations | Configuraciones

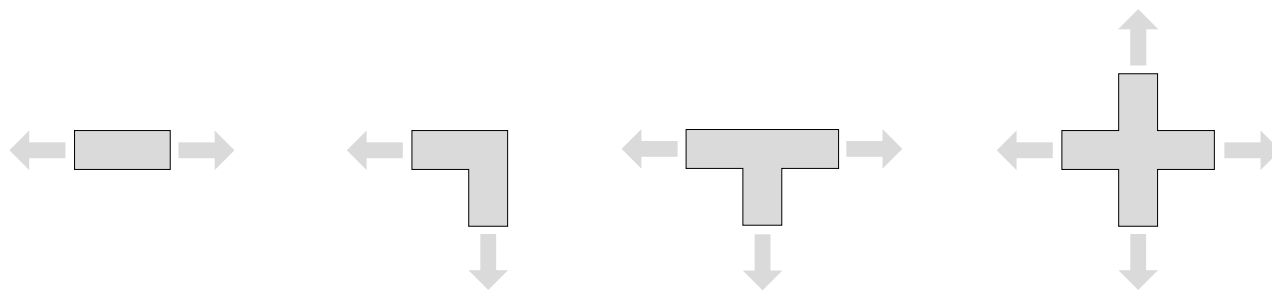

**Componenti** | Components | Composants | Componentes

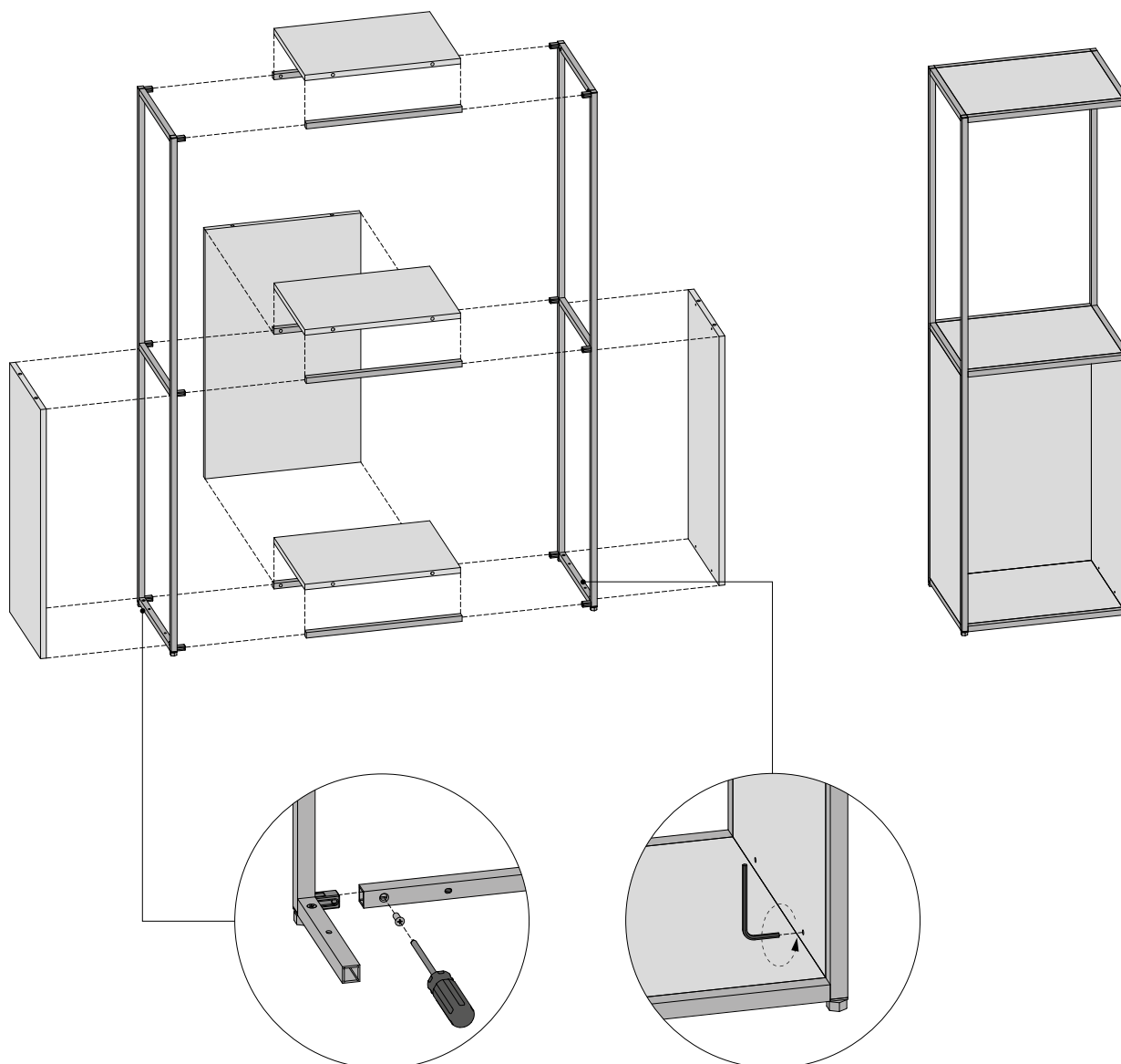











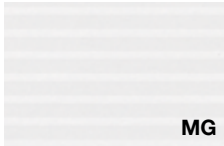



# Finiture | Finishes | Finitions | Acabados

## MEL

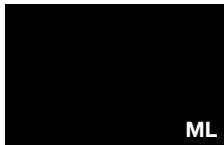
### Melaminico

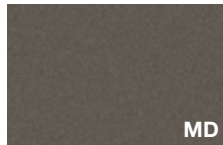
Melamine | Mélaminé | Melaminico

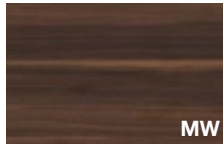

 <b>MB</b>	 <b>MG</b>	 <b>MF</b>	 <b>MZ</b>	 <b>MN</b>
<b>Bianco rigato</b> Rippled effect white Blanc avec rayures en sérigraphie Blanco rayado	<b>Grigio rigato</b> Rippled effect grey Gris avec rayures en sérigraphie Gris rayado	<b>Nichel</b> Nickel Nickel Níquel	<b>Cacao</b> Cocoa Cacao Cacao	<b>Bianco</b> White Blanc Blanco
 <b>MT</b>	 <b>MJ</b>	 <b>MH</b>	 <b>MK</b>	 <b>MI</b>
<b>Talco</b> Talco Talco Talco	<b>Ocre</b> Ochre Ocre Ocre	<b>Terracotta</b> Terracotta Terre cuite Terracota	<b>Safari</b> Safari Safari Safari	<b>Noisette</b> Noisette Noisette Noisette
 <b>MV</b>	 <b>ML</b>	 <b>MQ</b>	 <b>MD</b>	 <b>MC</b>
<b>Verde</b> Green Vert Verde	<b>Nero</b> Black Noir Negro	<b>Blu notte</b> Night blue Bleu nuit Azul noche	<b>Ardesia</b> Ardesia Ardesia Pizarra	<b>Rovere chiaro</b> Light oak Chêne clair Roble claro
 <b>MY</b>	 <b>ME</b>	 <b>MM</b>	 <b>MO</b>	 <b>MW</b>
<b>Rovere americano</b> American oak Chêne américain Roble americano	<b>Rovere grigio</b> Grey oak Chêne gris Roble gris	<b>Rovere moro</b> Dark oak Chêne foncé Roble oscuro	<b>Noce Canaletto</b> Canaletto Walnut Noyer Canaletto Nogal Canaletto	<b>Noce scuro</b> Dark walnut Noyer foncé Nogal oscuro

## MEL

### Melaminico scrivibile

Writable melamine | Mélamine à écrire | Melaminico para escribir

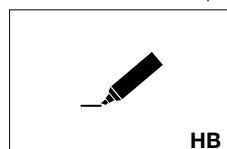

#### Bianco

White  
Blanc  
Blanco

**Le finiture contenute nella stampa sono puramente indicative e non sono di riferimento per le forniture del prodotto**  
Due to the printing process, finishes shown in this document are for illustration only. The finish on the final item may differ slightly from the printed illustration  
Les finitions contenues dans l'impression sont purement indicatives et ne sont pas pertinentes pour les fournitures du produit  
Los acabados contenidos en la impresión son puramente indicativos y no son de referencia para los suministros del producto



## EPX

### Epossidico

Epoxy | Époxy | Epoxi



**Bianco**  
White  
Blanc  
Blanco

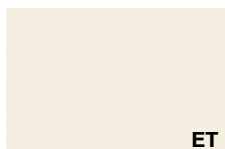

**Talco**  
Talco  
Talco  
Talco



**Grigio**  
Grey  
Gris  
Gris



**Beige Arizona**  
Arizona beige  
Beige Arizona  
Beige Arizona



**Noisette**  
Noisette  
Noisette  
Noisette



**Safari**  
Safari  
Safari  
Safari



**Rame**  
Copper  
Cuivre  
Cobre



**Terracotta**  
Terracotta  
Terre cuite  
Terracota



**Rosso Jaipur**  
Jaipur red  
Rouge Jaipur  
Rojo Jaipur



**Bronzo**  
Bronze  
Bronze  
Bronce



**Blu notte**  
Night blue  
Bleu nuit  
Azul noche



**Grigio Bromo**  
Bromo grey  
Gris Bromo  
Gris Bromo

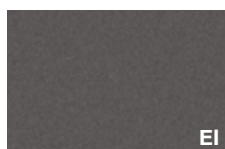

**Ardesia**  
Ardesia  
Ardesia  
Pizarra



**Verde Comodoro**  
Comodoro green  
Vert Comodoro  
Verde Comodoro



**Nero**  
Black  
Noir  
Negro

## Applicazioni finiture

Finish application | Application finitions | Aplicacion acabados

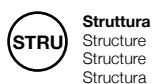

# Ambiente e sicurezza | Environment and safety | Environnement et sécurité | Medio ambiente y seguridad

**Ecologia:** Alea utilizza per i suoi prodotti e i suoi imballi materiali facilmente separabili e riciclabili. (Immagine 1)

**Catena Di Custodia COC:** Alea si impegna ad utilizzare materiali legnosi certificati FSC® e pannelli a base di legno con certificazione CARB2.

I pannelli CARB2 presentano un rilascio di formaldeide inferiore rispetto al pannello E1 comunemente utilizzato (classe E1 secondo il DM 10/10/2008).

I prodotti certificati FSC ® (License Code FSC-C118323) sono disponibili su richiesta: contattate i nostri uffici per maggiori informazioni. (Immagine 2)

**LEED:** Gli arredi di Alea possono contribuire al conseguimento del punteggio di certificazione LEED per i crediti indicati nei product badge. (Immagine 3)

**Sistemi di Gestione certificati ISO 9001, ISO 14001, ISO 45001:** Alea è attivamente impegnata nel raggiungere standard elevati di qualità e responsabilità attraverso l'adozione di sistemi di gestione certificati ISO per garantire prodotti e servizi di elevata qualità, in grado di soddisfare le aspettative dei clienti, di assicurare un ambiente di lavoro sicuro e di monitorare regolarmente l'impatto ambientale delle nostre attività. (Immagine 4)

**Attestazione di prodotto:** I prodotti Alea sono stati sottoposti a prove prestazionali presso laboratori di prova accreditati.

Copia dei rapporti di prova o delle attestazioni di conformità sono disponibili su richiesta. (Immagine 5)

**Eco-friendly:** Alea uses easily separable and recyclable materials for its products and packaging. (Image 1)

**Chain of Custody (COC):** Alea is committed to using FSC® certified wood materials and CARB2-certified wood-based panels. CARB2 panels have lower formaldehyde emissions compared to the commonly used E1 panels (class E1 according to the DM 10/10/2008). FSC® certified products (License Code FSC-C118323) are available upon request: please contact our offices for more information. (Image 2)

**LEED:** The A65 system can contribute to obtaining LEED certification points for the credits indicated in the product badges. (Image 3)

**ISO 9001, ISO 14001, ISO 45001 Certified Management Systems:** Alea is actively committed to achieving high standards of quality and responsibility through the adoption of ISO certified management systems to ensure high-quality products and services that meet customer expectations, provide a safe working environment, and regularly monitor the environmental impact of our activities. (Image 4)

**Product Certification:** Alea products have undergone performance tests by accredited testing laboratories. Copies of test reports or certificates of conformity are available upon request. (Image 5)



# Ambiente e sicurezza | Environment and safety | Environnement et sécurité | Medio ambiente y seguridad

**Écologie:** Alea utilise pour ses produits et ses emballages des matériaux facilement séparables et recyclables. (Image 1)

**Chaîne de contrôle COC:** Alea a à cœur d'utiliser des matériaux en bois certifiés FSC® et des panneaux à base de bois avec la certification CARB2.

Les panneaux CARB2 présentent une émission de formaldéhyde inférieure à celle des panneaux E1 couramment utilisés (classe E1 selon le DM 10/10/2008). Les produits certifiés FSC® (Code de licence FSC-C118323) sont disponibles sur demande : veuillez contacter nos bureaux pour plus d'informations. (Image 2)

**LEED:** Le système A65 peut contribuer à l'obtention des points de certification LEED pour les crédits indiqués dans les badges produits. (Image 3)

**Systèmes de gestion certifiés ISO 9001, ISO 14001, ISO 45001:** Alea s'engage activement à atteindre des normes élevées de qualité et de responsabilité à travers l'adoption de systèmes de gestion certifiés ISO pour garantir des produits et services de haute qualité, répondre aux attentes des clients, assurer un environnement de travail sûr et surveiller régulièrement l'impact environnemental de nos activités. (Image 4)

**Attestation de produit:** Les produits Alea ont été soumis à des tests de performance dans des laboratoires d'essais accrédités. Des copies des rapports de tests ou des certificats de conformité sont disponibles sur demande. (Image 5)

**Ecología:** Alea utiliza para sus productos y embalajes materiales fácilmente separables y reciclables. (Imagen 1)

**Cadena de Custodia COC:** Alea se compromete a utilizar materiales de madera certificados por FSC® y paneles a base de madera con certificación CARB2.

Los paneles CARB2 presentan una emisión de formaldehído inferior en comparación con los paneles E1 comúnmente utilizados (clase E1 según el DM 10/10/2008). Los productos certificados por FSC® (Código de Licencia FSC-C118323) están disponibles bajo solicitud: por favor contacte a nuestras oficinas para más información. (Imagen 2)

**LEED:** El sistema A65 puede contribuir a la consecución de la puntuación de certificación LEED para los créditos indicados en los product badges. (Imagen 3)

**Sistemas de Gestión Certificados ISO 9001, ISO 14001, ISO 45001:** Alea está comprometida activamente en alcanzar altos estándares de calidad y responsabilidad mediante la adopción de sistemas de gestión certificados por ISO para garantizar productos y servicios de alta calidad, que cumplen con las expectativas de los clientes, aseguran un entorno de trabajo seguro y monitorean regularmente el impacto ambiental de nuestras actividades. (Imagen 4)

**Certificación de Producto:** Los productos Alea han sido sometidos a pruebas de rendimiento en laboratorios acreditados. Las copias de los informes de prueba o los certificados de conformidad están disponibles bajo solicitud. (Imagen 5)



1.



2.



3.



4.



5.



**concept & design**

Alea marketing + communication

**art director**

Mirto Antonel

**product design**

Mirto Antonel

AF/CACD/AF

**Le immagini dei prodotti visibili all'interno di questo catalogo sono inserite a scopo puramente indicativo**

The images of the products visible in this catalogue are included for information purposes only  
Les images des produits visibles dans ce catalogue sont incluses à titre informatif uniquement  
Las imágenes de los productos visibles en este catálogo se incluyen sólo con fines informativos

**alea**  
aleaoffice.com



**GLOBAL HEADQUARTERS AND SHOWROOM** : Via Col de Rust, 19 - 33070 Sarone (PN) - Italia : Tel ++39 0434 777 333  
email: info@aleaoffice.com **PARIS SHOWROOM** : 176 Avenue Charles de Gaulle 92200, Neuilly-sur-Seine - France **NORTH AMERICAN**  
**HEADQUARTERS** : Midtown 2, 3449 NE 1st Avenue L-32, Miami, FL 33137 - USA : Tel ++1 305 470 1200 - email: info@alea-usa.com  
**ALEA UK OFFICE AND SHOWROOM** : 50-54 Clerkenwell Road, London EC1M 5PS - email: info@aleaoffice.com