

# alea

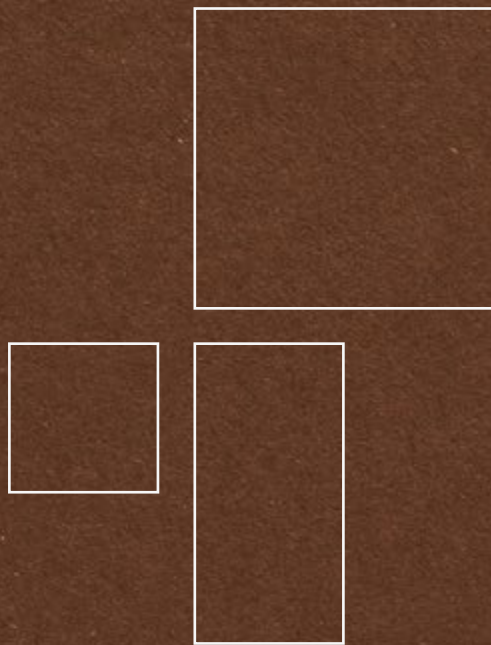

## F40

---

phone booths + pods

# Lo spazio assume nuove funzioni

F40 è la collezione di cabine progettate per ricavare angoli di privacy e comfort

Space takes on new functions. F40 is the collection of phone booths and pods designed to create corners of privacy and comfort.

El espacio adquiere nuevas funciones. F40 es la colección de cabinas, diseñadas para crear rincones de intimidad y confort.

L'espace adopte de nouvelles fonctions. F40 est la collection de box acoustiques conçue pour créer des coins d'intimité et de confort.



call



relax



meet







Negli spazi ampi nasce il bisogno di isolarsi per una chiamata oppure un meeting privato, o più semplicemente per ricavarsi un momento di maggiore concentrazione. La collezione di cabine F40 nasce proprio per rispondere a queste esigenze. Si distingue per il design lineare e la rapidità di assemblaggio in cantiere, con conseguente abbattimento dei costi per il cliente.

F40 si presenta in 5 dimensioni che possono accogliere da 1 fino a 8 persone e dove si possono allestire sia gli interni che gli esterni con diverse tipologie di accessori che vanno dal supporto per dispositivi video all'arredo integrato, fino ad arrivare a soluzioni estetiche per l'acustica. Su F40 è possibile addirittura l'applicazione di grafiche alle superfici verticali esterne permettendo così una vera e propria personalizzazione a 360°.

In large spaces there is a need to isolate oneself for a call or a private meeting, or simply to find a moment of greater concentration. The F40 pods and phone booths collection was created to meet these needs. It stands out for its linear design and rapidity of assembly on site, with consequent reduction of costs for the customer.

F40 is available in 5 sizes that can accommodate from 1 up to 8 people. Interiors and exteriors can be outfitted with different types of accessories ranging from TV supports, integrated furniture, to aesthetic solutions for acoustics. External panels can also be personalized using client graphics, allowing a true 360-degree customization.



one  
two  
four  
six  
eight



Dans les grands espaces, il est nécessaire de s'isoler pour un appel ou une réunion privée, ou simplement pour trouver un moment de plus grande concentration. La collection de pods et cabines F40 a été créée pour répondre à ces besoins. Ils se distinguent par leur conception linéaire et leur rapidité de montage sur site, avec une réduction conséquente des coûts pour le client.

F40 se décline en 5 tailles pouvant accueillir de 1 à 8 personnes et où les intérieurs et les extérieurs peuvent être aménagés avec différents types d'accessoires allant du support pour appareils vidéo aux meubles intégrés, jusqu'aux solutions esthétiques pour l'acoustique. Sur le F40, il est même possible d'appliquer des graphismes sur les surfaces verticales externes, permettant ainsi une véritable personnalisation à 360°.

En los grandes espacios nace la necesidad de aislarse para una llamada o una reunión privada, o simplemente para buscar un momento de mayor concentración. La colección de cabinas F40 se ha creado para satisfacer estas necesidades. Destaca por su diseño lineal y la rapidez de montaje en obra, con la consiguiente reducción de costes para el cliente.

F40 se presenta en 5 tamaños que pueden alojar desde 1 hasta 8 personas, y donde, tanto el interior como el exterior, pueden equiparse con distintos tipos de accesorios: soportes para dispositivos de vídeo y mobiliario integrado, así como soluciones estéticas para la acústica. En F40 es posible incluso aplicar gráficos a las superficies verticales exteriores, permitiendo así una verdadera personalización a 360°.





G Men Shoes



What to do?

~~UX~~  
% Satisfaction

Impacts!  
Design

BALANCED  
LAYOUT

#E2DE06  
DFD031

10/9

What do they want?

- Sneakers?
- Search?
- Dress shoes?
- .....
- A way to buy?
- Privacy Policy?
- Phone number?



/ONE

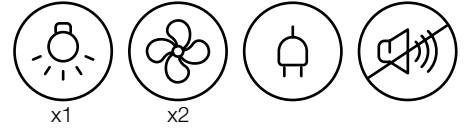

**Accessori**  
Accessories  
Accessoires  
Accesorios

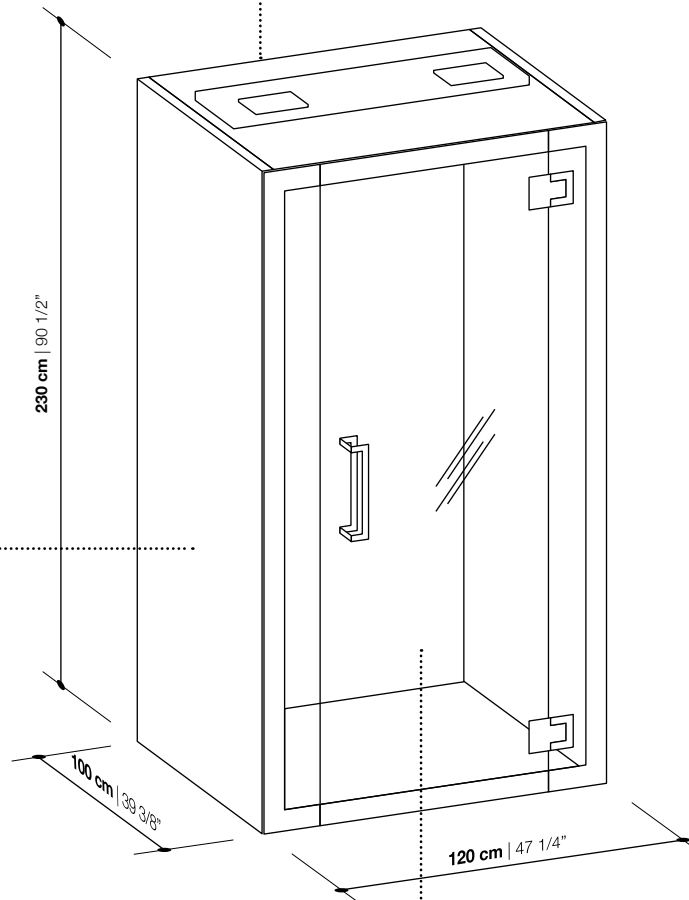
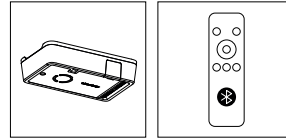

**Accessori esterni**  
External accessories  
Accessoires externes  
Accesorios externos

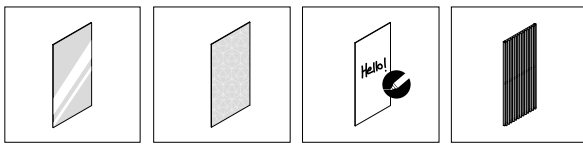

Side Side/Back Back Side

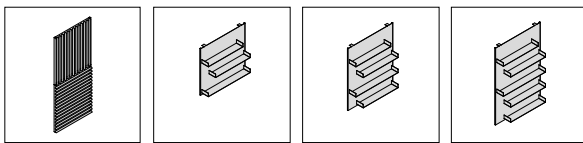

Side Side/Back Side/Back Side/Back

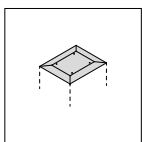

Top

**Arredo interno**  
Interior furniture  
Mobilier intérieur  
Mobiliario interior

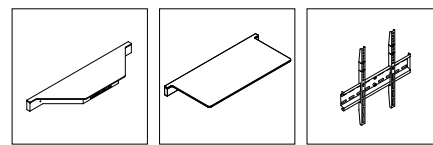

Side Side Side





**Cablaggio integrato (12 Volt)**  
Integrated wiring (12 Volt)  
Câblage intégré (12 Volt)  
Cableado integrado (12 Volt)

**Flusso d'aria in entrata**  
Incoming air flow  
Flux d'air entrant  
Flujo de aire de entrada

**Flusso d'aria in uscita**  
Outgoing air flow  
Flux d'air sortant  
Flujo de aire de salida



**Luce LED con sensore di movimento**  
LED light with motion sensor  
LED avec détecteur de mouvement  
Luz LED con detector de movimiento



**Sanificatore (opzionale)**  
Air sanitiser (optional)  
Purificateur d'air (optionnel)  
Purificador de aire (opcional)



**Prese elettriche (opzionale)**  
Power socket (optional)  
Prises électriques (optionnel)  
Tomas eléctricas (opcional)



**Ventilazione integrata con sensore di movimento**  
Integrated ventilation system with motion sensor  
Ventilation intégrée avec détecteur de mouvement  
Ventilación integrada con sensor de movimiento



**Supporto TV (opzionale)**  
TV support (optional)  
Support écran TV (optionnel)  
Soporte de TV (opcional)



**Input elettrico**  
Electric input  
Entrée électrique  
Entrada eléctrica



**/TWO**

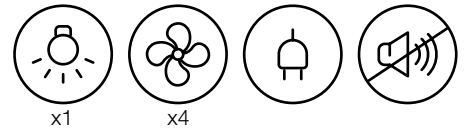

**Accessori**  
Accessories  
Accessoires  
Accesorios

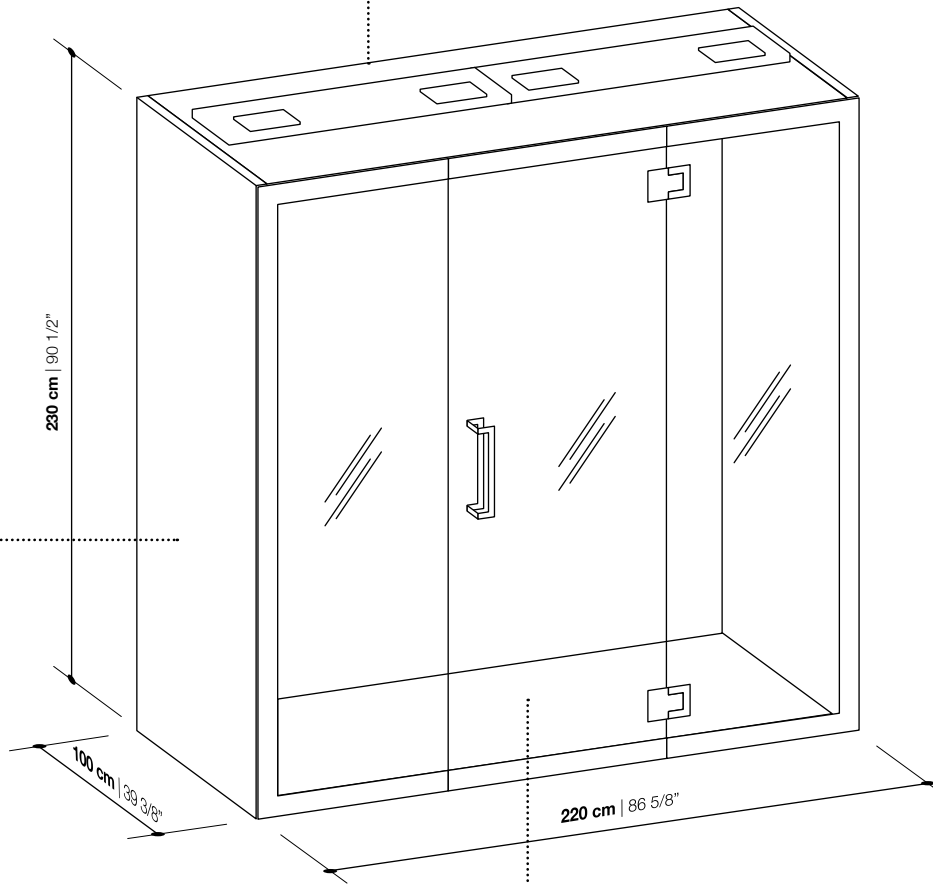
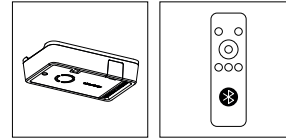

**Accessori esterni**  
External accessories  
Accessoires externes  
Accesorios externos

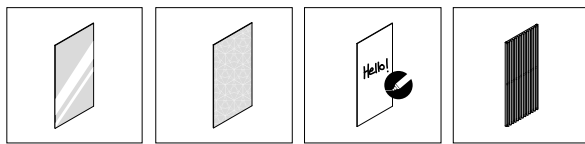

Side Side/Back Back Side

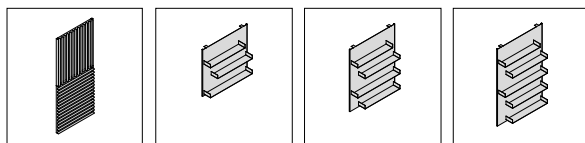

Side Side/Back Side/Back Side/Back

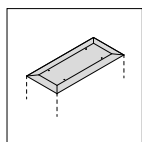

Top

**Arredo interno**  
Interior furniture  
Mobilier intérieur  
Mobiliario interior

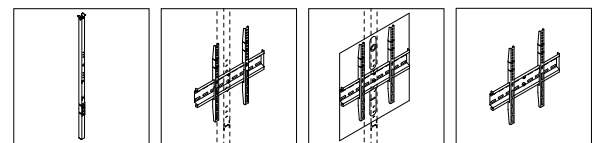

Back Back Back Side

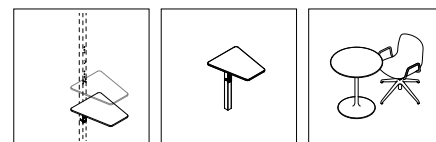

Back Back





**Cablaggio integrato (12 Volt)**  
Integrated wiring (12 Volt)  
Câblage intégré (12 Volt)  
Cableado integrado (12 Volt)

**Flusso d'aria in entrata**  
Incoming air flow  
Flux d'air entrant  
Flujo de aire de entrada

**Flusso d'aria in uscita**  
Outgoing air flow  
Flux d'air sortant  
Flujo de aire de salida



**Luce LED con sensore di movimento**  
LED light with motion sensor  
LED avec détecteur de mouvement  
Luz LED con detector de movimiento



**Sanificatore (opzionale)**  
Air sanitiser (optional)  
Purificateur d'air (optionnel)  
Purificador de aire (opcional)



**Prese elettriche (opzionale)**  
Power socket (optional)  
Prises électriques (optionnel)  
Tomas eléctricas (opcional)



**Ventilazione integrata con sensore di movimento**  
Integrated ventilation system with motion sensor  
Ventilation intégrée avec détecteur de mouvement  
Ventilación integrada con sensor de movimiento



**Supporto TV (opzionale)**  
TV support (optional)  
Support écran TV (optionnel)  
Soporte de TV (opcional)



**Input elettrico**  
Electric input  
Entrée électrique  
Entrada eléctrica



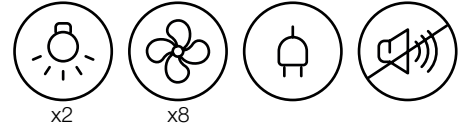

**Accessori**  
Accessories  
Accessoires  
Accesorios

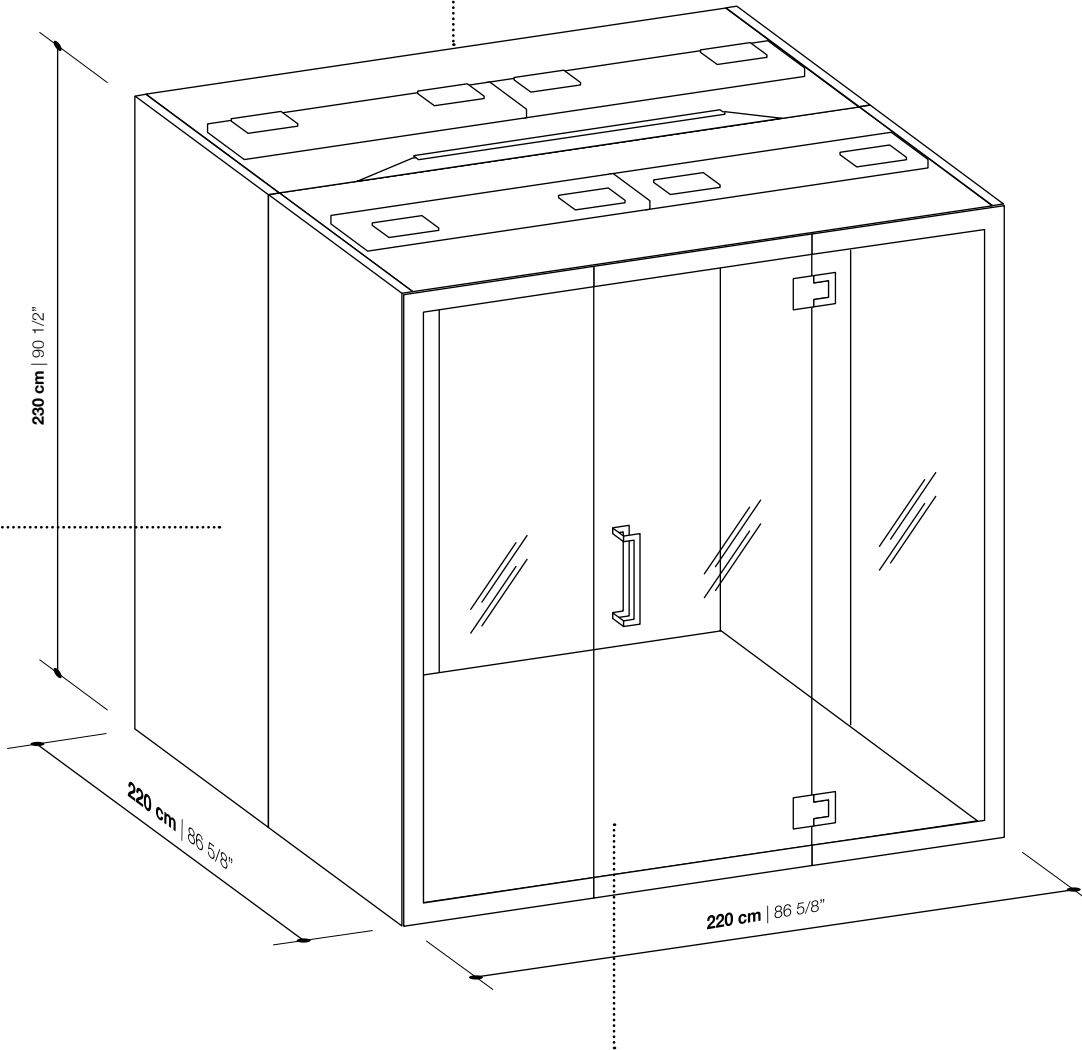
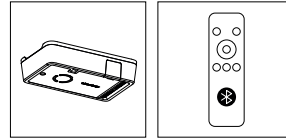

**Accessori esterni**  
External accessories  
Accessoires externes  
Accesorios externos

**Arredo interno**  
Interior furniture  
Mobilier intérieur  
Mobiliario interior

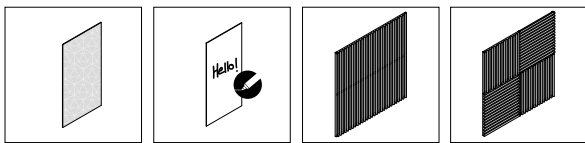

Side/Back      Back      Side      Side

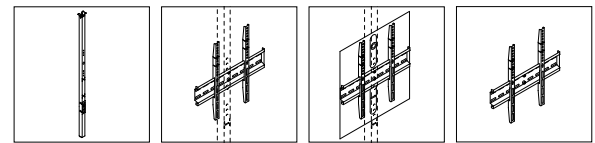

Side/Back      Side/Back      Back      Side

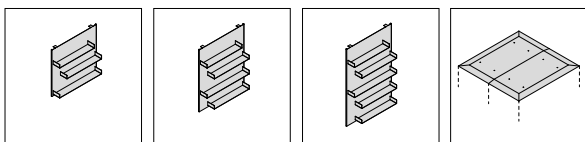

Side/Back      Side/Back      Side/Back      Top

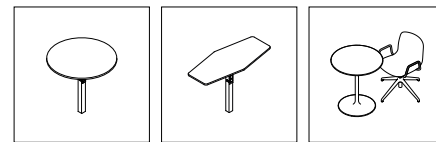

Centre      Centre



**Cablaggio integrato (24 Volt)**  
Integrated wiring (24 Volt)  
Câblage intégré (24 Volt)  
Cableado integrado (24 Volt)

**Flusso d'aria in entrata**  
Incoming air flow  
Flux d'air entrant  
Flujo de aire de entrada

**Flusso d'aria in uscita**  
Outgoing air flow  
Flux d'air sortant  
Flujo de aire de salida

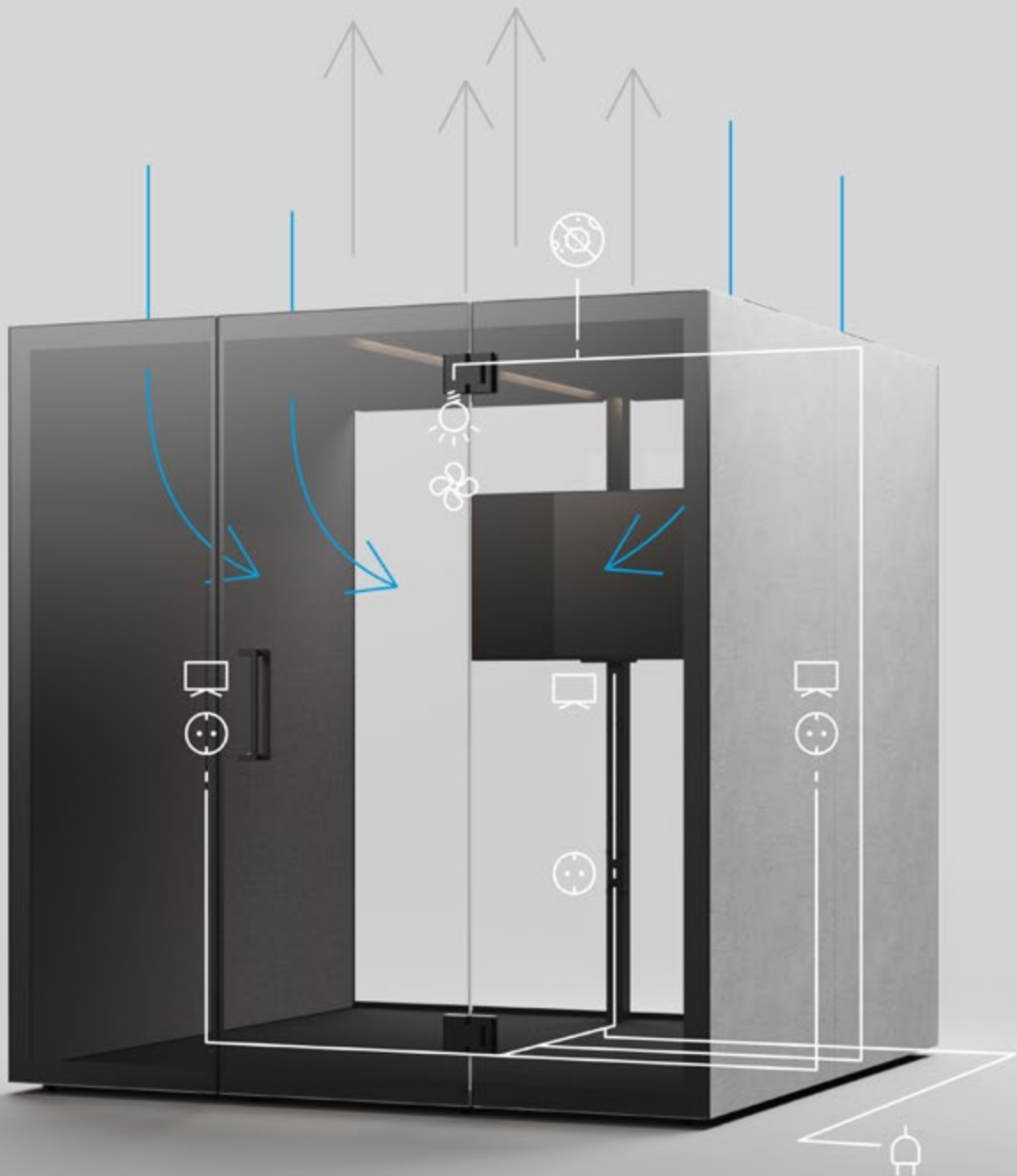

**Luce LED con sensore di movimento**  
LED light with motion sensor  
LED avec détecteur de mouvement  
Luz LED con detector de movimiento



**Sanificatore (opzionale)**  
Air sanitiser (optional)  
Purificateur d'air (optionnel)  
Purificador de aire (opcional)



**Prese elettriche (opzionale)**  
Power socket (optional)  
Prises électriques (optionnel)  
Tomas eléctricas (opcional)



**Ventilazione integrata con sensore di movimento**  
Integrated ventilation system with motion sensor  
Ventilation intégrée avec détecteur de mouvement  
Ventilación integrada con sensor de movimiento



**Supporto TV (opzionale)**  
TV support (optional)  
Support écran TV (optionnel)  
Soporte de TV (opcional)



**Input elettrico**  
Electric input  
Entrée électrique  
Entrada eléctrica



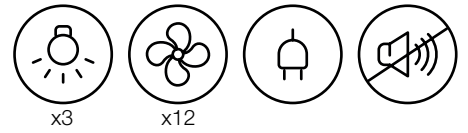

**Accessori**  
Accessories  
Accessoires  
Accesorios

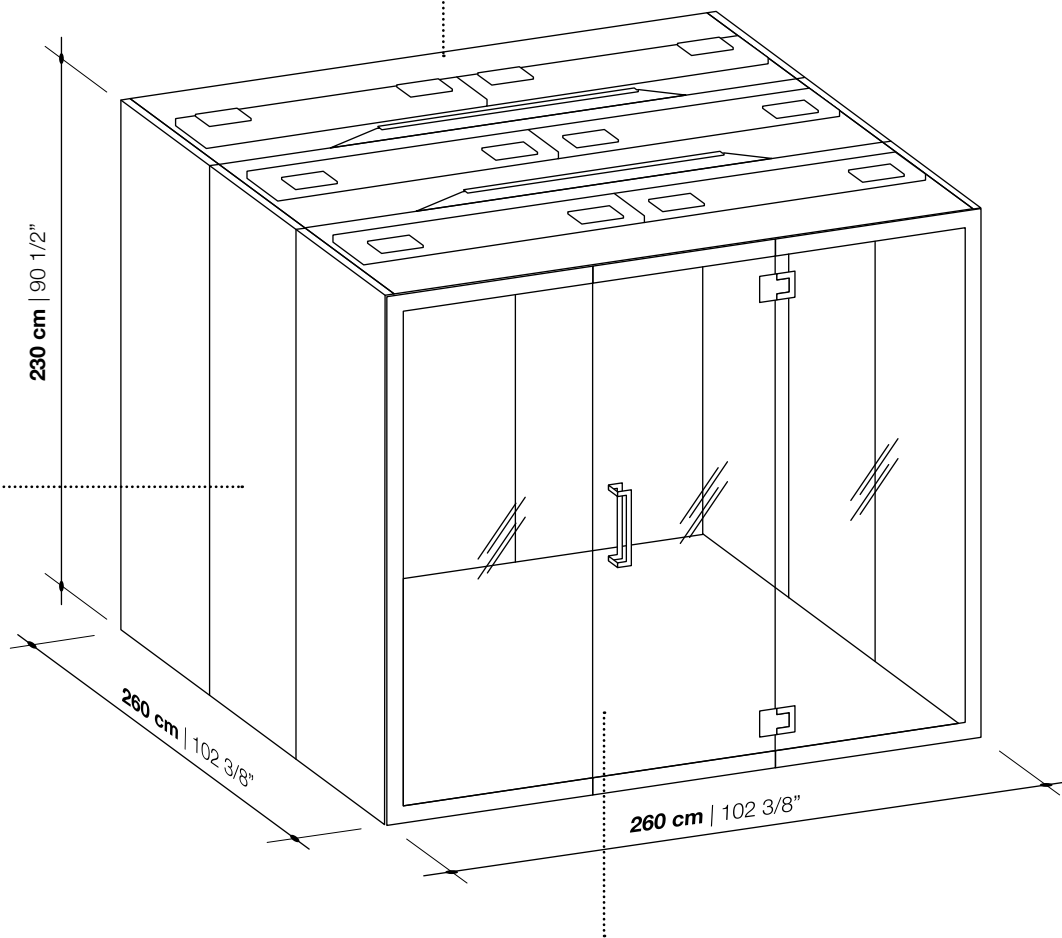
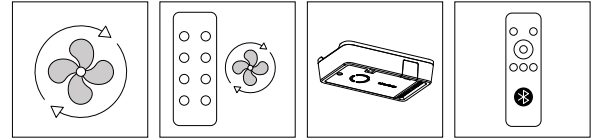

**Accessori esterni**  
External accessories  
Accessoires externes  
Accesorios externos

**Arredo interno**  
Interior furniture  
Mobilier intérieur  
Mobiliario interior

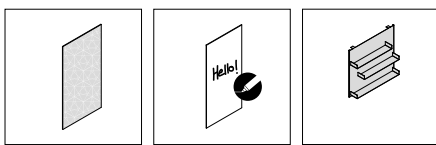

Side/Back      Back      Side/Back

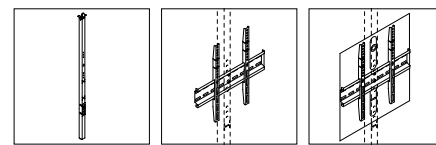

Side/Back      Side/Back      Back

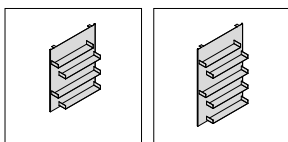

Side/Back      Side/Back

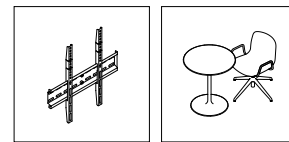

Side





**Cablaggio integrato (24 Volt)**  
Integrated wiring (24 Volt)  
Câblage intégré (24 Volt)  
Cableado integrado (24 Volt)

**Flusso d'aria in entrata**  
Incoming air flow  
Flux d'air entrant  
Flujo de aire de entrada

**Flusso d'aria in uscita**  
Outgoing air flow  
Flux d'air sortant  
Flujo de aire de salida

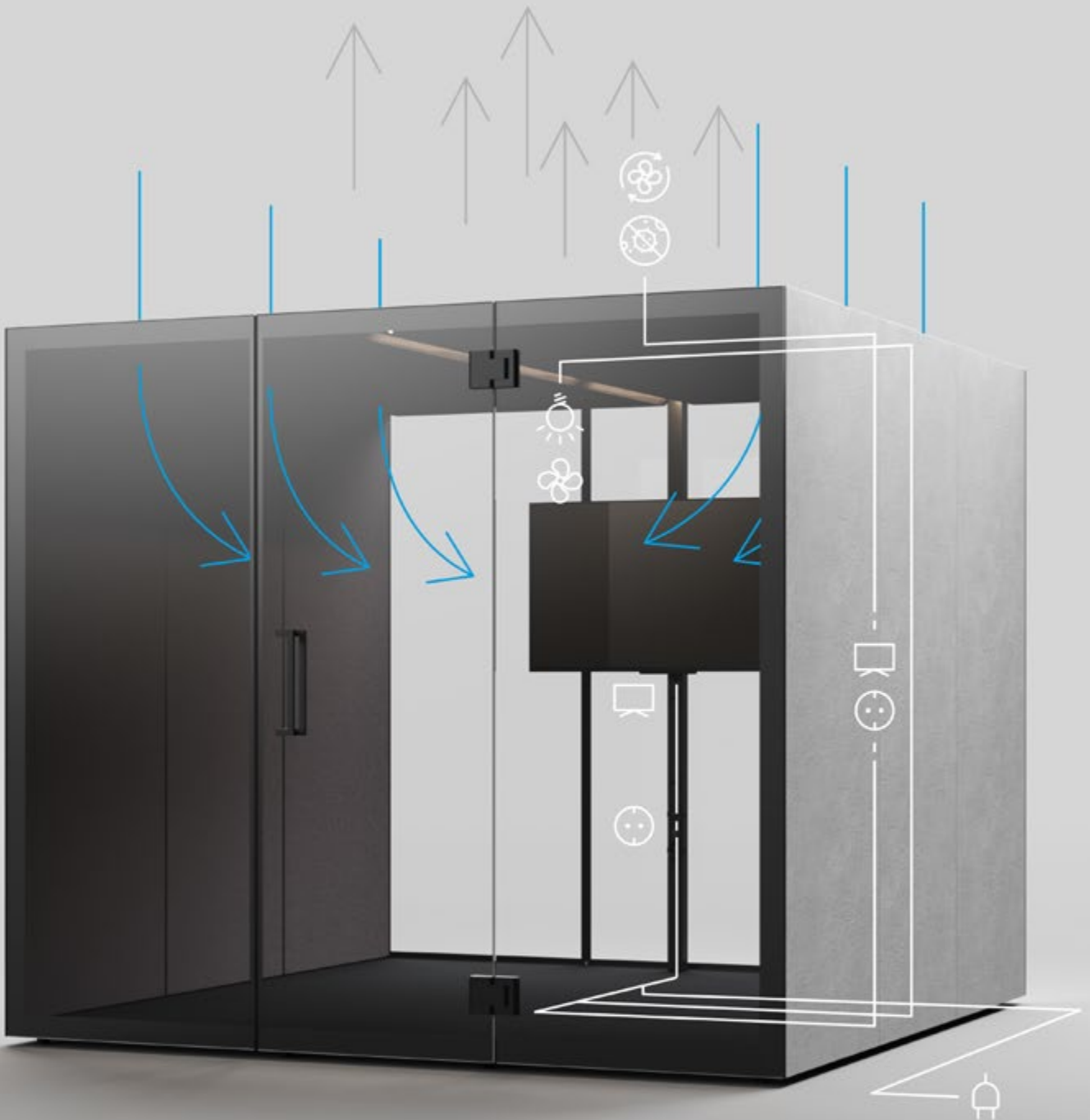

**Luce LED con sensore di movimento**  
LED light with motion sensor  
LED avec détecteur de mouvement  
Luz LED con detector de movimiento



**Sanificatore (opzionale)**  
Air sanitiser (optional)  
Purificateur d'air (optionnel)  
Purificador de aire (opcional)



**Prese elettriche (opzionale)**  
Power socket (optional)  
Prises électriques (optionnel)  
Tomas eléctricas (opcional)



**Ventilazione integrata con sensore di movimento**  
Integrated ventilation system with motion sensor  
Ventilation intégrée avec détecteur de mouvement  
Ventilación integrada con sensor de movimiento



**Supporto TV (opzionale)**  
TV support (optional)  
Support écran TV (optionnel)  
Soporte de TV (opcional)



**Input elettrico**  
Electric input  
Entrée électrique  
Entrada eléctrica



**Ventilazione meccanica forzata (opzionale)**  
Mechanical forced ventilation (optional)  
Ventilation mécanique contrôlée (optionnel)  
Ventilación mecánica forzada (opcional)



/EIGHT

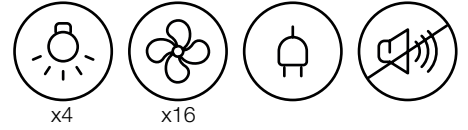

**Accessori**  
Accessories  
Accessoires  
Accesorios

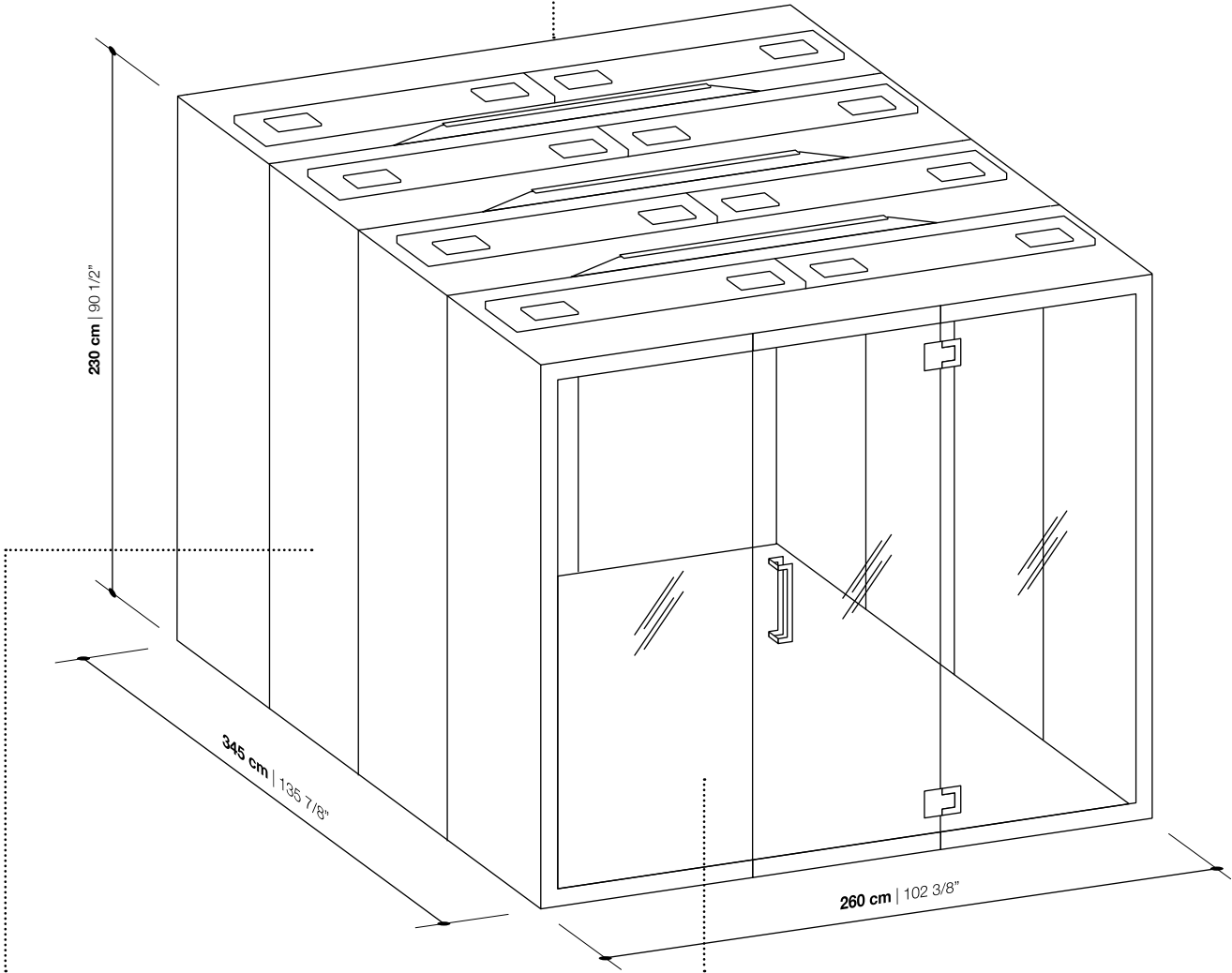
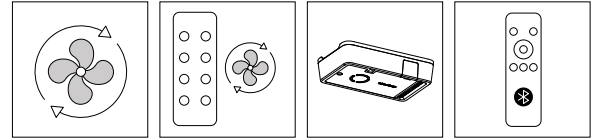

**Accessori esterni**  
External accessories  
Accessoires externes  
Accesorios externos

**Arredo interno**  
Interior furniture  
Mobilier intérieur  
Mobiliario interior

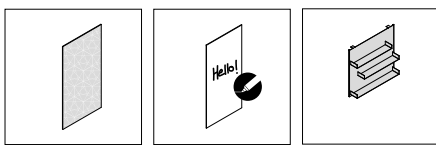

Side/Back

Back

Side/Back

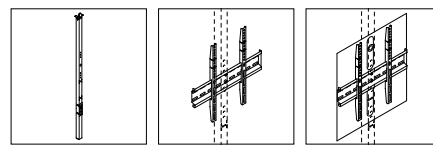

Back

Back

Back

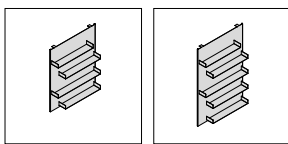

Side/Back

Side/Back

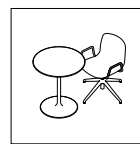



**Cablaggio integrato (24 Volt)**  
Integrated wiring (24 Volt)  
Câblage intégré (24 Volt)  
Cableado integrado (24 Volt)

**Flusso d'aria in entrata**  
Incoming air flow  
Flux d'air entrant  
Flujo de aire de entrada

**Flusso d'aria in uscita**  
Outgoing air flow  
Flux d'air sortant  
Flujo de aire de salida

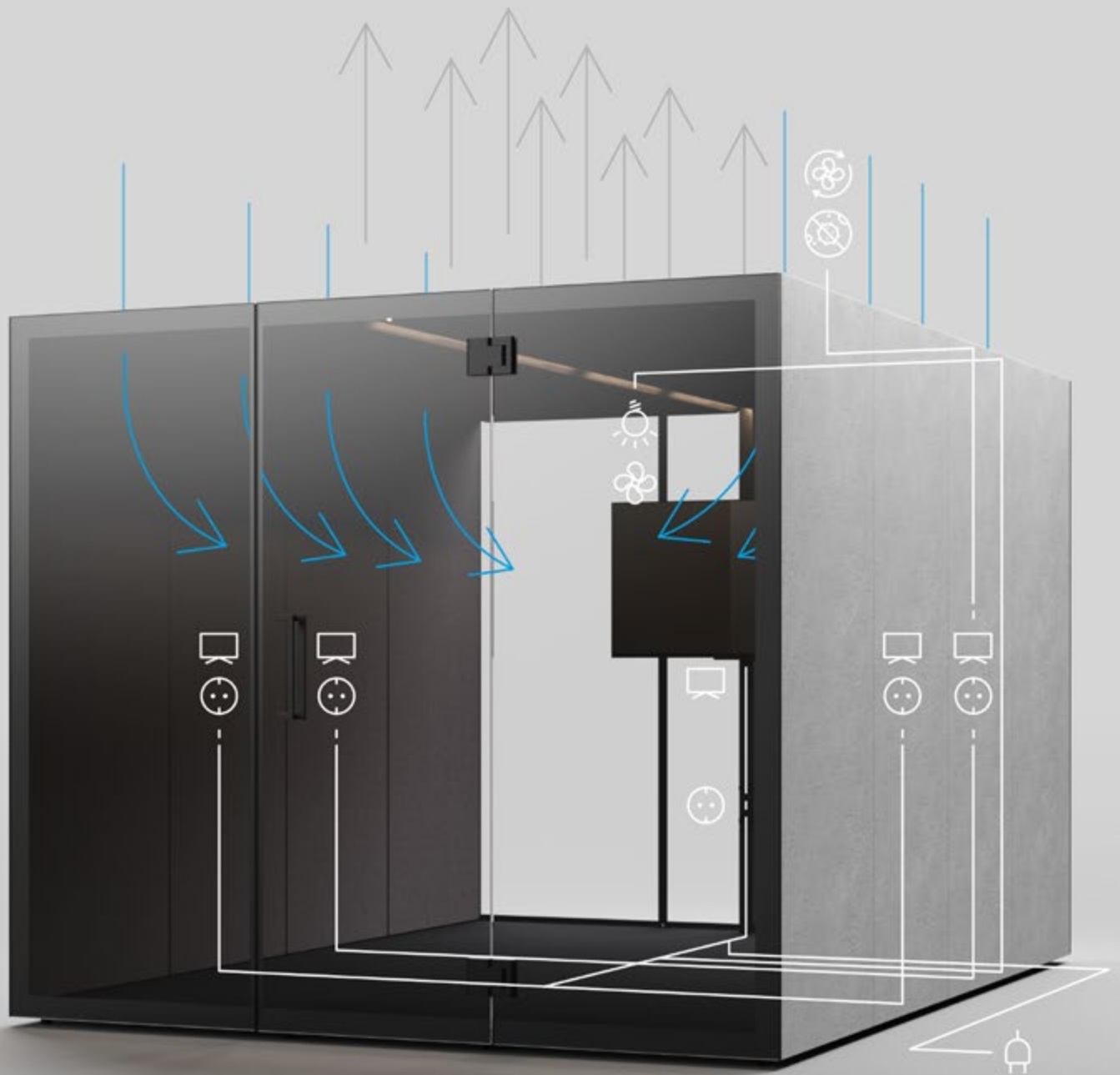

**Luce LED con sensore di movimento**  
LED light with motion sensor  
LED avec détecteur de mouvement  
Luz LED con detector de movimiento



**Sanificatore (opzionale)**  
Air sanitiser (optional)  
Purificateur d'air (optionnel)  
Purificador de aire (opcional)



**Prese elettriche (opzionale)**  
Power socket (optional)  
Prises électriques (optionnel)  
Tomas eléctricas (opcional)



**Ventilazione integrata con sensore di movimento**  
Integrated ventilation system with motion sensor  
Ventilation intégrée avec détecteur de mouvement  
Ventilación integrada con sensor de movimiento



**Supporto TV (opzionale)**  
TV support (optional)  
Support écran TV (optionnel)  
Soporte de TV (opcional)



**Input elettrico**  
Electric input  
Entrée électrique  
Entrada eléctrica



**Ventilazione meccanica forzata (opzionale)**  
Mechanical forced ventilation (optional)  
Ventilation mécanique contrôlée (optionnel)  
Ventilación mecánica forzada (opcional)

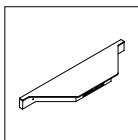

**Mensola con prese integrate**  
Shelf with integrated power module  
Etagère avec prises intégrées  
Estante con enchufes integrados

ONE

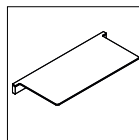

**Mensola con prese integrate**  
Shelf with integrated power module  
Etagère avec prises intégrées  
Estante con enchufes integrados

ONE



H 73,4 | 105 cm  
H 28 7/8" | 41 3/8"



H 73,4 | 105 cm  
H 28 7/8" | 41 3/8"



H 73,4 | 105 cm  
H 28 7/8" | 41 3/8"

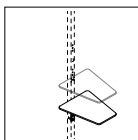

**Tavolo regolabile in 2 posizioni**  
2-position adjustable table  
Table réglable en 2 positions  
Mesa regulable en 2 posiciones

TWO

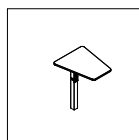

**Tavolo a trapezio, prese integrate**  
Trapezoidal table, integrated power module  
Table trapézoïdale, prises intégrées  
Mesa trapezoidal, enchufes integrados

TWO

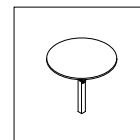

**Tavolo rotondo, prese integrate**  
Round table, integrated power module  
Table ronde, prises intégrées  
Mesa redonda, enchufes integrados

FOUR



H 73,4 | 105 cm  
H 28 7/8" | 41 3/8"

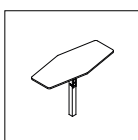

**Tavolo esagonale, prese integrate**  
Hexagonal table, integrated power module  
Table hexagonale, prises intégrées  
Mesa hexagonal, enchufes integrados

FOUR

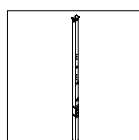

**Colonna tecnica con prese integrate**  
Column with integrated power module  
Colonne avec prises intégrées  
Columna con enchufes integrados

TWO / FOUR / SIX / EIGHT

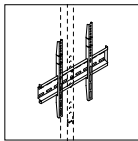

**Supporto TV per schiena melaminico**  
TV support for melamine back  
Support TV pour fond en mélaminé  
Soporte de TV para trasera en melamina

TWO / FOUR / SIX / EIGHT

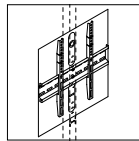

**Supporto TV per schiena vetro**  
TV support for glass back  
Support TV pour fond en verre  
Soporte de TV para trasera en vidrio

TWO / FOUR / SIX / EIGHT

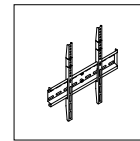
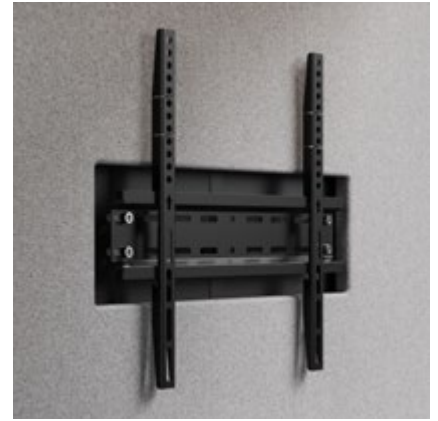

**Supporto TV integrato**  
Integrated TV support  
Support écran TV intégré  
Soporte para TV integrado

ONE / TWO / FOUR / SIX

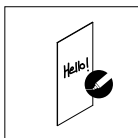

**Schiena scrivibile**  
Writable back  
Fond inscriptible  
Trasera escribible

ONE / TWO / FOUR / SIX / EIGHT

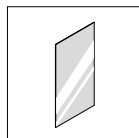

**Specchio per fianco**  
Side mirror  
Miroir pour coté  
Espejo para costado

ONE / TWO

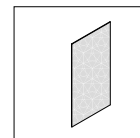

**Stampa UV**  
UV print  
Impression UV  
Impresión UV

ONE / TWO / FOUR / SIX / EIGHT

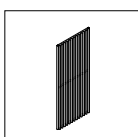
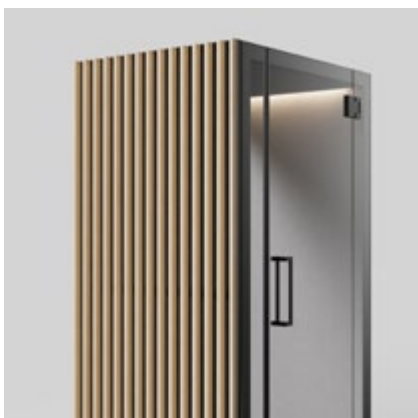

**Pannelli acustici con doghe verticali**  
Acoustic panels with vertical planks  
Panneaux insonorisants, planches verticales  
Paneles acústicos con lamas verticales

ONE / TWO / FOUR

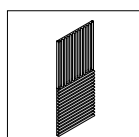

**Pannelli acustici con doghe miste**  
Acoustic panels with mixed planks  
Panneaux insonorisants, planches mixtes  
Paneles acústicos con lamas mixtas

ONE / TWO / FOUR

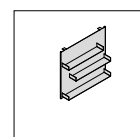

**Elemento con 3 mensole**  
Element with 3 shelves  
Élément avec 3 étagères  
Elemento con 3 estantes

ONE / TWO / FOUR / SIX / EIGHT

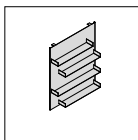

**Elemento con 4 mensole**  
 Element with 4 shelves  
 Élément avec 4 étagères  
 Elemento con 4 estantes

ONE / TWO / FOUR / SIX / EIGHT

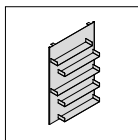

**Elemento con 5 mensole**  
 Element with 5 shelves  
 Élément avec 5 étagères  
 Elemento con 5 estantes

ONE / TWO / FOUR / SIX / EIGHT

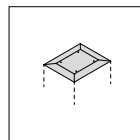

**Top di copertura**  
 Covering top  
 Dessus  
 Cubierta superior

ONE / TWO / FOUR

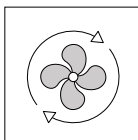

**Ventilazione meccanica forzata**  
 Mechanical forced ventilation  
 Ventilation mécanique contrôlée  
 Ventilación mecánica forzada

SIX / EIGHT

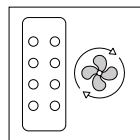

**Telecomando per ventilazione forzata**  
 Remote for forced ventilation  
 Télécommande pour ventilation contrôlée  
 Mando a distancia para ventilación forzada

SIX / EIGHT

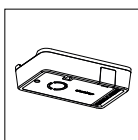

**Sanificatore d'aria**  
 Air sanitiser  
 Purificateur d'air  
 Purificador de aire

ONE / TWO / FOUR / SIX / EIGHT

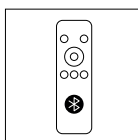

**Dimmer per illuminazione e ventilazione**  
 Lighting and ventilation dimmer  
 Dimmer pour illumination et ventilation  
 Dimmer para iluminación y ventilación

ONE / TWO / FOUR / SIX / EIGHT



Go to our website and configure now



or find us on **pCon**

1

TY  
INATION  
RE

46" S 354" 28" 24" E





# Finiture | Finishes | Finitions | Acabados

## MEL

### Melaminico

Melamine | Mélaminé | Melamínico

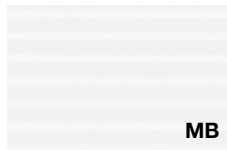

MB

**Bianco rigato**  
Rippled effect white  
Blanc avec rayures en sérigraphie  
Blanco rayado

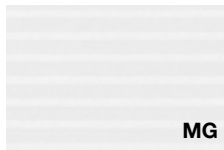

MG

**Grigio rigato**  
Rippled effect grey  
Gris avec rayures en sérigraphie  
Gris rayado



MF

**Nichel**  
Nickel  
Nickel  
Níquel



MZ

**Cacao**  
Cocoa  
Cacao  
Cacao

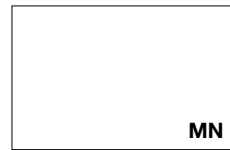

MN

**Bianco**  
White  
Blanc  
Blanco

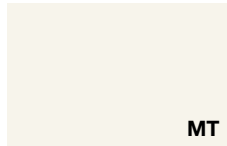

MT

**Talco**  
Talco  
Talco  
Talco



MJ

**Ocre**  
Ochre  
Ocre  
Ocre



MH

**Terracotta**  
Terracotta  
Terre cuite  
Terracota



MK

**Safari**  
Safari  
Safari  
Safari



MI

**Noisette**  
Noisette  
Noisette  
Noisette



MV

**Verde**  
Green  
Vert  
Verde



ML

**Nero**  
Black  
Noir  
Negro



MQ

**Blu notte**  
Night blue  
Bleu nuit  
Azul noche

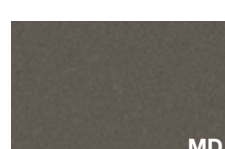

MD

**Ardesia**  
Ardesia  
Ardesia  
Pizarra

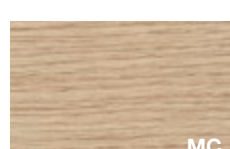

MC

**Rovere chiaro**  
Light oak  
Chêne clair  
Roble claro

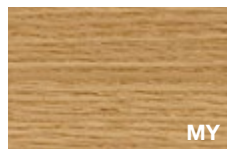

MY

**Rovere americano**  
American oak  
Chêne américain  
Roble americano



ME

**Rovere grigio**  
Grey oak  
Chêne gris  
Roble gris



MM

**Rovere moro**  
Dark oak  
Chêne foncé  
Roble oscuro

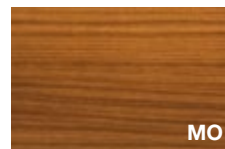

MO

**Noce Canaletto**  
Canaletto Walnut  
Noyer Canaletto  
Nogal Canaletto

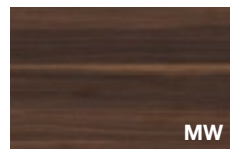

MW

**Noce scuro**  
Dark walnut  
Noyer foncé  
Nogal oscuro

## **TES**

### **Tessuto**

Fabric | Tissu | Tejido



**Beige**  
Beige  
Beige  
Beige

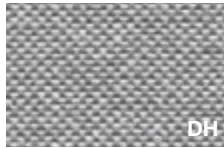

**Grigio chiaro**  
Light grey  
Gris clair  
Gris claro



**Ardesia**  
Ardesia  
Ardesia  
Pizarra



**Blu avio**  
Avio blue  
Bleu avio  
Azul avio



**Acquamarina**  
Aquamarine  
Aigue-marine  
Aguamarina



**Verde primavera**  
Spring green  
Vert printemps  
Verde primavera



**Salvia**  
Sage  
Sauge  
Salvia



**Arancio**  
Orange  
Orange  
Naranja



**Corallo**  
Coral  
Corail  
Coral

## **MOQ**

### **Moquette**

Carpet | Moquette | Moqueta

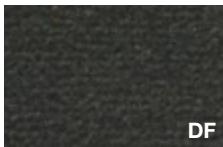

**Grigio**  
Gray  
Gris  
Gris

**Le finiture contenute nella stampa sono puramente indicative e non sono di riferimento per le forniture del prodotto**

Due to the printing process, finishes shown in this document are for illustration only. The finish on the final item may differ slightly from the printed illustration  
Les finitions contenues dans l'impression sont purement indicatives et ne sont pas pertinentes pour les fournitures du produit  
Los acabados contenidos en la impresión son puramente indicativos y no son de referencia para los suministros del producto

# Ambiente e sicurezza | Environment and safety | Environnement et sécurité | Medio ambiente y seguridad

**Ecologia:** Alea utilizza per i suoi prodotti e i suoi imballi materiali facilmente separabili e riciclabili. (Immagine 1)

**Catena Di Custodia COC:** Alea si impegna ad utilizzare materiali legnosi certificati FSC® e pannelli a base di legno con certificazione CARB2.

I pannelli CARB2 presentano un rilascio di formaldeide inferiore rispetto al pannello E1 comunemente utilizzato (classe E1 secondo il DM 10/10/2008).

I prodotti certificati FSC ® (License Code FSC-C118323) sono disponibili su richiesta: contattate i nostri uffici per maggiori informazioni. (Immagine 2)

**LEED:** Gli arredi di Alea possono contribuire al conseguimento del punteggio di certificazione LEED per i crediti indicati nei product badge. (Immagine 3)

**Sistemi di Gestione certificati ISO 9001, ISO 14001, ISO 45001:** Alea è attivamente impegnata nel raggiungere standard elevati di qualità e responsabilità attraverso l'adozione di sistemi di gestione certificati ISO per garantire prodotti e servizi di elevata qualità, in grado di soddisfare le aspettative dei clienti, di assicurare un ambiente di lavoro sicuro e di monitorare regolarmente l'impatto ambientale delle nostre attività. (Immagine 4)

**Attestazione di prodotto:** I prodotti Alea sono stati sottoposti a prove prestazionali presso laboratori di prova accreditati.

Copia dei rapporti di prova o delle attestazioni di conformità sono disponibili su richiesta. (Immagine 5)

**Eco-friendly:** Alea uses easily separable and recyclable materials for its products and packaging. (Image 1)

**Chain of Custody (COC):** Alea is committed to using FSC® certified wood materials and CARB2-certified wood-based panels. CARB2 panels have lower formaldehyde emissions compared to the commonly used E1 panels (class E1 according to the DM 10/10/2008). FSC® certified products (License Code FSC-C118323) are available upon request: please contact our offices for more information. (Image 2)

**LEED:** The A65 system can contribute to obtaining LEED certification points for the credits indicated in the product badges. (Image 3)

**ISO 9001, ISO 14001, ISO 45001 Certified Management Systems:** Alea is actively committed to achieving high standards of quality and responsibility through the adoption of ISO certified management systems to ensure high-quality products and services that meet customer expectations, provide a safe working environment, and regularly monitor the environmental impact of our activities. (Image 4)

**Product Certification:** Alea products have undergone performance tests by accredited testing laboratories. Copies of test reports or certificates of conformity are available upon request. (Image 5)



# Ambiente e sicurezza | Environment and safety | Environnement et sécurité | Medio ambiente y seguridad

**Écologie:** Alea utilise pour ses produits et ses emballages des matériaux facilement séparables et recyclables. (Image 1)

**Chaîne de contrôle COC:** Alea a à cœur d'utiliser des matériaux en bois certifiés FSC® et des panneaux à base de bois avec la certification CARB2.

Les panneaux CARB2 présentent une émission de formaldéhyde inférieure à celle des panneaux E1 couramment utilisés (classe E1 selon le DM 10/10/2008). Les produits certifiés FSC® (Code de licence FSC-C118323) sont disponibles sur demande : veuillez contacter nos bureaux pour plus d'informations. (Image 2)

**LEED:** Le système A65 peut contribuer à l'obtention des points de certification LEED pour les crédits indiqués dans les badges produits. (Image 3)

**Systèmes de gestion certifiés ISO 9001, ISO 14001, ISO 45001:** Alea s'engage activement à atteindre des normes élevées de qualité et de responsabilité à travers l'adoption de systèmes de gestion certifiés ISO pour garantir des produits et services de haute qualité, répondre aux attentes des clients, assurer un environnement de travail sûr et surveiller régulièrement l'impact environnemental de nos activités. (Image 4)

**Attestation de produit:** Les produits Alea ont été soumis à des tests de performance dans des laboratoires d'essais accrédités. Des copies des rapports de tests ou des certificats de conformité sont disponibles sur demande. (Image 5)

**Ecología:** Alea utiliza para sus productos y embalajes materiales fácilmente separables y reciclables. (Imagen 1)

**Cadena de Custodia COC:** Alea se compromete a utilizar materiales de madera certificados por FSC® y paneles a base de madera con certificación CARB2.

Los paneles CARB2 presentan una emisión de formaldehído inferior en comparación con los paneles E1 comúnmente utilizados (clase E1 según el DM 10/10/2008). Los productos certificados por FSC® (Código de Licencia FSC-C118323) están disponibles bajo solicitud: por favor contacte a nuestras oficinas para más información. (Imagen 2)

**LEED:** El sistema A65 puede contribuir a la consecución de la puntuación de certificación LEED para los créditos indicados en los product badges. (Imagen 3)

**Sistemas de Gestión Certificados ISO 9001, ISO 14001, ISO 45001:** Alea está comprometida activamente en alcanzar altos estándares de calidad y responsabilidad mediante la adopción de sistemas de gestión certificados por ISO para garantizar productos y servicios de alta calidad, que cumplen con las expectativas de los clientes, aseguran un entorno de trabajo seguro y monitorean regularmente el impacto ambiental de nuestras actividades. (Imagen 4)

**Certificación de Producto:** Los productos Alea han sido sometidos a pruebas de rendimiento en laboratorios acreditados. Las copias de los informes de prueba o los certificados de conformidad están disponibles bajo solicitud. (Imagen 5)



1.



2.



3.



4.



5.

**Concept, visual & graphic design**

Alea marketing + communication

**Design**

Mirto Antonel

**Art direction**

Mirto Antonel

**Si ringrazia M.artedesign**

[martedesign.it](http://martedesign.it)

AD/CACD/AD

**Le immagini dei prodotti visibili all'interno di questo catalogo sono inserite a scopo puramente indicativo**  
The images of the products visible in this catalogue are included for information purposes only  
Les images des produits visibles dans ce catalogue sont incluses à titre informatif uniquement  
Las imágenes de los productos visibles en este catálogo se incluyen sólo con fines informativos



alea  
aleaoffice.com



**GLOBAL HEADQUARTERS AND SHOWROOM** : Via Col de Rust, 19 - 33070 Sarone (PN) - Italia : Tel ++39 0434 777 333  
email: info@aleaoffice.com **PARIS SHOWROOM** : 176 Avenue Charles de Gaulle 92200, Neuilly-sur-Seine - France **NORTH AMERICAN**  
**HEADQUARTERS** : Midtown 2, 3449 NE 1st Avenue L-32, Miami, FL 33137 - USA : Tel ++1 305 470 1200 - email: info@alea-usa.com  
**ALEA UK OFFICE AND SHOWROOM** : 50-54 Clerkenwell Road, London EC1M 5PS - email: info@aleaoffice.com