

alea

art | öilä
a portfolio a

portfolio

portfolio #3



portfolio #3

In- dex

10

Direzionali

Executive
Mobilièr de direction
Ejecutivos

76

Operativi

Workstations
Systèmes
Operativos

174

Receptions

Receptions
Accueils
Recepciones

190

Complementi

Complements
Compléments
Complementos

216

Librerie

Bookcases
Bibliothèques
Librerios

232

Contenitori

Cabinets
Rangements
Contenedores

266

Accessori

Accessories
Accessoires
Accesorios

272

Spazi

Spaces
Box & Cloisons
Espacios

296

Materiali e finiture

Materials and finishes
Matériels et finitions
Materiales y acabados

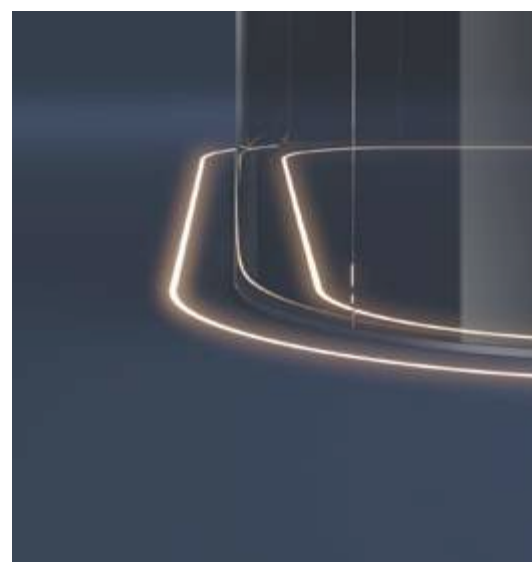
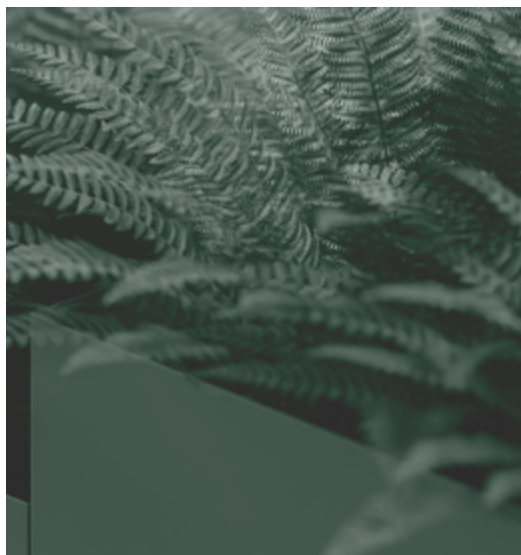
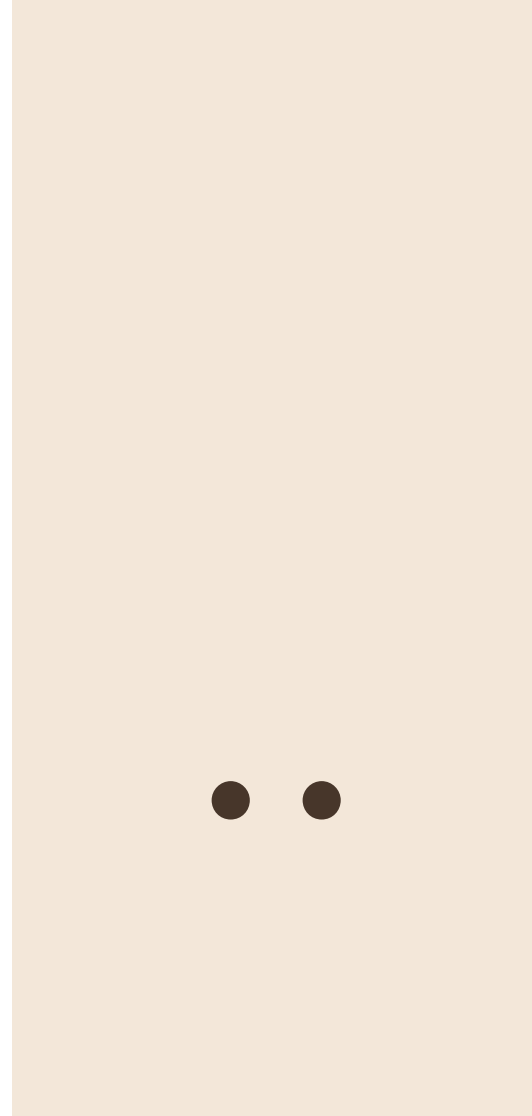

1972

HQ + Showroom
Italy



2001

HQ North America
Miami



2017

Showroom
London



2019

New corporate
image

alea

2021

Showroom
Paris



2022

50°
Anniversary



2023

Brand
acquisition

m | artedesign

2024

Showroom
Milan



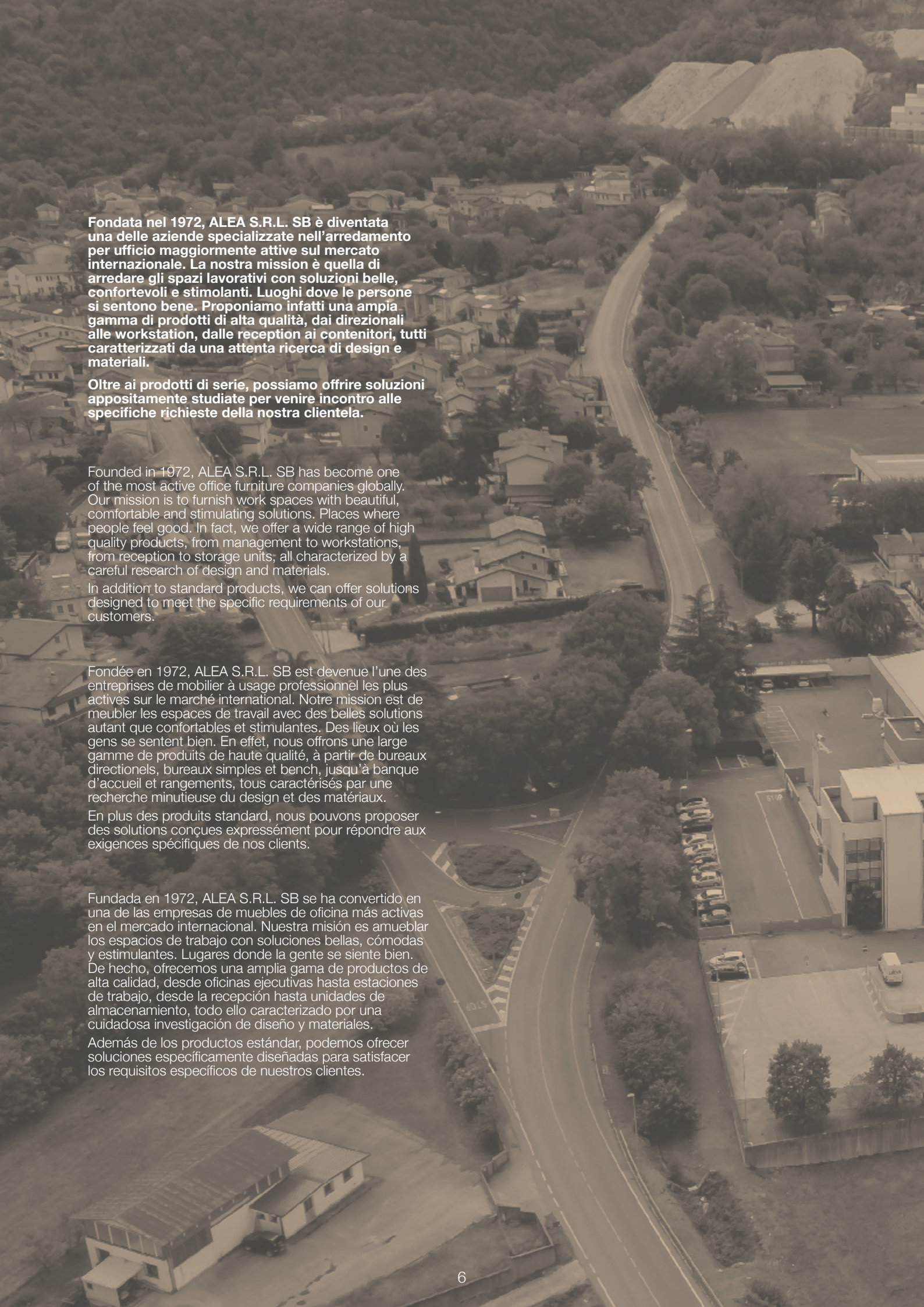

Fondata nel 1972, ALEA S.R.L. SB è diventata una delle aziende specializzate nell'arredamento per ufficio maggiormente attive sul mercato internazionale. La nostra mission è quella di arredare gli spazi lavorativi con soluzioni belle, confortevoli e stimolanti. Luoghi dove le persone si sentono bene. Proponiamo infatti una ampia gamma di prodotti di alta qualità, dai direzionali alle workstation, dalle reception ai contenitori, tutti caratterizzati da una attenta ricerca di design e materiali.

Oltre ai prodotti di serie, possiamo offrire soluzioni appositamente studiate per venire incontro alle specifiche richieste della nostra clientela.

Founded in 1972, ALEA S.R.L. SB has become one of the most active office furniture companies globally. Our mission is to furnish work spaces with beautiful, comfortable and stimulating solutions. Places where people feel good. In fact, we offer a wide range of high quality products, from management to workstations, from reception to storage units; all characterized by a careful research of design and materials.

In addition to standard products, we can offer solutions designed to meet the specific requirements of our customers.

Fondée en 1972, ALEA S.R.L. SB est devenue l'une des entreprises de mobilier à usage professionnel les plus actives sur le marché international. Notre mission est de meubler les espaces de travail avec des belles solutions autant que confortables et stimulantes. Des lieux où les gens se sentent bien. En effet, nous offrons une large gamme de produits de haute qualité, à partir de bureaux directionnels, bureaux simples et bench, jusqu'à banque d'accueil et rangements, tous caractérisés par une recherche minutieuse du design et des matériaux.

En plus des produits standard, nous pouvons proposer des solutions conçues expressément pour répondre aux exigences spécifiques de nos clients.

Fundada en 1972, ALEA S.R.L. SB se ha convertido en una de las empresas de muebles de oficina más activas en el mercado internacional. Nuestra misión es amueblar los espacios de trabajo con soluciones bellas, cómodas y estimulantes. Lugares donde la gente se siente bien. De hecho, ofrecemos una amplia gama de productos de alta calidad, desde oficinas ejecutivas hasta estaciones de trabajo, desde la recepción hasta unidades de almacenamiento, todo ello caracterizado por una cuidadosa investigación de diseño y materiales.

Además de los productos estándar, podemos ofrecer soluciones específicamente diseñadas para satisfacer los requisitos específicos de nuestros clientes.

INDUSTRIAL ARTISANS

La nostra mission è creare ambienti di lavoro belli, confortevoli e stimolanti. Luoghi dove le persone si sentono bene.

Our mission is to create beautiful, comfortable and inspiring office environments. Places where people feel good.
Notre mission est de créer des beaux espaces de travail, autant que confortables et stimulants. Des lieux où les gens se sentent à l'aise.
Nuestra misión es crear ambientes de trabajo bellos, cómodos y estimulantes. Lugares donde la gente se siente bien.

100%

Lavoriamo con un network strutturato di fornitori locali. I nostri prodotti sono 100% made in Italy.

We work with a strong network of local suppliers. Our products are 100% made in Italy.
Nous travaillons avec un réseau structuré de fournisseurs locaux. Nos produits sont fabriqués 100% en Italie.
Trabajamos con una red estructurada de proveedores locales. Nuestros productos son 100% made in Italy.

JUST IN TIME

La nostra produzione è basata sul sistema "just in time", la quale ci permette di offrire un'ampia gamma di prodotti riducendo al minimo gli sprechi.

Our production is based on a "just in time" system that allows us to offer a wide range of products while minimising waste.
Notre production est basée sur un système de "just in time" qui nous permet d'offrir une large gamme de produits tout en minimisant les déchets.
Nuestra producción se basa en un sistema "justo a tiempo" que nos permite ofrecer una amplia gama de productos minimizando los residuos.

90+

Siamo presenti in più di 90 paesi nel mondo.

We are present in more than 90 countries worldwide.
Nous sommes présents dans plus de 90 pays dans le monde.
Estamos presentes en más de 90 países del mundo.

Alea, diventata società benefit, crede fermamente nel business sostenibile ed è attenta all'impatto ambientale e alla salute dei lavoratori.

Il perseguimento di questi principi porta la nostra azienda a focalizzare gli sforzi sullo sviluppo eco-compatibile dei processi produttivi e dei prodotti finali. Infatti una delle nostre priorità è proprio la ricerca costante per l'utilizzo di materiali riciclabili.

Il conglomerato ligneo che viene impiegato per la produzione dei pannelli, rientra nella classe CARB P2 per le basse emissioni di formaldeide.

Le pareti divisorie e le porte possono contribuire al conseguimento del punteggio di certificazione LEED® V4 NC New Construction e LEED® V4 CI Commercial Interior per i seguenti crediti:

- Divulgazione e ottimizzazione dei prodotti edilizi, Approvvigionamento di materie prime
- Gestione dei rifiuti da costruzione e demolizione
- Riduzione dell'impatto del ciclo di vita degli interni (LEED ID+C)
- Materiali a bassa emissione
- Luce diurna
- Prestazioni acustiche.

Alea ha certificato il suo processo di qualità, in accordo con lo standard UNI EN ISO 9001 ed ha ottenuto il certificato UNI EN ISO 14001 per la gestione ambientale. Abbiamo inoltre certificato il sistema di gestione per la salute e la sicurezza in conformità alla UNI ISO 45001.

Su richiesta del cliente, Alea può fornire prodotti certificati FSC® (License Code FSC-C118323) secondo lo standard FSC-STD-40-004.

Sempre attenta alle iniziative ambientali, Alea garantisce per i suoi imballaggi l'utilizzo di cartone riciclato al 88% (marchiato Ecopack) e l'impiego di materiali riciclabili.

green



Alea, now a benefit company, firmly believes in sustainable business and is attentive to the environmental impact and workers' welfare. The pursuit of these principles leads our company to focus its efforts on the eco-friendly development of production processes and end products. In fact, one of our priorities is constant research into the use of recyclable materials.

The wood conglomerate that is used for the production of the panels, falls into the CARB P2 class for low formaldehyde emissions.

The partitions and doors can contribute to the LEED® V4 NC New Construction and LEED® V4 CI Commercial Interior certification score for the following credits:

- Disclosure and optimisation of building products, Procurement of raw materials
- Construction and demolition waste management
- Reducing the life cycle impact of interiors (LEED ID+C)
- Low-emission materials
- Daylighting
- Acoustic performance.

Alea has certified its quality process according to UNI EN ISO 9001 standard and obtained UNI EN ISO 14001 certificate for environmental management. We have also certified our health and safety management system in accordance with UNI ISO 45001.

Upon customer request, Alea can supply FSC® certified products (License Code FSC-C118323) according to FSC-STD-40-004 standard.

Always attentive to environmental initiatives, Alea guarantees for its packaging the use of 88% recycled cardboard (marked Ecopack) and the use of recyclable materials.



Alea, devenue une entreprise à mission, croit fermement dans une entreprise durable et porte son attention sur l'impact environnemental et à la santé des travailleurs. La poursuite de ces principes conduit notre entreprise à concentrer ses efforts sur le développement éco-compatible des processus de production et des produits finaux. En fait, l'une de nos priorités est la recherche constante de l'utilisation de matériaux recyclables.

Le conglomerat de bois utilisé pour la production des panneaux appartient à la classe CARB P2 pour les faibles émissions de formaldéhyde.

Les cloisons et les portes peuvent contribuer au barème de certification LEED® V4 NC New construction et LEED® V4 CI Commercial Interior pour les crédits suivants:

- Divulgation et optimisation des produits de construction, Approvisionnement des matières premières
- Gérance des déchets de construction et de démolition
- Réduction de l'impact du cycle de vie des intérieurs (LEED ID+C)
- Matériaux à faible émission
- Lumière du jour
- Performances acoustiques.

Alea a certifié son processus de qualité, conformément à la norme UNI EN ISO 9001 et a obtenu le certificat UNI EN ISO 14001 pour la gestion environnementale. Nous avons également certifié le système de gestion de la santé et de la sécurité conformément à la norme UNI ISO 45001.

Sur demande du client, Alea peut fournir des produits certifiés FSC® (code de licence FSC-C118323), selon la norme FSC-STD-40-004.

Toujours attentive aux initiatives environnementales, Alea garantit l'utilisation de 88% de carton recyclé (marque Ecopack) et l'utilisation de matériaux recyclables pour ses emballages.

Alea, ahora sociedad benefit, cree firmemente en el negocio sostenible y está muy centrada en el impacto medioambiental y en la salud de los trabajadores. La persecución de estos principios lleva nuestra empresa a centrar los esfuerzos en el desarrollo ecológico de los procesos de producción y de los productos finales. De hecho, una de nuestras prioridades es la investigación constante sobre el uso de materiales reciclables.

El conglomerado de madera que se utiliza para la producción de los paneles se clasifica en la clase P2 de CARB por sus bajas emisiones de formaldehído.

Las paredes divisorias y las puertas pueden contribuir a la puntuación de la certificación LEED® V4 NC New Construction y LEED® V4 CI Commercial Interior para los siguientes créditos:

- Divulgación y optimización de los productos de construcción, Adquisición de materias primas
- Gestión de residuos de construcción y demolición
- Reducción del impacto del ciclo de vida de los interiores (LEED ID+C)
- Materiales de baja emisión
- Luz diurna
- Rendimiento acústico.

Alea ha certificado su proceso de calidad según la norma UNI EN ISO 9001 y ha obtenido el certificado UNI EN ISO 14001 de gestión medioambiental. Además, hemos certificado nuestro sistema de gestión de la salud y la seguridad conforme a la norma UNI ISO 45001.

A petición del cliente, Alea puede suministrar productos certificados FSC® (código de licencia FSC-C118323) de acuerdo con la norma FSC-STD-40-004.

Siempre atenta a las iniciativas medioambientales, Alea garantiza para sus embalajes el uso de un 88% de cartón reciclado (marcado Ecopack) y la utilización de materiales reciclables.





direzionali

Executive
Mobilier de direction
Ejecutivos

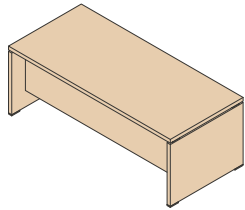

12
Odeon

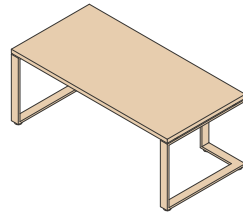

20
Archimede

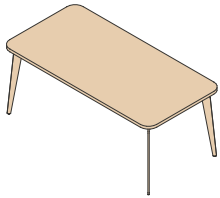

28
Blade X

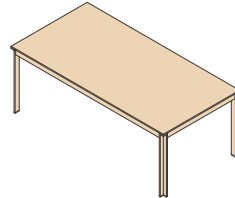

36
Zefiro X

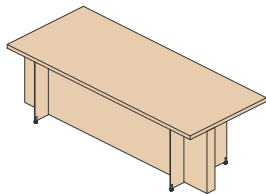

44
Oasi

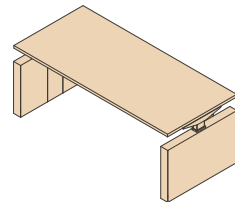

52
Crono X

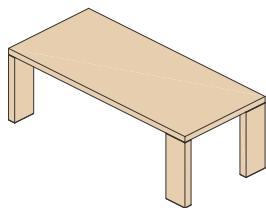

60
Titano

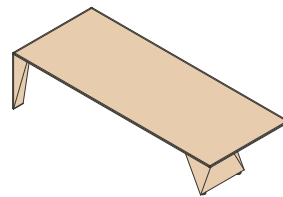

68
Eracle



Odeon

Odeon è una collezione direzionale capace di armonizzare soluzioni d'arredo classiche e moderne.

Propone infatti diverse tipologie di scrivanie e finiture, così da offrire un'ampia gamma di soluzioni estetiche e funzionali.

Oltre alla scrivania con gambe pannellate e con contenitore laterale strutturale, è disponibile anche quella con gambe angolari a sezione quadrata che, con l'applicazione di passacavi, possono essere utilizzate per il transito dell'elettrificazione.

I piani sono disponibili in legno (essenza o melaminico) in vetro retrolaccato (anche nella versione antimpronta), cuoio e gres, incorniciati da un profilo in alluminio.

Molto ampia l'offerta di tavoli riunione modulari.

Odeon is a versatile collection that has the ability of harmonizing classic and modern furniture solutions. It offers different types of desks in various materials.

Besides the classic version with panel legs and structural side storage units, Odeon is also offered with corner legs.

A grommet can be added to the square legs so that wires can be run through.

The tops are available in wood veneer or Italian melamine, in backlacquered glass (also in the antifinger version), leather and porcelain tile, framed by an aluminium profile.

Very wide is also the choice among modular meeting tables.

Odeon est une collection exécutive capable d'harmoniser des solutions d'ameublement classiques et modernes.

En effet, elle propose différents types de bureaux et de finitions, afin d'offrir une large gamme de solutions esthétiques et fonctionnelles.

En plus du bureau avec pieds panneaux et meuble de service structurel, il y a aussi un bureau à pieds carrés. Ces piétements peuvent être utilisés comme passe-câbles, pour le transit de l'électricité.

Les plateaux sont disponibles en bois ou mélaminé, en verre rétro-laqué (également dans la version anti tâches), en cuir et en grès, encadrés par un chant aluminium.

Il existe une large gamme de tables de réunion modulaires.

Odeon es una colección ejecutiva que se integra tanto en ambientes clásicos como modernos.

De hecho propone varios modelos de escritorios y acabados, ofreciendo así una amplia gama de soluciones estéticas y funcionales.

Además del escritorio con patas paneladas y contenedor lateral estructural, también está disponible el con patas de esquinas de sección cuadrada que, con la aplicación de un pasacables, pueden usarse para el tránsito de la electrificación.

Los tableros están disponibles en madera (chapada o melamina) en vidrio retrolacado (también en la versión antihuellas), cuero y gres porcelánico, enmarcados por un perfil de aluminio.

La oferta de mesas de reunión modulares es muy amplia.

Piano
Top
Plateau
Sobre



Struttura
Structure
Structure
Estructura



solid
classic
sharp



Odeon. collection



Uffici privati
Private offices
Bureaux privés
Oficinas privadas



Tavolini
Coffee tables
Tables basses
Mesitas



Sale riunioni
Meeting rooms
Salles de réunion
Salas de reuniones



Contentori
Cabinets
Rangements
Contenedores

1.



1. Scrivania | Desk | Bureau | Mesa **Fin.** RC
L 200 P 90 cm | W 78 3/4" D 35 3/8"

2. Tavolo | Table | Table | Mesa **Fin.** AK, CN
L 630 P 180 cm | W 248" D 70 7/8"

3. Scrivania | Desk | Bureau | Mesa **Fin.** GN, AK
L 200 P 90 cm | W 78 3/4" D 35 3/8"
Dattilo | Return | Retour | Ala
L 120 P 60 cm | W 47 1/4" D 23 5/8"

4. Scrivania | Desk | Bureau | Mesa **Fin.** NT, CN, EO
L 200 P 90 cm | W 78 3/4" D 47 1/4"
Mobile di servizio | Service unit | Meuble retour | Mueble de servicio
L 206 P 60 cm | W 81 1/8" D 25 5/8"







Piani | Desk tops | Plateaux | Sobres

Spessore 4 cm | 4 cm (1 5/8") thick | 4 cm d'épaisseur | 4 cm de espesor



Senza profilo - legno/melaminico

Without profile - wood veneer/Italian melamine
 Sans profil - bois/melaminé
 Sin perfil - madera/melamina



Con profilo - legno/melaminico/cuoio/vetro/gres

With profile - wood veneer/Italian melamine/leather/glass/
 porcelain tiles
 Avec profil - bois/melaminé/cuir/verre/grès cérame
 Con perfil - madera/melamina/cuero/vidrio/gres porcelánico

Gambe | Legs | Pieds | Patas



Gambe pannellate spessore 4 cm

Panel legs 4 cm (1 5/8") thick
 Piètements panneaux 4 cm d'épaisseur
 Patas paneladas 4 cm de espesor



Gambe angolari sezione 9x9 cm

Corner legs section 9x9 cm (3 1/2"x 3 1/2")
 Piètements d'angle section 9x9 cm
 Patas angulares sección 9x9 cm

Forme dei piani | Desk top shapes | Formes de plateaux | Formas de sobres

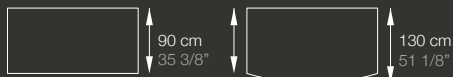

Scrivanie | Desks | Bureaux | Mesas

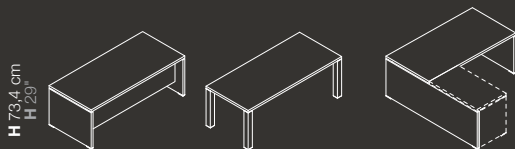

H 73.4 cm
H 29"

L 180/200 - P 90 cm
W 70 7/8"-78 3/4" - D 35 3/8"

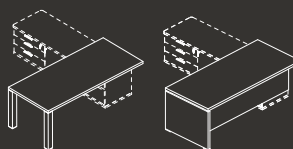

L 180/200 - P 90 cm
W 70 7/8"-78 3/4" - D 35 3/8"

Dattilo | Returns | Retours | Alas

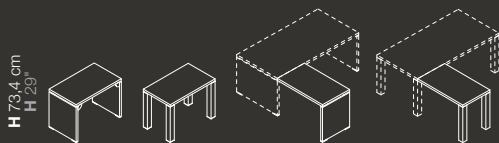

H 73.4 cm
H 29"

L 100/120 - P 60 cm
W 39 3/8"-47 1/4" - D 23 5/8"

Briefing | Briefing | Briefing | Briefing

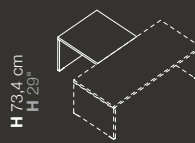

H 73.4 cm
H 29"

L 90/180 - P 80/90 cm
W 35 3/8"-70 7/8" - D 31 1/2"-35 3/8"

Tavoli riunione | Meeting tables | Tables de réunion | Mesas de juntas



H 73.4 cm
H 29"

L/P 80/90/100/120/130/150 cm
W/D 31 1/2"-35 3/8"-39 3/8"-47 1/4"-51 1/8"-59"

L 210/280 - P 120 cm
W 82 5/8"-110 1/4" - D 47 1/4"

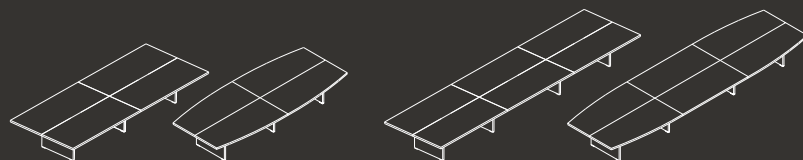

L 420 - P 180 cm
W 165 3/8" - D 70 7/8"

L 490/560/630 - P 180 cm
W 192 7/8"-220 1/2"-248" - D 70 7/8"

Mobili di servizio | Service units | Meuble retour | Muebles de servicio



H 56 cm
H 22"

L 138,5 - P 60 cm
W 54 1/2" - D 23 5/8"

L 177/207 - P 60 cm
W 69 3/4"-81 1/2" - D 23 5/8"



H 59 cm
H 23 1/4"

L 138,5 - P 60 cm
W 54 5/8" - D 23 5/8"

Tavolini da caffè | Coffee tables | Tables basses | Mesitas



H 40 cm
H 15 3/4"

L/P 60 cm
W/D 23 5/8"

L 120 - P 60 cm
W 47 1/4" - D 23 5/8"

Archimede

Archimede è una collezione direzionale dal design lineare e leggero. La struttura portante è costituita da gambe in metallo con finitura epossidica o in acciaio inox spazzolato lucido, che presentano tre opzioni di design: ad anello, a T e la distintiva sagoma ad L che permettono di sostenere il piano senza l'ausilio di travi strutturali.

I piani sono disponibili in legno (essenza o melaminico), in vetro retrolaccato (anche nella versione antimpronta), cuoio e gres, incorniciati da un profilo in alluminio. Archimede propone inoltre un contenitore laterale strutturale, con piedi abbinati alla scrivania e provvisto di ante scorrevoli, nel quale, è possibile includere una cassettera.

Archimede is an executive collection with a linear and lightweight design. The supporting structure consists of metal legs with an epoxy finish or polished brushed. Legs come in three possible design options: ring shape, T-shaped and L-shaped. All versions allow to support the top without the aid of structural beams.

Tops are available in wood veneer or Italian melamine, in backlacquered glass (also in the antifinger version), leather and porcelain tile, framed by an aluminium profile. Archimede also offers a side unit with sliding doors, with feet matching the desk, a small pedestal can be built into the unit.

Archimede est une collection directionnelle au design linéaire et léger. La structure portante est constituée de pieds en métal en finition époxy ou en acier inoxydable brossé poli, qui ont trois options de conception: l'anneau, la forme en T et la forme en L, qui permettent de supporter le plateau sans utiliser de poutres structurelles.

Les plateaux sont disponibles en bois ou mélaminé, en verre rétro-laqué (également dans la version anti-taches), en cuir et en grès cérame, encadrés par un profil aluminium. Archimede propose également un conteneur latéral structurel, avec des pieds assortis au bureau et équipé de portes coulissantes, dans lequel il est possible d'inclure un bloc tiroir.

Archimede es una colección ejecutiva con un diseño lineal y ligero. La estructura de soporte consiste en patas metálicas con acabado epoxi o en acero inoxidable pulido, que tienen tres opciones de diseño: en forma de anillo, la forma en T y la original forma en L, que permiten soportar el tablero sin el uso de vigas estructurales.

Los tableros están disponibles en madera (madera chapada o melamina) en vidrio lacado por detrás (también en la versión antihuellas), cuero y gres porcelánico, enmarcados por un perfil de aluminio. Archimede también ofrece un contenedor lateral estructural, con pies combinados con el escritorio y equipado con puertas correderas, en el cual es posible incluir una cajonera.

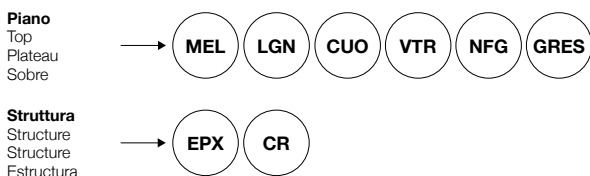

geometric
sleek
architectural





Archimede. collection



Tavolini
Coffee tables
Tables basses
Mesitas



Sale riunioni
Meeting rooms
Salles de réunion
Salas de reuniones



Librerie
Bookcases
Bibliothèques
Libreros

→ p. 224



Uffici privati
Private offices
Bureaux privés
Oficinas privadas



Contenitori
Cabinets
Rangements
Contenedores







1. Scrivania | Desk | Bureau | Mesa **Fin.** NO, EE, CN
L 240 P 120 cm | W 94 1/2" D 47 1/4"

2. Scrivania | Desk | Bureau | Mesa **Fin.** JN, EN
L 280 P 120 cm | W 110 1/4" D 47 1/4"
Mobile di servizio | Service unit | Meuble retour | Mueble de servicio
L 160 P 58 cm | W 63" D 22 7/8"

3. Scrivania | Desk | Bureau | Mesa **Fin.** MT, ET
L 240 P 90 cm | W 94 1/2" D 35 3/8"
Mobile di servizio | Service unit | Meuble retour | Mueble de servicio
L 200 P 60 cm | W 78 3/4" D 23 5/8"

4. Tavolo | Table | Table | Mesa **Fin.** GN, CR
L 280 P 120 cm | W 110 1/4" D 47 1/4"

5. Tavolo | Table | Table | Mesa **Fin.** NT
L 280 P 120 cm | W 110 1/4" D 47 1/4"

Piani | Desk tops | Plateaux | Sobres

Spessore 4 cm | 4 cm (1 5/8") thick | 4 cm d'épaisseur | 4 cm de espesor



Senza profilo - legno/melaminico

Without profile - wood veneer/Italian melamine
Sans profil - bois/mélangé
Sin perfil - madera/melamina

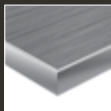

Con profilo - legno/melaminico/cuoio/vetro/gres

With profile - wood veneer/Italian melamine/leather/glass/porcelain tiles
Avec profil - bois/mélangé/cuir/verre/grès cérame
Con perfil - madera/melamina/cuero/vidrio/gres porcelánico

Gambe | Legs | Pieds | Patas

Sezione 8x2 cm | Section 8x2 cm (3 1/8"x3/4") thick | Section 8x2 cm | Sección 8x2 cm

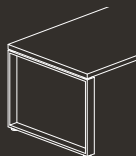

Gamba ad anello

Ring leg
Pied en anneau
Pata en anillo

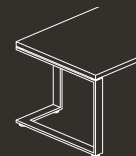

gamba a L

L leg
pied en L
pata en L



Gamba a T

T leg
Pied en T
Pata en T

Scrivanie | Desks | Bureaux | Mesas

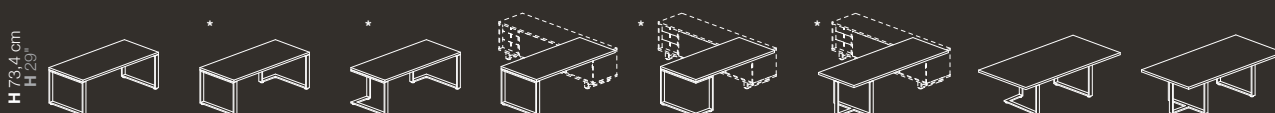

L 180/200/*220/*240 - P 90 cm
W 70 7/8"-78 3/4"-*86 5/8"-*94 1/2" - D 35 3/8"

L 240/280 - P 120 cm
W 94 1/2"-110 1/4" - D 47 1/4"

Dattilo | Returns | Retours | Alas

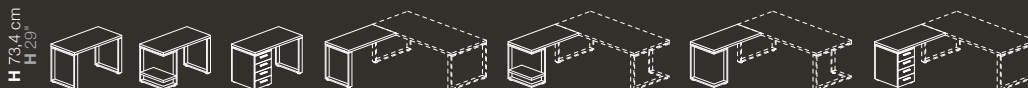

L 100/120 - P 60 cm
W 39 3/8"-47 1/4" - D 23 5/8"

Tavoli riunione | Meeting tables | Tables de réunion | Mesas de juntas



Ø 100/120/130/150 cm
Ø 39 3/8"-47 1/4"-51 1/8"-59"

L/P 120/130/150 cm
W/D 47 1/4"-51 1/8"-59"

L 210/240/280 - P 120 cm
W 82 5/8"-94 1/2"-110 1/4" - D 47 1/4"



L 440 - P 120/150 cm
W 173 1/4" - D 47 1/4"-59"

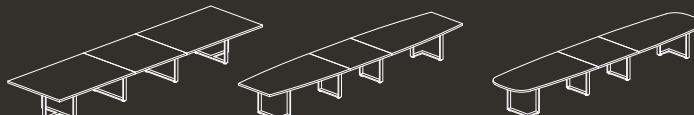

L 560 - P 120 cm/L 590 - P 150 cm
W 220 1/2" - D 47 1/4" - W 232 1/4" - D 59"

Mobili di servizio | Service units | Meuble retour | Muebles de servicio



L 160/180/200/240 - P 60/*90 cm
W 63"-70 7/8"-78 3/4"-94 1/2" - D 23 5/8"-*35 3/8"

***P 90 cm con vani a giorno esterni**

*D 90 cm (35 3/8") with external open compartments
*D 90 cm avec compartiments extérieurs ouverts
*D 90 cm con compartimentos abiertos externos

Tavolini da caffè | Coffee tables | Tables basses | Mesitas



L/P 60 cm
W/D 23 5/8"

L 120 - P 60 cm
W 47 1/4" - D 23 5/8"

Librerie | Bookshelves | Bibliothèque | Librerías

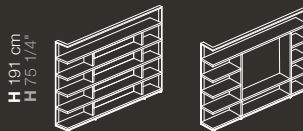

L 272 - P 36 cm
W 107 1/8" - D 14 1/8"

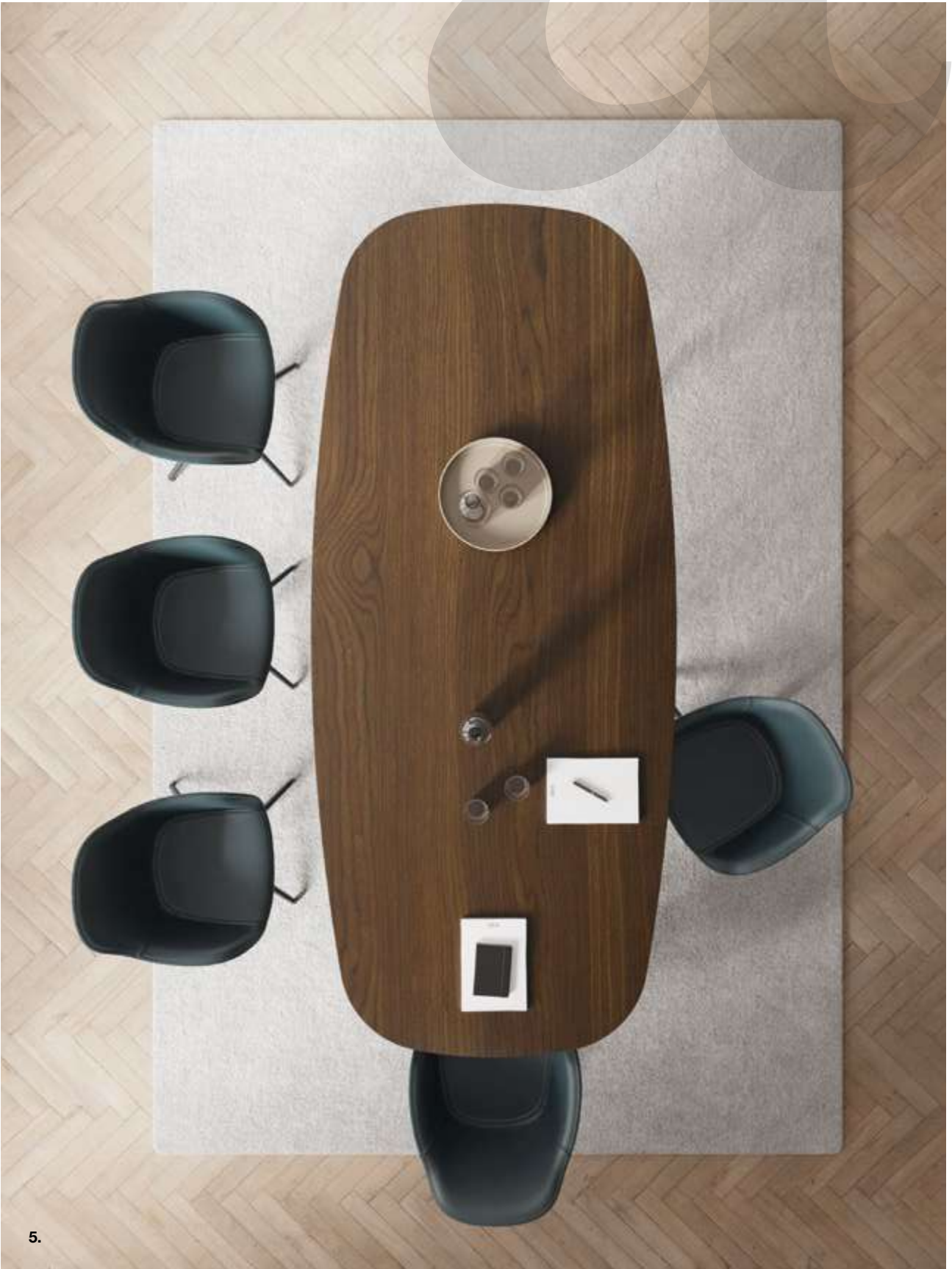

5.



Blade X

Blade X è una collezione direzionale moderna caratterizzata da un design raffinato e originale.

Il piano scrivania può avere bordature sia dritte che smussate, mentre la gamba in acciaio tagliata a laser può arricchirsi di rivestimenti in legno massello con essenza abbinata al piano scrivania oppure in cuoio e a un eventuale contenitore laterale strutturale.

La versione più prestigiosa della scrivania propone un piano trapezoidale di larghe dimensioni, con contenitore laterale e cassetto portapenne in massello.

Blade X is a modern managerial collection characterized by a refined and original design.

The desktop can have straight or chamfered edges, while the laser-cut steel leg can be enriched with leather or solid wood veneer covers matching the desktop and storage material and finish.

The most prestigious version of the desk, offers a large size trapezoidal top, with lateral storage unit and a solid wood pen tray.

Blade X est une collection directionnelle moderne reconnaissable grâce à son design raffiné et original.

Le plateau du bureau est disponible avec chant droit ou biseauté. Le pied en acier coupé au laser peut être enrichi d'un habillage en cuir ou en bois massif sur ses deux faces. Il peut être assorti à la finition du plateau ainsi que son meuble de service.

La version la plus prestigieuse du bureau dispose d'un grand plateau trapézoïdal, avec un conteneur latéral et un tiroir-plumier en bois massif.

Blade X es una colección direccional moderna, caracterizada por un diseño lineal y cautivador.

La pata de acero cortada con láser puede enriquecerse con cubiertas de cuero o de madera maciza con chapa que coincida con la parte superior del escritorio y la unidad de almacenamiento estructural.

La versión más prestigiosa del escritorio ofrece una tapa trapezoidal de gran tamaño con una unidad de almacenamiento lateral y un cajón portalápices en madera maciza.

Piano
Top
Plateau
Sobre



Struttura
Structure
Structure
Estructura



sophisticated
charismatic
contemporary



Blade X. collection



Uffici privati
Private offices
Bureaux privés
Oficinas privadas

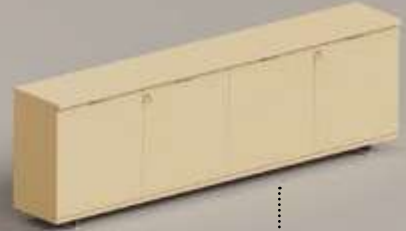

Credenze
Credenzas
Buffets
Credenzas

→ p. 254



Contenitori
Cabinets
Rangements
Contenedores



Sale riunioni
Meeting rooms
Salles de réunion
Salas de reuniones

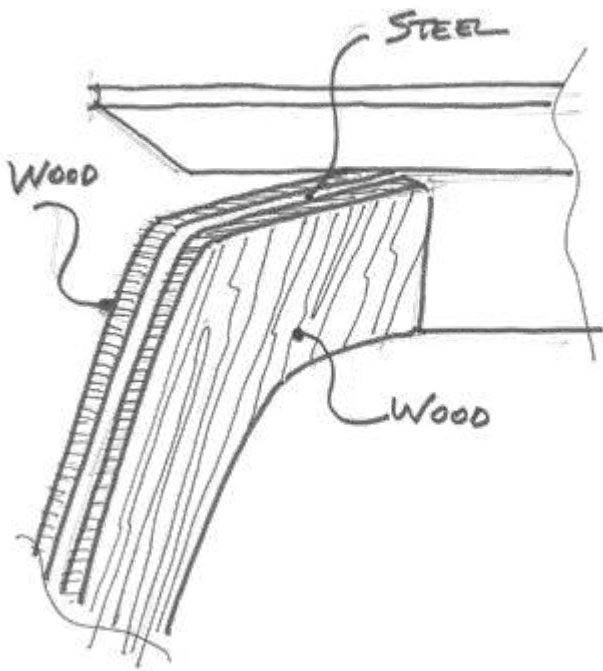





5.



1. Tavolo | Table | Table | Mesa **Fin.** RG, EB
 L 280 P 120 cm | **W** 110 1/4" **D** 47 1/4"

2. Tavolo | Table | Table | Mesa **Fin.** AK, EE
 L 420 P 120 cm | **W** 165 3/8" **D** 47 1/4"

3. Scrivania | Desk | Bureau | Mesa **Fin.** NO, EI
 L 220 P 90 cm | **W** 86 5/8" **D** 35 3/8"

4. Scrivania | Desk | Bureau | Mesa **Fin.** NT, EK, CM
 L 240 P 120 cm | **W** 94 1/2" **D** 47 1/4"

Mobile di servizio | Service unit | Meuble retour | Mueble de servicio
 L 208 P 62 cm | **W** 94 1/2" **D** 24 3/8"

5. Scrivania | Desk | Bureau | Mesa **Fin.** AK, EO
 L 200 P 90 cm | **W** 78 3/4" **D** 35 3/8"

Mobile di servizio | Service unit | Meuble retour | Mueble de servicio
 L 145 P 62 cm | **W** 57 1/8" **D** 24 3/8"

6. Scrivania | Desk | Bureau | Mesa **Fin.** ME, EZ
 L 220 P 90 cm | **W** 86 5/8" **D** 35 3/8"

Dattilo | Return | Retour | Ala
 L 100 P 60 cm | **W** 39 3/8" **D** 23 5/8"

7. Tavolo | Table | Table | Mesa **Fin.** CE, EZ
 L 120 P 120 cm | **W** 47 1/4" **D** 47 1/4"



6.



7.

Piani | Desk tops | Plateaux | Sobres

Spessore 3 cm | 3 cm (1 1/4") thick | 3 cm d'épaisseur | 3 cm de espesor



Melaminico
Italian melamine
Mélaminé
Melamina

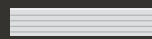

Legno
Wood veneer
Bois
Madera



Legno con bordi smussati
Wood veneer with chamfered edge
Bois avec bords biseautés
Madera con bordes biselados

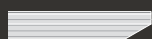

Legno e cuoio con bordi smussati
Wood veneer and leather with chamfered edge
Bois et cuir avec bords biseautés
Madera y cuero con bordes biselados

Gambe | Legs | Pieds | Patas

Spessore 1,2 cm | 1,2 cm (1/2") thick | 1,2 cm d'épaisseur | 1,2 cm de espesor

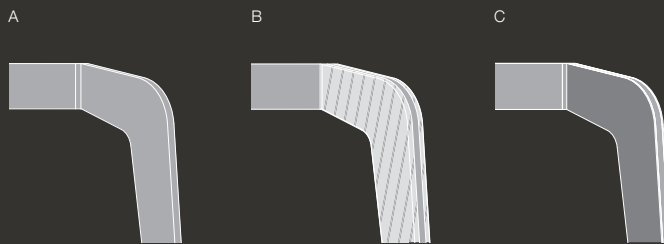

A) Metallo verniciato epossidico B) Con rivestimento in legno C) Con rivestimento in cuoio

A) Metal epoxy painted B) With wood veneer cover C) With leather cover
A) Métal peint époxy B) Avec revêtement en bois C) Avec revêtement en cuir
A) Metal pintado epoxi B) Con recubrimiento de madera C) Con recubrimiento de cuero

Scrivanie | Desks | Bureaux | Mesas

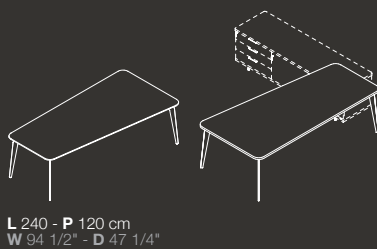

Dattilo | Returns | Retours | Alas

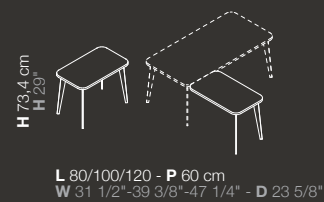

Tavoli riunione | Meeting tables | Tables de réunion | Mesas de juntas

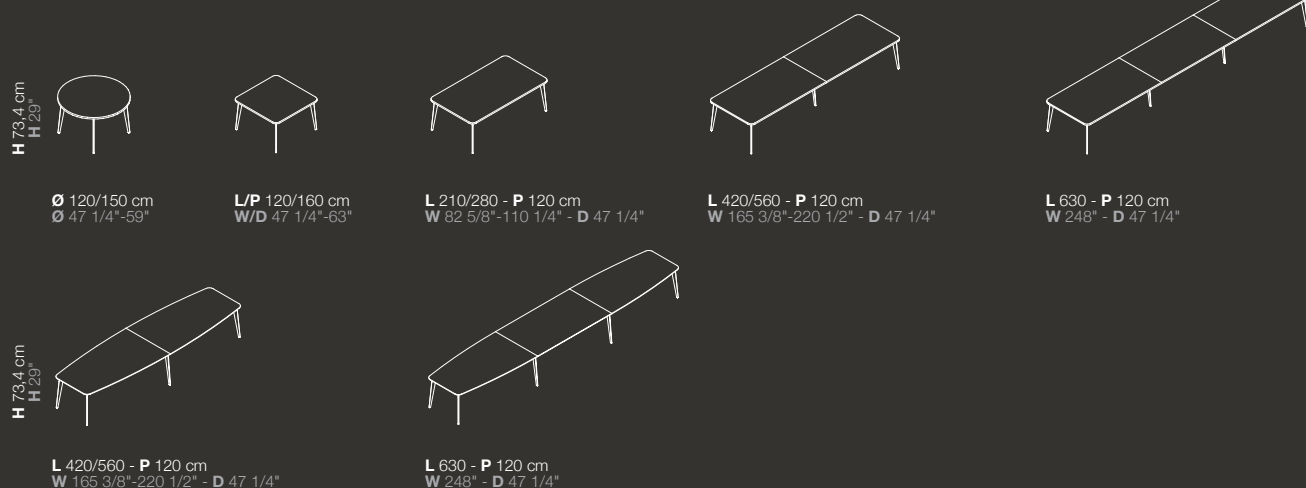

Mobili di servizio | Service units | Meuble retour | Muebles de servicio

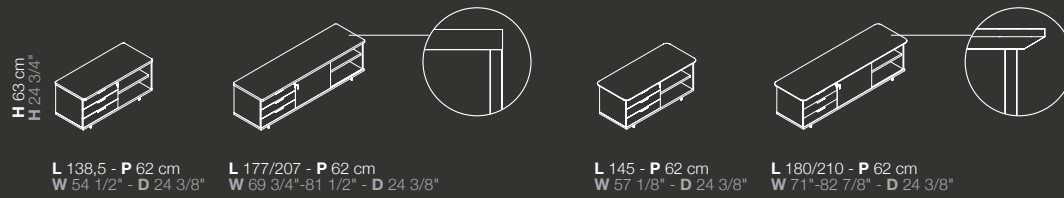

Credenze | Credenzas | Buffets | Credenzas

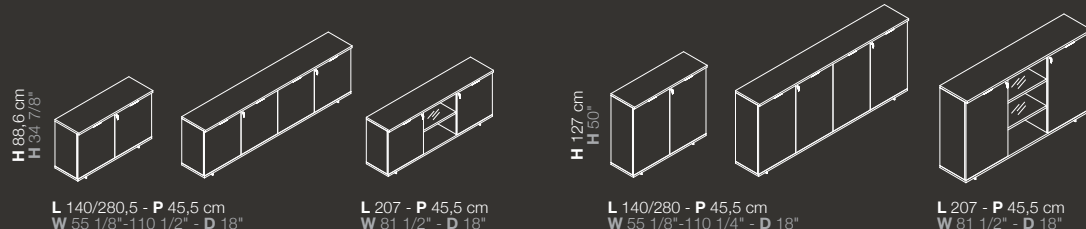

Zefiro X

Zefiro è una delle collezioni Alea più amate di sempre. Nel 2003, anno della sua nascita, è stato inserito nel volume ADI Design Index, che lo ha celebrato come uno dei prodotti più significativi di quel periodo.

Oggi riproponiamo quel design, con una rivisitazione in chiave moderna, introducendo nuovi materiali e finiture per una veste puramente direzionale. Nasce così Zefiro X, che si declina in scrivanie, scrittoi e tavoli riunione.

Il design di Zefiro X rimane in equilibrio tra la forma e la funzione. La sua struttura si presenta sia con gamba di sezione quadrata, forte e lineare, che di sezione a L, dove la tecnicità si fa più presente.

Zefiro is one of the Alea's most popular collections ever. In 2003, the year of its birth, it was included in the ADI Design Index volume, which celebrated it as one of the most significant products of that period.

Today we are re-proposing that design, with a modern twist, introducing new materials and finishes for a purely managerial look. This is how Zefiro X was born, in the form of desks, writing desks and meeting tables.

Zefiro X design maintains a balance between form and function. Its structure comes either with a strong and linear square section leg, or with an L section, where technicality becomes more present.

Zefiro est l'une des collections les plus populaires de tous les temps d'Alea. En 2003, l'année de sa naissance, il a été inclus dans le volume de ADI Design Index, qui l'a célébré comme l'un des produits les plus significatifs de cette période.

Aujourd'hui, nous repropsons ce design, avec une touche de modernité, en introduisant de nouveaux matériaux et de nouvelles finitions pour un look purement managérial. C'est ainsi qu'il est né Zefiro X, sous la forme de bureaux, de pupitres et de tables de réunion.

Le design du Zefiro X reste en équilibre entre forme et fonction. Sa structure se présente soit avec un pied à section carrée forte et linéaire, soit avec une section en L, où la technicité est plus présente.

Zefiro es una de las colecciones más populares de Alea de la historia. En 2003, el año de su nacimiento, se incluyó en el volumen ADI Design Index, que lo celebraba como uno de los productos más significativos de la época.

Hoy volvemos a proponer ese diseño, con un toque moderno, introduciendo nuevos materiales y acabados para un aspecto puramente empresarial. Así nació Zefiro X, en forma de mesas de trabajo, escritorios y mesas de reunión.

El diseño de Zefiro X mantiene el equilibrio entre forma y función. Su estructura se presenta con una pata de sección cuadrada, fuerte y lineal, o con una sección en L, donde la tecnicidad está más presente.

Piano
Top
Plateau
Sobre



Struttura
Structure
Structure
Estructura



linear
design
smart





Zefiro X. collection



Uffici privati
Private offices
Bureaux privés
Oficinas privadas



Sale riunioni
Meeting rooms
Salles de réunion
Salas de reuniones



Piani | Desk tops | Plateaux | Sobres

Spessore 1,2 cm | 1,2 cm (1/2") thick | 1,2 cm d'épaisseur | 1,2 cm de espesor

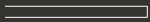

Melaminico/Legno/Fenix
Melamine/Wood veneer/Fenix
Mélaminé/Bois/Fenix
Melamina/Madera/Fenix

Gambe | Legs | Pieds | Patas

Sezione 5,4x5,4 cm | Section 5,4x5,4 cm (2 1/8"x2 1/8") thick | Section 5,4x5,4 cm | Sección 5,4x5,4 cm

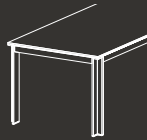

Sezione a L in alluminio
L section, aluminium
Section L, en aluminium
Sección en L, en aluminio

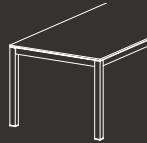

Sezione quadrata in alluminio
Square section, aluminium
Section carrée, en aluminium
Sección cuadrada, en aluminio

Scrivanie | Desks | Bureaux | Mesas

Dattilo | Returns | Retours | Alas

H 73,4 cm
H 29"

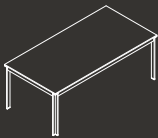

L 180/200 - P 90 cm
W 70 7/8"-78 3/4" - D 35 3/8"

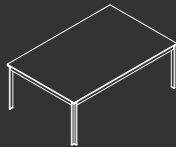

L 200/240/280 - P 120 cm
W 78 3/4"-94 1/2"-110 1/4" - D 47 1/4"

H 73,4 cm
H 29"



L 120/140/160/180 - P 60 cm
W 47 1/4"-55 1/8"-63"-70 7/8" - D 23 5/8"

Tavoli riunione | Meeting tables | Tables de réunion | Mesas de juntas

H 73,4 cm
H 29"



L/P 90/120 cm
W/D 35 3/8"-47 1/4"

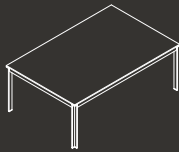

L 200/240/280 - P 120 cm
W 78 3/4"-94 1/2"-110 1/4" - D 47 1/4"

H 73,4 cm
H 29"



L/P 150 cm
W/D 59"

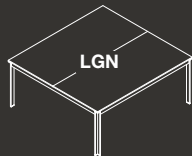

L 200/240/280 - P 120 cm
W 78 3/4"-94 1/2"-110 1/4" - D 47 1/4"

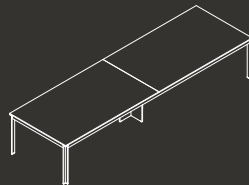

L 400 - P 120 cm
W 157 1/2" - D 47 1/4"

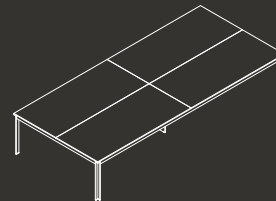

L 400 - P 180 cm
W 157 1/2" - D 70 7/8"

Basamenti per tavoli multipli L 400 cm | Support for multiple tables W 400 cm (157 1/2") | Bases pour tables multiples L 400 cm | Bases para mesas múltiples L 400 cm



Basamento ispezionabile in metallo verniciato epossidico
Inspectable epoxy painted metal basement
Base inspectable métallique peinte à l'époxy
Base inspeccionable metálica pintada con epoxi



Basamento a croce in metacrilato trasparente
Cross transparent acrylic base
Piètement en forme de croix en méthacrylate transparent
Base en forma de cruz en metacrilato transparente



4.





1. Scrivania | Desk | Bureau | Mesa **Fin.** XE, EB
L 280 P 120 cm | W 110 1/4" D 47 1/4"

2. Tavolo | Table | Table | Mesa **Fin.** XC, YC
L 400 P 120 cm | W 157 1/2" D 47 1/4"

3. Tavolo | Table | Table | Mesa **Fin.** NT, EN
L/P 150 cm | W/D 59"

4. Scrivania | Desk | Bureau | Mesa **Fin.** XB, YB
L 280 P 120 cm | W 110 1/4" D 47 1/4"

5. Tavolo | Table | Table | Mesa **Fin.** XA, EN
L 400 P 120 cm | W 157 1/2" D 47 1/4"



Oasi

Il design di Oasi è raffinato e contemporaneo e combina comfort e funzionalità.

La sua peculiarità consiste nella coppia di lame in metallo che sostiene il piano scrivania, caratterizzato dalla possibilità di abbinare due materiali insieme a un profilo perimetrale in alluminio.

Tutto è a portata di mano e le soluzioni per contenimento ed elettrificazione sono discrete ed eleganti.

Oasi's design is sophisticated and modern, providing comfort and functionality at the same time.

Oasi's distinctiveness is a pair of metal blades that support the desk top. The latter features the possibility of combining two materials with an aluminium frame.

Everything is at your fingertips and the solutions for storage and wire management are discreet and elegant.

Le design de Oasi est raffiné et contemporain, il allie confort et fonctionnalité.

La particularité de Oasi consiste en une paire de lames métalliques qui supporte le bureau. Ce dernier se caractérise par la possibilité de combiner deux matériaux avec le chant périmétrique en aluminium.

Tout est à portée de main et les solutions de rangement et d'électrification sont discrètes et élégantes.

El diseño de Oasi es refinado y contemporáneo y combina confort y funcionalidad.

La peculiaridad de Oasi consiste en el par de hojas de metal que soportan el sobre de la mesa. Este último se caracteriza por la posibilidad de combinar dos materiales junto con un perfil perimetral de aluminio.

Todo está a la mano y las soluciones para contención y la electrificación son discretas y elegantes.

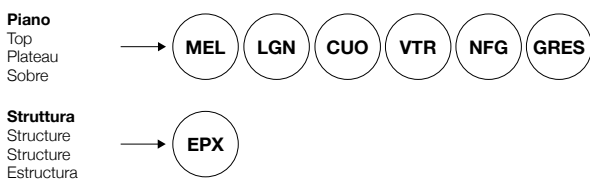

contrast
crisp
high-end



Oasi. collection



Sale riunioni
Meeting rooms
Salles de réunion
Salas de reuniones



Credenze
Credenzas
Buffets
Credenzas

p. 258 ←



Contentori
Cabinets
Rangements
Contenedores



Uffici privati
Private offices
Bureaux privés
Oficinas privadas

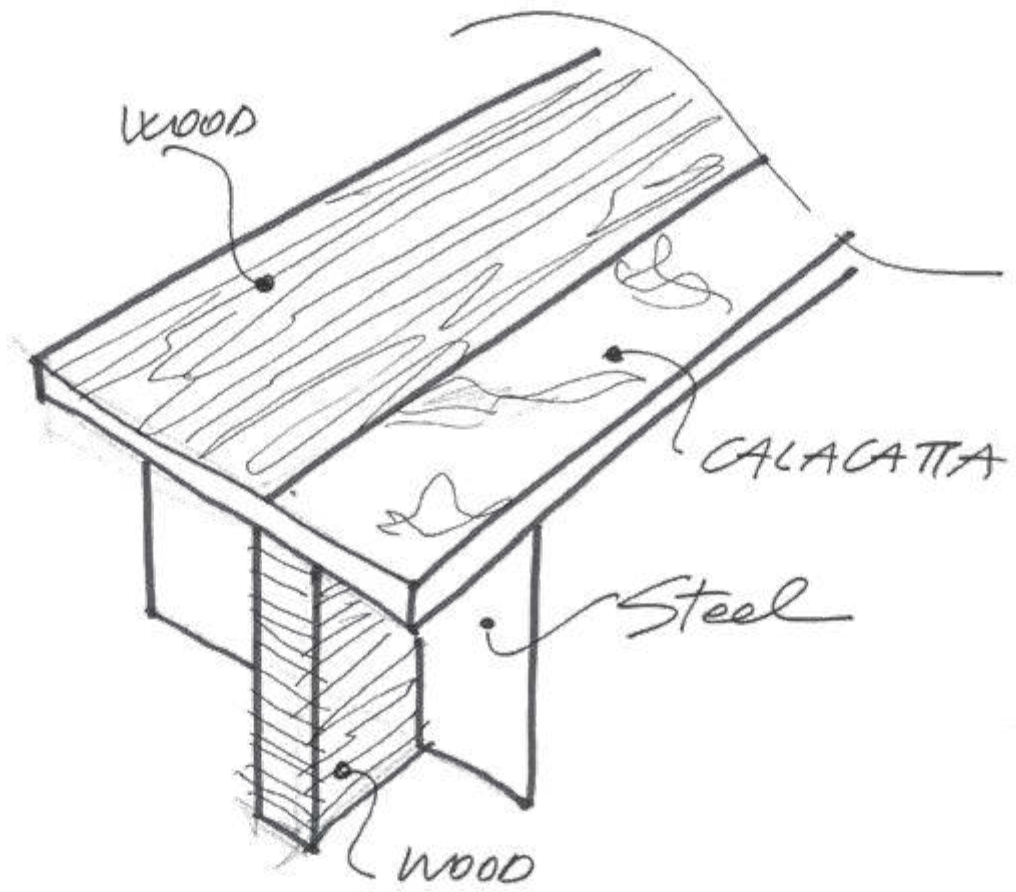



2.

1. Scrivania | Desk | Bureau | Mesa **Fin.** AK, JC, EI
L 200 P 100 cm | W 78 3/4" D 39 3/8"

2. Tavolo | Table | Table | Mesa **Fin.** AK, CN, EN
L 630 P 180 cm | W 248" D 70 7/8"

3. Tavolo | Table | Table | Mesa **Fin.** RC, EK
L 280 P 120 cm | W 110 1/4" D 47 1/4"

4. Scrivania | Desk | Bureau | Mesa **Fin.** AK, CN, EZ
L 240 P 120 cm | W 94 1/2" D 47 1/4"

Mobile di servizio | Service unit | Meuble retour | Mueble de servicio L 207 P 60 cm | W 81 1/2" D 23 5/8"

5. Scrivania | Desk | Bureau | Mesa **Fin.** NO, CN, EZ
L 240 P 120 cm | W 94 1/2" D 47 1/4"

Mobile di servizio | Service unit | Meuble retour | Mueble de servicio L 207 P 60 cm | W 81 1/2" D 23 5/8"



Piani | Desk tops | Plateaux | Sobres

Spessore 4 cm | 4 cm (1 5/8") thick | 4 cm d'épaisseur | 4 cm de espesor



Senza profilo - legno/melaminico
Without profile - wood veneer/Italian melamine
Sans profil - bois/mélaminé
Sin perfil - madera/melamina

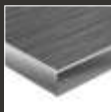

Con profilo - legno/melaminico/cuoio/vetro/gres
With profile - wood veneer/Italian melamine/leather/glass/porcelain tiles
Avec profil - bois/mélaminé/cuir/verre/grès cérame
Con perfil - madera/melamina/cuero/vidrio/gres porcelánico

Struttura | Structure | Structure | Estructura

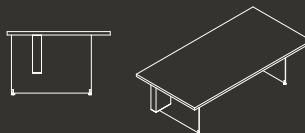

Modesty rialzato di 250 mm
250 mm (9 7/8") raised modesty panel
Voile de fond relevé de 250 mm
Faldón elevado de 250 mm

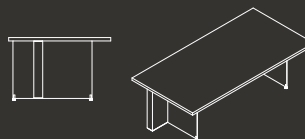

Modesty a tutta altezza
Full-height modesty panel
Voile de fond toute hauteur
Faldón altura total

Scrivanie | Desks | Bureaux | Mesas

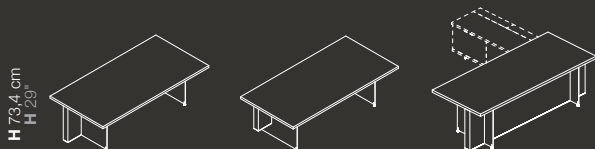

H 73,4 cm
H 29"

L 200/220/240 - P 100 cm/L 240 - P 120 cm
W 78 3/4"-86 5/8"-94 1/2" - D 39 3/8"- W 94 1/2" - D 47 1/4"

Dattilo/briefing | Return/briefing | Retour/briefing | Ala/briefing

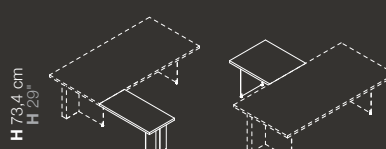

H 73,4 cm
H 29"

L 120 - P 60 cm
W 47 1/4" - D 23 5/8" L 90 - P 80 cm/L 180 - P 90 cm
W 35 3/8" - D 31 1/2" - W 70 7/8" - D 35 3/8"

Tavoli riunione | Meeting tables | Tables de réunion | Mesas de juntas

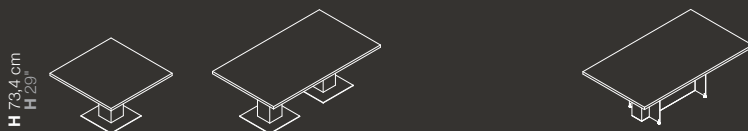

H 73,4 cm
H 29"

L/P 120 cm L 210/280 P 120 cm L 210/280 - P 120 cm
W/D 47 1/4" W 82 5/8"-110 1/4" - D 47 1/4" W 82 5/8"-110 1/4" - D 47 1/4"

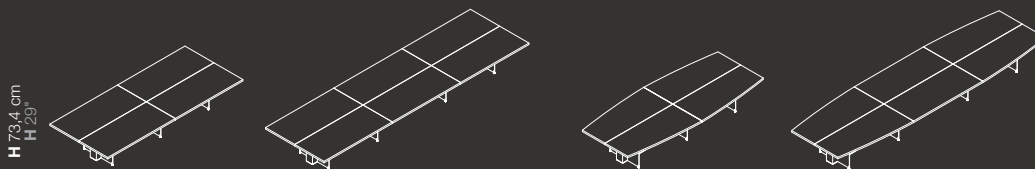

H 73,4 cm
H 29"

L 420 - P 180 cm L 490/560/630 - P 180 cm L 420 - P 180 cm L 490/560/630 - P 180 cm
W 165 3/8" - D 70 7/8" W 192 7/8"-220 1/2"-248" - D 70 7/8" W 165 3/8" - D 70 7/8" W 192 7/8"-220 1/2"-248" - D 70 7/8"

Mobili di servizio | Service units | Meuble retour | Muebles de servicio

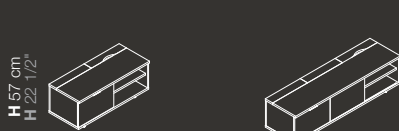

H 57 cm
H 22 1/2"

L 138 - P 60 cm L 207 - P 60 cm
W 54 3/8" - D 23 5/8" W 81 1/2" - D 23 5/8"

Credenze | Credenzas | Buffets | Credenzas



H 86 cm
H 33 7/8"

H 90 cm
H 35 3/8"

L 242 - P 45,5 cm L 254 - P 47,5 cm
W 95 1/4" - D 17 7/8" W 100" - D 18 3/4"



4.



5.

Crono X

Crono è un sistema di scrivanie regolabili elettricamente in altezza.

Il sistema è stato studiato e progettato per rispondere alla necessità di creare postazioni di lavoro ergonomiche, capaci di maggiore attenzione alla salute e al benessere dell'utilizzatore.

La collezione Crono prevede delle composizioni che soddisfano le esigenze direzionali proponendo gambe integrate a muretti, che possono abbinarsi anche a contenitori laterali strutturali.

Crono is an electrical height-adjustable system fitting freestanding desks.

The system has been designed to respond to the demand of ergonomic workstations oriented to the health and well-being of the user.

Crono collection includes compositions that meet executive needs by offering legs solid legs, which can also be combined with structural side storage.

Crono est un système de bureaux réglables en hauteur avec commande électronique.

Le système a été étudié et conçu pour répondre à la nécessité de créer des postes de travail ergonomiques et de prêter plus d'attention à la santé et au bien-être de l'utilisateur.

La collection Crono prévoit des compositions qui satisfont également les exigences directionnelles en proposant pieds intégrés aux "parois". Cette "paroi" a la possibilité de s'assortir à la finition du meuble retour structurel.

Crono es un sistema de mesas y estaciones de trabajo regulables eléctricamente en altura.

El sistema ha sido estudiado y diseñado para responder a la necesidad de crear puestos de trabajo ergonómicos orientados a la salud y el bienestar del usuario.

La colección Crono también puede utilizarse para despachos de dirección gracias a las patas "costados", que también pueden combinarse con armarios laterales estructurales.

Piano
Top
Plateau
Sobre



Struttura
Structure
Structure
Estructura



functional
ergonomic
strong





Crono X. collection



Contenitori
Cabinets
Rangements
Contenedores



Uffici privati
Private offices
Bureaux privés
Oficinas privadas

1. Scrivania | Desk | Bureau | Mesa **Fin.** NT, EI
L 200 P 90 cm | W 78 3/4" D 35 3/8"
Mobile di servizio | Service unit | Meuble retour | Mueble de servicio
L 200 P 580 cm | W 78 3/4" D 22 7/8"

2. Scrivania | Desk | Bureau | Mesa **Fin.** RG, EI
L 200 P 90 cm | W 78 3/4" D 35 3/8"

3. Scrivania | Desk | Bureau | Mesa **Fin.** NT, EI
L 200 P 90 cm | W 78 3/4" D 35 3/8"
Mobile di servizio | Service unit | Meuble retour | Mueble de servicio
L 200 P 580 cm | W 78 3/4" D 22 7/8"







Piani e strutture | Desk tops and structures | Plateaux et structures | Sobres y estructuras

Spessore 3 cm - melaminico/legno
 3 cm (1 1/4") thick - Italian melamine/wood veneer
 3 cm d'épaisseur - mélaminé/bois
 3 cm de espesor - melamina/madera

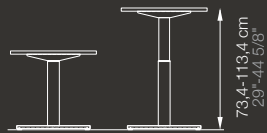

1 step
 1 step
 1 niveau
 1 step

Pulsantiera | Handswitch | Tableau | Mando de control

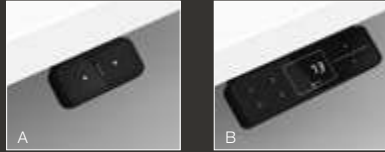

A) Pulsantiera semplice, B) pulsantiera con 4 memorie
 A) Basic handswitch, B) handswitch with 4 memories
 A) Tableau simple, B) tableau avec 4 mémoires
 A) Mando de control simple, B) mando de control con 4 memorias

Piede scrivania freestanding | Freestanding desk foot | Pied pour bureau individuel | Pie para mesa individual

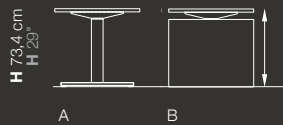

A) Dritto simmetrico, B) Muretto
 A) Straight symmetrical, B) Solid leg
 A) Droit symétrique, B) Cloison
 A) Recto simétrico, B) Costado

Scrivanie | Desks | Bureaux | Mesas



L 180/200 - P 80/90 cm
W 70 7/8"-78 3/4" - D 31 1/2"-35 3/8"

L 180/200 - P 80/90 cm
W 70 7/8"-78 3/4" - D 31 1/2"-35 3/8"

Mobili di servizio | Service units | Meuble retour | Muebles de servicio



L 142/180/190 - P 58 cm
W 55 3/4"-70 7/8"-74 3/4" - D 22 7/8"





Titano

Titano è una collezione direzionale di alta gamma che si contraddistingue per un design dai segni forti e rigorosi, accentuati anche dallo spessore di 60 mm di piani e gambe. L'eleganza del disegno si tramuta nell'attenta cura del dettaglio, nell'uso di materiali di grande qualità (legno e cuoio) e nella sapiente maestria artigianale.

La collezione Titano si articola in varie tipologie di tavoli, tra le quali spiccano le scrivanie freestanding con gambe a sezione rettangolare che si possono assemblare a "schema libero" in quanto, al momento dell'aggregazione al piano, è possibile decidere la loro posizione, secondo molteplici possibilità compositive che creano originali geometrie.

Titano offre inoltre la possibilità di aggregare alla scrivania, un contenitore laterale strutturale dotato di anta scorrevole e cassettera integrata.

Piano
Top
Plateau
Sobre



Struttura
Structure
Structure
Estructura



thick
modern
robust

Titano is a high-end collection that stands out for its strong and rigorous design features, emphasized also by its 60 mm (2 3/8") thick tops and legs. The elegance of the design is a result of attention to details, use of high quality materials (wood and leather) and excellent craftsmanship.

The Titano collection is divided into various styles of tables, among which stands out the freestanding desk with rectangular section legs; the latter can have multiple positions and orientations and their location below the desk can be chosen on site.

Titano also offers a structural side unit with sliding doors with a built in pedestal option.

Very wide is also the choice among modular meeting tables.

Titano est une collection directionnelle haut de gamme qui se distingue par son design fort et rigoureux, accentué par les plateaux et les pieds de 60 mm d'épaisseur. L'élégance du design se traduit par une attention particulière aux détails, par l'utilisation de matériaux de haute qualité (bois et cuir) et par l'habileté de l'exécution.

La collection Titano est divisée en différents types de tables, parmi lesquelles se détachent les bureaux autoportants à pieds rectangulaires qui peuvent être assemblés selon un "schéma libre" car, au moment du montage, il est possible de changer la configuration en utilisant les perçages prévus sur le plateau.

Titano offre également la possibilité d'ajouter un caisson latéral structural avec porte coulissante et caissons intégrés.

Titano es una colección de alta gama que se caracteriza por un diseño con signos fuertes y rigurosos, acentuados también por el grosor de 60 mm de tableros y patas. La elegancia del diseño se convierte en una cuidadosa atención al detalle, en el uso de materiales de alta calidad (madera y cuero) y una artesanía experta.

La colección Titano se articula en varios modelos de mesas, entre las cuales resaltan escritorios independientes con patas de sección rectangular. En el momento de la agregación con el tablero, es posible decidir la posición de las patas según múltiples posibilidades positivas que crean geometrías originales.

Titano también ofrece la posibilidad de agregar al escritorio, un contenedor lateral estructural con puerta corredera y cajonera integrada.



Titano. collection



Librerie
Bookcases
Bibliothèques
Libreros

→ p. 220



Uffici privati
Private offices
Bureaux privés
Oficinas privadas



Tavolini
Coffee tables
Tables basses
Mesitas



Salae riunioni
Meeting rooms
Salles de réunion
Salas de reuniones



Contenitori
Cabinets
Rangements
Contenedores



1.







4.

1. Tavolo | Table | Table | Mesa **Fin. AK**
 L 630 P 180 cm | W 248" D 70 7/8"

2. Scrivania | Desk | Bureau | Mesa **Fin. AK, MT**
 L 220 P 100 cm | W 86 5/8" D 39 3/8"

Mobile di servizio | Service unit | Meuble retour | Mueble de servicio
 L 178 P 63 cm | W 70 1/8" D 24 3/4"

3. Tavolino da caffè | Coffee table | Table basse | Mesita **Fin. AK**
 L/P 60 cm | W/D 23 5/8"

4. Scrivania | Desk | Bureau | Mesa **Fin. RC**
 L 200 P 100 cm | W 78 3/4" D 39 3/8"

Piano | Desk top | Plateau | Sobre

Spessore 6 cm | 6 cm (2 3/8") thick | 6 cm d'épaisseur | 6 cm de espesor

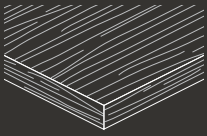

Legno
Wood veneer
Bois
Madera

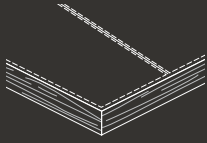

Legno con applicazione cuoio, cuciture a vista
Wood veneer with leather application, visible stitching
Bois avec application de cuir, coutures visibles
Madera con aplicación de cuero, costuras a la vista

Gambe | Legs | Pieds | Patas

Spessore 7,7 cm | 7,7 cm (3") thick | 7,7 cm d'épaisseur | 7,7 cm de espesor

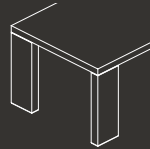

Gambe angolari
Corner legs
Piètements d'angle
Patas angulares

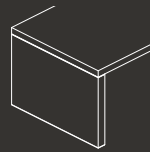

Gambe pannellate
Panel legs
Piètements panneaux
Patas paneladas

Scrivanie | Desks | Bureaux | Mesas

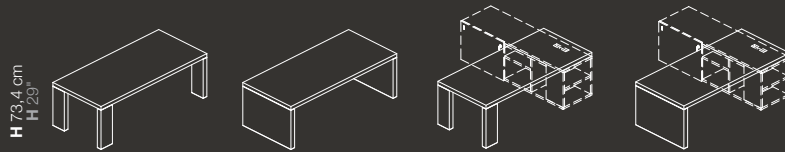

H 73,4 cm
H 29"

L 200/220 - P 100 cm
W 78 3/4" - 86 5/8" - D 39 3/8"

Dattilo | Returns | Retours | Alas

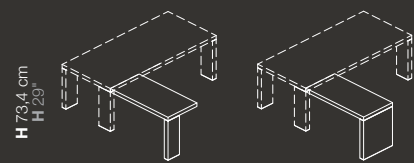

H 73,4 cm
H 29"

L 100/110/120 - P 60 cm
W 39 3/8" - 43 1/4" - 47 1/4" - D 23 5/8"

Tavoli riunione | Meeting tables | Tables de réunion | Mesas de juntas

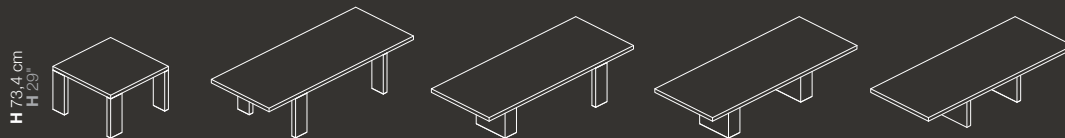

H 73,4 cm
H 29"

L/P 120 cm
W/D 47 1/4"

L 240/300 - P 120 cm
W 94 1/2" - 118 1/8" - D 47 1/4"

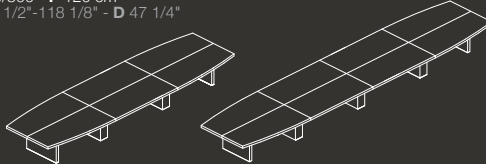
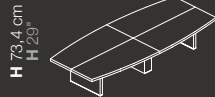

H 73,4 cm
H 29"

L 420 - P 180 cm
W 165 3/8" - D 70 7/8"

L 630 - P 180 cm
W 248" - D 70 7/8"

L 840 - P 180 cm
W 330 3/4" - D 70 7/8"



H 73,4 cm
H 29"

L/P 80/90/100/120 cm
W/D 31 1/2" - 35 3/8" - 39 3/8" - 47 1/4"

L 240/300 - P 120 cm
W 94 1/2" - 118 1/8" - D 47 1/4"

Tavolini da caffè | Coffee tables | Tables basses | Mesitas

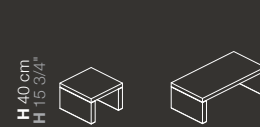

H 40 cm
H 15 3/4"

L/P 60 cm
W/D 23 5/8"

L 120 - P 60 cm
W 47 1/4" - D 23 5/8"

Mobili di servizio | Service units | Meuble retour | Muebles de servicio



H 66,5 cm
H 26 1/8"

L 178 - P 63 cm
W 70 1/8" - D 24 3/4"

L 210 - P 63 cm
W 82 5/8" - D 24 3/4"

Console | Console | Console | Console



H 82,5 cm
H 32 1/2"

L 180 - P 60 cm
W 70 7/8" - D 23 5/8"

Moduli | Modules | Modules | Módulos



H 38 cm
H 15"

L 38/79 - P 39,4 cm
W 15" - 31 1/8" - D 15 1/2"

Dimensioni vano utile
Internal dimensions
Dimensions utiles du module
Dimensiones útiles del módulo

Esempi librerie | Example bookshelves | Exemples bibliothèque | Ejemplos libreros

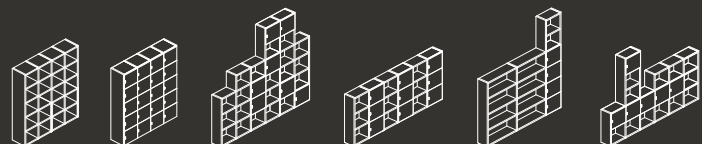

Eracle

Resistenza, armonia ed equilibrio sono le qualità riconosciute a ciò che è destinato a durare nel tempo.

Per questo motivo il design di Eracle è diventato un classico.

I suoi tavoli e scrivanie si distinguono infatti per le forme ricercate e lo studio di materiali innovativi.

Le gambe in alluminio sono il segno di riconoscimento di questa collezione, grazie alla loro particolare sfaccettatura a “diamante” che innalza il livello di ricercatezza.

Per i piani, si può invece scegliere tra numerosi materiali, dal melaminico al legno, dal cuoio al vetro, e ancora il gres porcellanato, sempre incorniciati da un telaio in alluminio.

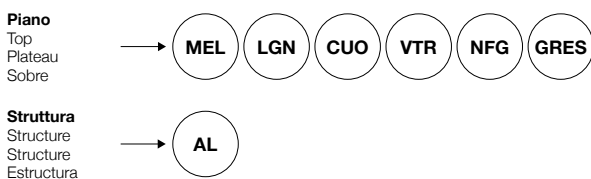

Resistance, harmony and balance are the acknowledged qualities of things made to last. This is why Eracle has become a classic. In fact, its tables and desks are recognizable for their sophisticated shapes and innovative materials research.

The aluminium legs are its signature, thanks to their particular “diamond facet” that enhances Eracle elegance level.

For the table top, there are several materials to choose from. Italian melamine, leather, wood veneer, glass or porcelain tiles always framed by an aluminium profile.

Résistance, harmonie et équilibre sont les qualités reconnues aux choses destinées à durer dans le temps.

C’est pour ce motif que le design d’Eracle est devenu un classique.

Ses tables et bureaux se distinguent par leurs formes raffinées et l’étude de matériaux innovants. Les pieds en aluminium sont la marque de fabrique de cette collection, grâce à leur facette particulière en “diamant” qui élève le niveau de sophistication.

Pour les plateaux, vous pouvez choisir parmi une large gamme de matériaux, à partir du mélaminé au bois, du cuir au verre, du grès cérame, toujours encadrés par un chant en aluminium.

La resistencia, la armonía y el equilibrio son las calidades que se reconocen a las cosas destinadas a durar en el tiempo.

Por esta razón, el diseño de Eracle se ha convertido en un clásico.

De hecho, sus mesas y escritorios se distinguen por sus formas refinadas y el estudio de materiales innovadores.

Las patas de aluminio son el signo de reconocimiento de esta colección, gracias a su particular faceta “diamante” que eleva el nivel de refinamiento.

Para los tableros, es posible elegir entre numerosos materiales, desde melamina hasta madera, desde cuero hasta vidrio e incluso gres porcelánico, siempre enmarcados por un marco de aluminio.

sculptural
refined
distinctive





Eracle. collection



Sale riunioni
Meeting rooms
Salles de réunion
Salas de reuniones



Uffici privati
Private offices
Bureaux privés
Oficinas privadas



Tavolini
Coffee tables
Tables basses
Mesitas



1.



2.



1. Scrivania | Desk | Bureau | Mesa **Fin.** AK, AL
L 240 **P** 120 cm | **W** 94 1/2" **D** 47 1/4"

2. Tavolo | Table | Table | Mesa **Fin.** JN, AL
L 300 **P** 120 cm | **W** 118 1/8" **D** 47 1/4"

3. Composizione | Composition | Composition | Composición
Fin. NT, AL **L** 600 **P** 120 cm | **W** 236 1/4" **D** 47 1/4"

4. Scrivania | Desk | Bureau | Mesa **Fin.** NT, AL
L 200 **P** 100 cm | **W** 78 3/4" **D** 39 3/8"
Tavolo | Table | Table | Mesa **Fin.** NT, AL
P/L 200 cm | **W** 78 3/4"

Piano | Desk top | Plateau | Sobre

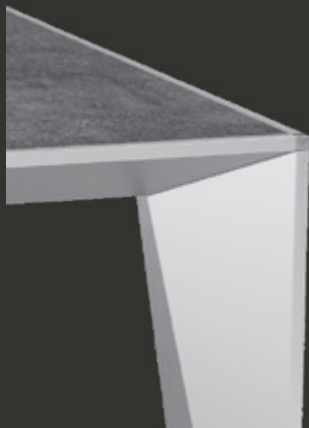

**Piani in legno/melaminico/
cuoio/vetro/gres**
Desk tops - wood veneer
Italian melamine/leather/glass/
porcelain tiles
Plateaux en bois/méla­miné/
cuir/verre/grès cérame
Sobre de madera/melamina/
cuero/ví­drio/gres porcelánico

Gambe | Legs | Pieds | Patas



Gambe angolari - alluminio/cuoio
Corner legs - aluminium/leather
Piètements d'angle - aluminium/cuir
Patas angulares - aluminio/cuero



Basamento a diamante - alluminio
Diamond-shaped base - aluminium
Base à diamant - aluminium
Base en forma de diamante - aluminio

Scrivanie | Desks | Bureaux | Mesas



H 73,4 cm
H 29"

L 200/240 - P 100/120 cm
W 78 3/4"-94 1/2" - D 39 3/8"-47 1/4"



L 240 - P 120 cm
W 94 1/2" - D 47 1/4"

Dattilo | Returns | Retours | Alas

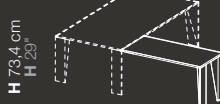

H 73,4 cm
H 29"

L 100/120 - P 60/80 cm
W 39 3/8"-47 1/4" - D 23 5/8"-31 1/2"

Tavoli riunione | Meeting tables | Tables de réunion | Mesas de juntas



H 73,4 cm
H 29"

L/P 120/150/200 cm
W/D 47 1/4"-59"-78 3/4"

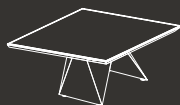

L/P 150 cm
W/D 59"

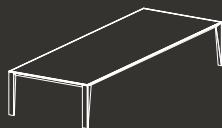

L *240/300 - P 120 cm
W *94 1/2"-118 1/8" D 47 1/4"

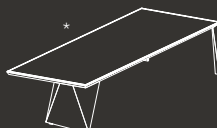

*

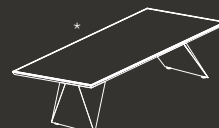

*

Tavolini da caffè | Coffee tables | Tables basses | Mesitas



H 40 cm
H 15 3/4"

L/P 60 cm L 120 - P 60 cm
W/D 23 5/8" W 47 1/4" - D 23 5/8"



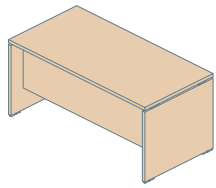

78
Atlante

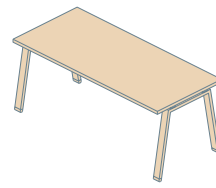

86
Ateo

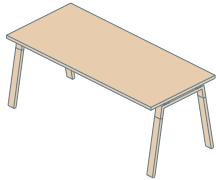

96
Ateo Wood

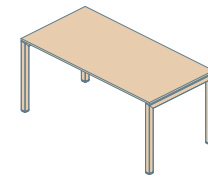

104
Italo_forty

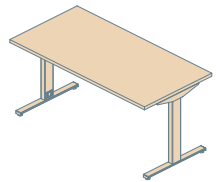

112
Ortho

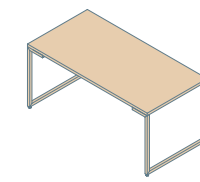

120
Ibis

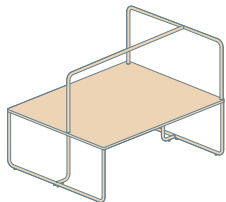

128
Itube

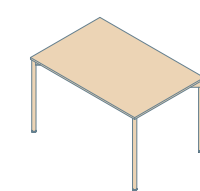

140
Rendez-Vous

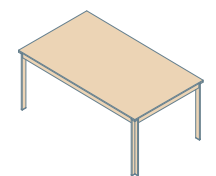

150
Zefiro

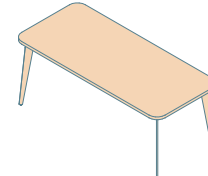

158
Blade

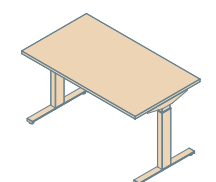

166
Crono



operativi



Atlante

Atlante è un sistema di workstation composto da pareti strutturali, disponibili anche nella versione di altezza 120 cm con applicazione in tessuto acustico puntaspilli, attrezzabili con corpetti contenitori ad ante scorrevoli in acrilico e melaminico.

Atlante propone anche workstation sagomate a 90° e 120° e contenitori laterali H 120 cm, utili per la archiviazione di documenti di frequente consultazione. Ciascun elemento (gamba, top, parete, struttura e fronte dei contenitori) può avere un colore diverso permettendo una forte personalizzazione.

Piano
Top
Plateau
Sobre



Struttura
Structure
Structure
Estructura



Screen
Screen
Écran
Panel



Atlante is a workstation system made of structural panels, also available in the version 120 cm (47 1/4") high with fabric acoustic/tackable application. It can be accessorized by overheads with acrylic or Italian melamine sliding doors.

Atlante also offers 90° and 120° shaped workstations and H 120 cm (47 1/4") lateral storage units, useful for storing daily paperwork. Each component (leg, top, panel and storage fronts) can have a different color allowing a wide customization.

Atlante est un système de poste de travail composé de panneaux structuraux, également disponibles dans la version avec panneaux de 120 cm de hauteur avec application en tissu acoustique punaisable, peuvent être équipés de modules-rangement avec porte coulissante en acrylique et mélaminé.

Atlante propose également des postes de travail façonnés à 90° et 120° et des conteneurs latéraux H 120 cm, utiles pour l'archivage de documents fréquemment consultés. Chaque élément (pied, plateau, panneau, structure et façade des conteneurs) peut avoir une couleur différente permettant une forte personnalisation.

Atlante es un sistema de estaciones de trabajo compuesto por biomboes estructurales, disponibles también en la versión con una altura de 120 cm y aplicación en tejido acústico pinchable, se pueden equipar con contenedores con puertas corredizas en acrílico y melamina.

Atlante propone también workstations de 90° y 120° y contenedores laterales H 120 cm, útiles para el archivo de documentos que se consultan con frecuencia. Cada elemento (pata, pared, estructura y frente de los contenedores) puede tener un color diferente permitiendo una fuerte personalización.

adaptable
modular
extensive



Atlante. collection



Sale riunioni
Meeting rooms
Salles de réunion
Salas de reuniones

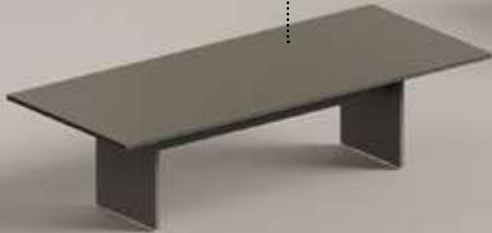

Tavolini
Coffee tables
Tables basses
Mesitas



Uffici privati
Private offices
Bureaux privés
Oficinas privadas



Workstations
Workstations
Poste de travail
Estación de trabajo



1.



2.

1. Workstation 90° | 90° workstation | Station de travail 90° |
Estación de trabajo 90° **Fin.** MC, MZ, EZ
L 160 **P** 160 cm | **W** 63" **D** 63"

2. Workstation 90° | 90° workstation | Station de travail 90° |
Estación de trabajo 90° **Fin.** MN, MC
L 160 **P** 160 cm | **W** 63" **D** 63"

3. Scrivania | Desk | Bureau | Mesa **Fin.** ME
L 180 **P** 90 cm | **W** 70 7/8" **D** 35 3/8"

Dattilo | Return | Retour | Ala
L 120 **P** 60 cm | **W** 47 1/4" **D** 23 5/8"

Tavolino da caffè | coffee table | table basse | mesita
L/P 60 cm | **W/D** 23 5/8"

4. Composizione | Composition | Composition | Composición
Fin. MN, MC **L** 360 **P** 400 cm | **W** 141 3/4" **D** 157 1/2"

5. Composizione | Composition | Composition | Composición
Fin. MN, MI **L** 530 **P** 300 cm | **W** 208 5/8" **D** 118 1/8"



3.



4.



Piani e gambe | Desk tops and legs | Plateaux et pieds | Sobres y patas

	<p>Spessore 3 cm 3 cm (1 1/4") thick 3 cm d'épaisseur 3 cm de espesor</p>		<p>Gamba esterna filopiano Side flush-fitting panel leg Pied terminaux à fleur plateau Costado rasado tapa mesas</p>		<p>Paretina con pannello in tessuto puntaspilli applicato Side leg with tackable panel applied Cloison terminal avec panneau punaisable Biombo terminal con panel en tejido pinchable</p>
			<p>Gamba sottopiano Panel leg under top Pied sous plateau Costado bajo tapa mesas</p>		

Scrivanie | Desks | Bureaux | Mesas

H 73,4 cm
H 29

L 120/140/160/180/200 - **P** 80 cm/**L** 180/200 - **P** 90 cm
W 47 1/4"-55 1/8"-63"-70 7/8"-78 3/4" - **D** 31 1/2" - **W** 70 7/8"-78 3/4" - **D** 35 3/8"

Dattilo | Returns | Retours | Alas

H 73,4 cm
H 29

L 80/100/120 - **P** 60 cm
W 31 1/2"-39 3/8"-47 1/4" - **D** 23 5/8"

Tavoli riunione | Meeting tables | Tables de réunion | Mesas de juntas

<p>H 73,4 cm H 29</p> <p>Ø 100/120 cm Ø 39 3/8"-47 1/4"</p>	<p>L 210/280 - P 120 cm W 82 5/8"-110 1/4" - D 47 1/4"</p>
---	--

Tavolini da caffè | Coffee tables | Tables basses | Mesitas

<p>H 40 cm H 15 3/4"</p> <p>L/P 60 cm W/D 23 5/8"</p>	<p>L 120 - P 60 cm W 47 1/4" - D 23 5/8"</p>
---	--

Esempi composizioni | Composition example | Exemples de compositions | Ejemplos de composiciones

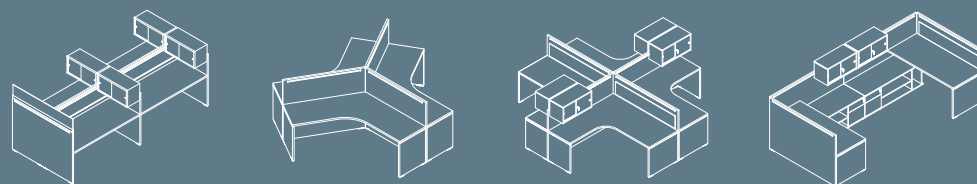

Atreo

Atreo è un sistema molto versatile che offre soluzioni ideali per le postazioni lavoro singole o multiple.

I contenitori laterali strutturali possono essere dotati di cuscino. Le gambe hanno varie forme, aperte o ad anello. Sono disponibili anche workstation con piani sagomati e angoli arrotondati.

Peculiarità di Atreo sono anche le console, disponibili sia nella versione mobile che fissa, offrono ampio spazio per agganciare i monitor e nascondere il cablaggio.

Atreo is a versatile system that offers ideal solutions for single or multiple workstations.

Structural side storage units can be equipped with a cushion. Legs are available in various shapes, open or loop legs. Workstations with shaped tops and rounded corners are also available.

Atreo peculiarity are also the media consoles, available in both mobile and fixed versions, providing enough space to mount monitors and hide wiring.

Atreo est un système très polyvalent qui offre des solutions idéales pour des postes de travail individuels ou multiples.

Les meubles retour structurels peuvent être équipés d'un coussin. Les piétements existent en 3 versions : trapèze, droit ou anneau. Des postes de travail avec des plateaux façonnés avec coins arrondis sont également disponibles.

Particularités d'Atreo sont également les cloisons techniques, disponibles dans les versions mobile et fixe, ils offrent beaucoup d'espace pour connecter les écrans et masquer le câblage.

Atreo es un sistema muy versátil que ofrece soluciones ideales para estaciones de trabajo individuales o multiples.

Los muebles laterales estructurales se pueden equipar con un cojín. Las patas tienen varias formas, abiertas o en un anillo. Están disponible también estaciones de trabajo con sobres en forma y esquinas redondeadas.

Peculiaridades de Atreo también son las consolas, disponibles tanto en la versión móvil como fija y ofrecen un amplio espacio para conectar monitores y ocultar el cableado.

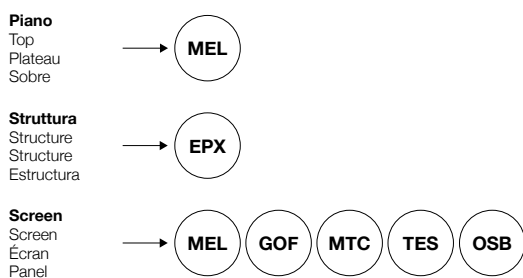

must-have
shapes
fresh





Atreo. collection



Tavolini
Coffee tables
Tables basses
Mesitas



Contenitori
Cabinets
Rangements
Contenedores



Sale riunioni
Meeting rooms
Salles de réunion
Salas de reuniones



Condivisione
Sharing
Partage
Compartir



Uffici privati
Private offices
Bureaux privés
Oficinas privadas



Workstations
Workstations
Poste de travail
Estación de trabajo





1.



2.



3.



5.



6.



1. Bench | Bench | Bench | Bench **Fin.** MN
L 200 P 163 cm | W 78 3/4" D 64 1/8"

2. Bench | Bench | Bench | Bench **Fin.** MN, MD, FU, EI
L 400 P 163 cm | W 70 7/8" D 70 7/8"

Mobile di servizio | Service unit | Meuble retour | Mueble de servicio
L 160 P 58 cm | W 63" D 22 7/8"

3. Bench | Bench | Bench | Bench **Fin.** MK, OSB, EO
L 200 P 163 cm | W 78 3/4" D 64 1/8"

4. Tavolo | Table | Table | Mesa **Fin.** MI, EK
L 420 P 120 cm | W 165 3/8" D 47 1/4"

5. Composizione 120° | 120° composition | Composition 120° |
Composición 120° **Fin.** MT, ET
L 680 P 360 cm | W 267 3/4" D 141 3/4"

6. Scrivania | Desk | Bureau | Mesa **Fin.** ME, EI
L 200 P 90 cm | W 78 3/4" D 35 3/8"

Mobile di servizio | Service unit | Meuble retour | Mueble de servicio
L 160 P 58 cm | W 63" D 22 7/8"

7. Bench | Bench | Bench | Bench **Fin.** ML, OSB, EN
L 600 P 163 cm | W 236 1/4" D 64 1/8"

8. Console | Console | Console | Consola **Fin.** MN, MI, EO
L 180 P 90 H 105 cm | W 70 7/8" D 35 3/8" H 41 3/8"

Piani | Desk tops | Plateaux | Sobres

Spessore 3 cm | 3 cm (1 1/4") thick | 3 cm d'épaisseur | 3 cm de espesor



Con angoli dritti

With straight corners
Avec coins droits
Con esquinas rectas



Con angoli raggiati

With rounded corners
Avec coins arrondis
Con esquinas redondeadas

Gambe | Legs | Pieds | Patas

Sezione 7x3 cm | Section 7x3 cm (2 3/4"x1 1/4") | Section 7x3 cm | Sección 7x3 cm



A cavalletto

A-shape
Tréteau
Caballette

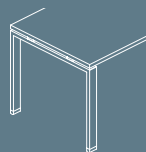

A ponte

Straight
Droit
Recta

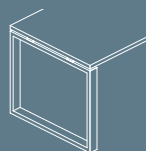

Ad anello

Closed loop
En anneau
Anillo

Scrivanie | Desks | Bureaux | Mesas

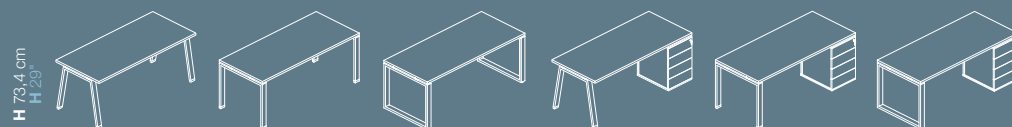

H 73.4 cm
H 29"

L 120/140/160/180/200 - P 80 cm / L 180/200 - P 90 cm
W 47 1/4"-55 1/8"-63"-70 7/8"-78 3/4"- D 31 1/2" - W 70 7/8"-78 3/4"- D 35 3/8"

Dattilo | Returns | Retours | Alas

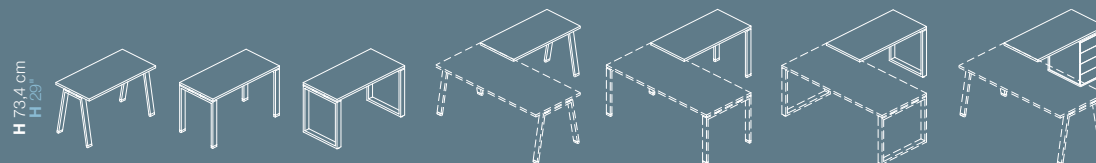

H 73.4 cm
H 29"

L 80/100/120 - P 60 cm
W 31 1/2"-39 3/8"-47 1/4" - D 23 5/8"

Tavoli riunione | Meeting tables | Tables de réunion | Mesas de juntas

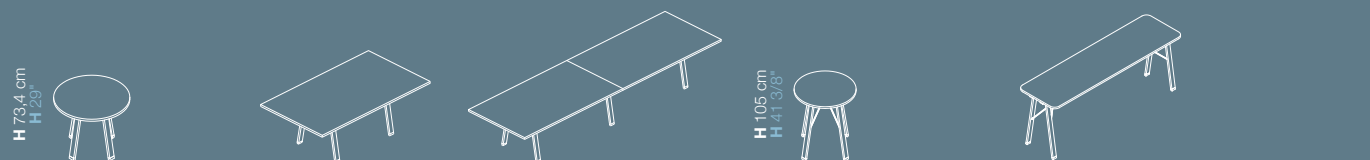

H 73.4 cm
H 29"

H 105 cm
H 41 3/8"

Ø 90/100/120/130/150 cm
Ø 35 3/8"-39 3/8"-47 1/4"-
51 1/8"-59"

L 210/280 - P 120 cm
W 82 5/8"-110 1/4" -
D 47 1/4"

L 420/560 - P 120 cm
W 165 3/8"-220 1/2" - D 47 1/4"

Ø 90/100/120/130/150 cm
Ø 35 3/8"-39 3/8"-47 1/4"-
51 1/8"-59"

L 140/160/180/200/220/240/260/280 - P 60/80 cm
W 55 1/8"-63"-70 7/8"-78 3/4"-86 5/8"-94 1/2"-
102 3/8"-110 1/4" - D 23 5/8"-31 1/2"

Tavolini da caffè | Coffee tables | Tables basses | Mesitas



H 40 cm
H 15 3/4"

L/P 60 cm
W/D 23 5/8"

L 120 - P 60 cm
W 47 1/4" - D 23 5/8"

Mobili di servizio | Service units | Meuble retour | Muebles de servicio



H 54 cm
H 21 1/4"

L 160 - P 58 cm
W 63" - D 22 7/8"

Esempi composizioni | Composition example | Exemples de compositions | Ejemplos de composiciones

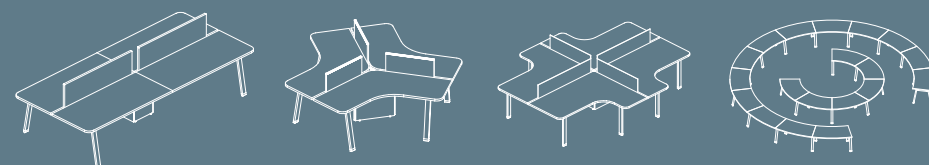





Atreo Wood

Il sistema operativo Atreo con gamba metallica presenta ora un' interessante opzione per la versione con gamba a cavalletto.

La parte inferiore della gamba è disponibile con inserto in legno massello rovere chiaro, a creare una nuova originale combinazione di materiali complementari.

Atreo operative system with metal leg now has an interesting option for the version with A-shaped leg.

The lower portion of the leg is available in light oak solid wood, to create a new, original mix of blending materials.

La collection Atreo avec sa structure métallique est maintenant doté d'une option intéressante avec la version pied trapèze

Ces piétements sont équipés d'un insert en ébénisterie en finition chêne naturel, en créant une combinaison originale de matériaux complémentaires.

El sistema operativo Atreo con pata metálica presenta ahora una opción interesante para la versión con pata de caballete.

La parte inferior de la pata está disponible con inserción de madera maciza roble claro, para crear una nueva combinación original de materiales complementarios.

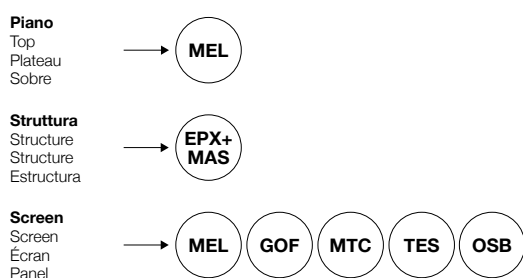

organic
balance
curves



Atreo Wood. collection



Uffici privati
Private offices
Bureaux privés
Oficinas privadas



Contenitori
Cabinets
Rangements
Contenedores



Condivisione
Sharing
Partage
Compartir



Workstations
Workstations
Poste de travail
Estación de trabajo



Sale riunioni
Meeting rooms
Salles de réunion
Salas de reuniones







2.

1. Bench | Bench | Bench | Bench **Fin.** MN, EB, DC
L 180 **P** 163 cm | **W** 70 7/8" **D** 64 1/8"

2. Tavolo | Table | Table | Mesa **Fin.** MZ, EZ
L 280 **P** 120 cm | **W** 110 1/4" **D** 47 1/4"

3. Tavolo | Table | Table | Mesa **Fin.** MI, EO, MZ, EZ, MT, ET
Ø 120 **H** 105 cm | **Ø** 47 1/4" **H** 41 3/8"

4. Tavolo | Table | Table | Mesa **Fin.** MI, EO
L 280 **P** 80 **H** 105 cm | **W** 110 1/4" **D** 31 1/2" **H** 41 3/8"

5. Bench | Bench | Bench | Bench **Fin.** MI, EB, MZ
L 320 **P** 163 cm | **W** 126" **D** 64 1/8"



3.



4.



Piani | Desk tops | Plateaux | Sobres

Spessore 3 cm | 3 cm (1 1/4") thick | 3 cm d'épaisseur | 3 cm de espesor



Con angoli dritti
With straight corners
Avec coins droits
Con esquinas rectas



Con angoli raggiati
With rounded corners
Avec coins arrondis
Con esquinas redondeadas

Gambe | Legs | Pieds | Patas

Sezione 7x3 cm | Section 7x3 cm (2 3/4"x1 1/4") | Section 7x3 cm | Sección 7x3 cm



A cavalletto
A-shape
Tréteau
Caballete

Scrivanie | Desks | Bureaux | Mesas



H 73.4 cm
H 29"

L 120/140/160/180/200 - P 80 cm / L 180/200 - P 90 cm
W 47 1/4"-55 1/8"-63"-70 7/8"-78 3/4" - D 31 1/2" - W 70 7/8"-78 3/4" - D 35 3/8"

Dattilo | Returns | Retours | Alas

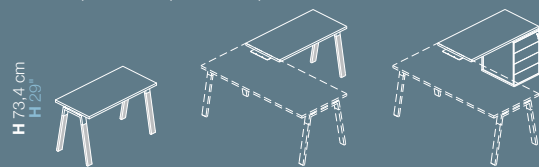

H 73.4 cm
H 29"

L 80/100/120 - P 60 cm
W 31 1/2"-39 3/8"-47 1/4" - D 23 5/8"

Tavoli riunione | Meeting tables | Tables de réunion | Mesas de juntas

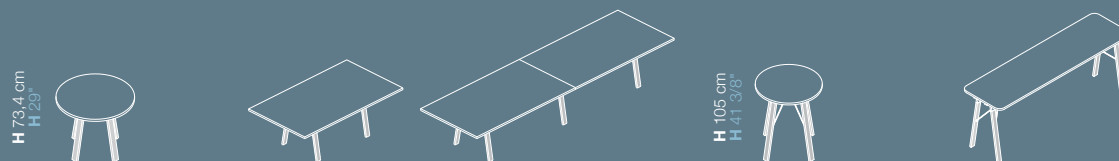

H 73.4 cm
H 29"

H 105 cm
H 41 3/8"

Ø 90/100/120/130/150 cm
Ø 35 3/8"-39 3/8"-47 1/4"-
51 1/8"-59"

L 210/280 - P 120 cm
W 82 5/8"-110 1/4" -
D 47 1/4"

L 420/560 - P 120 cm
W 165 3/8"- 220 1/2" - D 47 1/4"

Ø 90/100/120/130/150 cm
Ø 35 3/8"-39 3/8"-47 1/4"-
51 1/8"-59"

L 140/160/180/200/220/240/260/280 - P 60/80 cm
W 55 1/8"-63"-70 7/8"-78 3/4"-86 5/8"-94 1/2"-102 3/8"-
110 1/4" - D 23 5/8"-31 1/2"

Mobili di servizio | Service units | Meuble retour | Muebles de servicio



H 54 cm
H 21 1/4"

L 160 - P 58 cm
W 63" - D 22 7/8"

Esempi composizioni | Composition example | Exemples de compositions | Ejemplos de composiciones

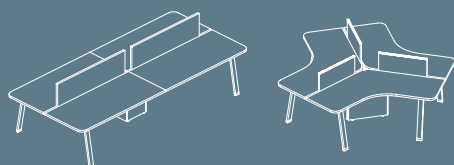

Italo_forty

Italo_forty è un sistema dalle sorprendenti prerogative tecniche ma dai costi contenuti.

Il sistema si compone di una struttura metallica trave/cavalletto di supporto a piani di spessore 18 mm.

I piani possono essere sia fissi che traslabili, permettendo così un comodo accesso al cestello per la gestione dei cavi. Italo_forty consente inoltre di realizzare tavoli con campata sino a 300 cm senza l'ausilio di supporti intermedi.

Italo_forty system combines great technical features with cost efficient components.

A metal structure with horizontal beams and straight legs, supports tops 18 mm (3/4") thick.

Tops can be either fixed or sliding, allowing easy access to the basket for cable management. With Italo_forty it is also possible to create tables up to 300 cm (118 1/8") long, without the use of intermediate supports.

Italo_forty est un système aux surprenantes caractéristiques techniques mais au prix contenu.

Le système se compose d'une structure métallique poutre/pied droit à support de plateaux de 18 mm d'épaisseur.

Les plateaux peuvent être fixes ou mobiles, ce qui permet un accès facile au panier pour la gestion des câbles. Italo_forty permet également de créer des tables avec largeur jusqu'à 300 cm sans l'aide de supports intermédiaires.

Italo_forty es un sistema de sorprendentes características técnicas a un precio razonable.

El sistema consta de una estructura metálica de patas/vigas que soporta superficies de 18 mm de espesor.

Los sobres pueden ser tantos fijos como móviles y permiten así un cómodo acceso a la viga por el manejo de los cables. Italo_forty permite además de realizar mesas hasta los 300 cm de largo sin el uso de apoyos intermedios.

Piano
Top
Plateau
Sobre



Struttura
Structure
Structure
Estructura



Screen
Screen
Écran
Panel



easy
essential
linear





Italo_forty. collection



Uffici privati
Private offices
Bureaux privés
Oficinas privadas



Workstations
Workstations
Poste de travail
Estación de trabajo



Sale riunioni
Meeting rooms
Salles de réunion
Salas de reuniones







1. Bench | Bench | Bench | Bench **Fin.** MD, EB
L 160 **P** 163 cm | **W** 63" **D** 64 1/8"

2. Bench | Bench | Bench | Bench **Fin.** MK, MI, EB
L 360 **P** 163 cm | **W** 141 3/4" **D** 64 1/8"

3. Tavolo | Table | Table | Mesa **Fin.** MZ, EE
L 280 **P** 123 cm | **W** 110 1/4" **D** 48 3/8"

4. Tavolo | Table | Table | Mesa **Fin.** MW, EB
L 960 **P** 123 cm | **W** 378" **D** 48 3/8"



2.





Piani | Desk tops | Plateaux | Sobres



Melaminico spessore 3 cm/vetro spessore 0,8 cm
Italian melamine 3 cm (1 1/4") thick/glass 0,8 cm (1/4") thick
Mélaminé 3 cm d'épaisseur/verre 0,8 cm d'épaisseur
Melamina 3 cm de espesor/vidrio 0,8 cm de espesor

Gambe | Legs | Pieds | Patas

Sezione 4x4 cm | Section 4x4 cm (1 5/8"x 1 5/8") | Section 4x4 cm | Sección 4x4 cm



Sezione quadrata

Square section
Section carrée
Sección cuadrada

Scrivanie | Desks | Bureaux | Mesas



H 73,4 cm
H 29"

L 100/120/140/160/180/200 - P 80 cm/L 180/200 - P 90 cm
W 39 3/8"-47 1/4"-55 1/8"-63"-70 7/8"-78 3/4" - D 31 1/2" - W 70 7/8"-78 3/4" - D 35 3/8"

Dattilo | Returns | Retours | Alas

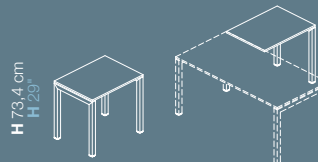

H 73,4 cm
H 29"

L 80/100/120 - P 60 cm
W 31 1/2"-39 3/8"-47 1/4" - D 23 5/8"

Tavoli riunione | Meeting tables | Tables de réunion | Mesas de juntas



H 73,4 cm
H 29"

L 120/160 - P 123/163 cm
W 47 1/4"-63" - D 48 3/8"-64 1/8"

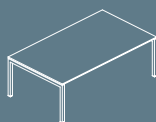

L 210/240/300 - P 123 cm
W 82 5/8"-94 1/2"-118 1/8" - D 48 3/8"

Esempi composizioni | Composition example | Exemples de compositions | Ejemplos de composiciones

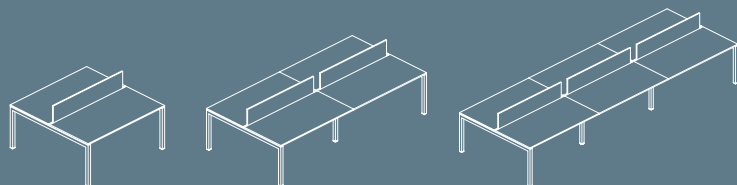



Ortho

Il sistema di scrivanie Ortho si caratterizza per la possibilità di scegliere piani da 18 o 30 mm.

Le due gambe sono collegate da una trave strutturale. Attraverso il montante il cablaggio transita da terra fino al piano scrivania, entrando e fuoriuscendo da appositi accessi passacavi.

The Ortho desking system features the possibility to choose 18 or 30 mm (3/4" or 1 1/4") thick tops.

The two legs are connected by a structural metal beam. Through the upright, wires transit from the floor up to the desk top, coming in and out from dedicated grommets.

Le système de bureau Ortho se caractérise par la possibilité de choisir des plateaux avec un épaisseur de 18 ou 30 mm. Le câblage passe du sol au bureau à travers le montant, pour entrer ou sortir par les accès appropriés.

El sistema de mesas Ortho se caracteriza para la posibilidad de elegir sobres de 18 o 30 mm de grosor.

Las dos patas están conectadas entre ellas por una viga estructural. A través de la columna vertical, el cableado transita del suelo hasta el sobre mesa, entrando y saliendo de los apropiados huecos pasacables.

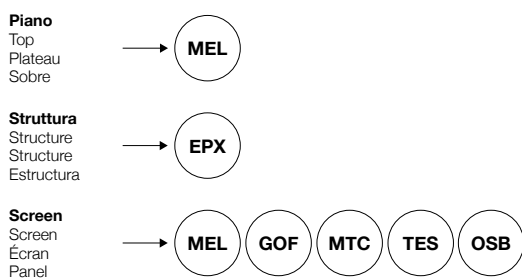

simple
technical
pragmatic



Ortho. collection



Workstations
Workstations
Poste de travail
Estación de trabajo



Uffici privati
Private offices
Bureaux privés
Oficinas privadas



Sale riunioni
Meeting rooms
Salles de réunion
Salas de reuniones



Divisori
Dividers
Séparateurs
Separadores

→ p. 210





3.

1. Composizione 90° | 90° composition | Composition 90° |
Composición 90° **Fin.** MN, EB, DD
L 363 P 363 cm | W 142 7/8" D 142 7/8"

2. Scrivania | Desk | Bureau | Mesa **Fin.** ME, EI
L 200 P 90 cm | W 78 3/4" D 35 3/8"
Dattilo | Return | Retour | Ala
L 100 P 60 cm | W 39 3/8" D 23 5/8"

3. Scrivania | Desk | Bureau | Mesa **Fin.** MN, MK, MJ, YV, DC
L 180 P 80 cm | W 70 7/8" D 31 1/2"

4. Tavolo | Table | Table | Mesa **Fin.** ML, EN
L 200 P 120 cm | W 78 3/4" D 47 1/4"

5. Tavolo | Table | Table | Mesa **Fin.** MK, EB
L 600 P 120 cm | W 236 1/4" D 47 1/4"

6. Scrivania | Desk | Bureau | Mesa **Fin.** MT, ET, DC, DH
L 160 P 80 cm | W 63" D 31 1/2"



4.



5.



6.

Spessore 3 cm
3 cm thick (1 1/4")
3 cm d'épaisseur
3 cm de espesor

Spessore 1,8 cm
1,8 cm thick (3/4")
1,8 cm d'épaisseur
1,8 cm de espesor



Struttura in metallo elettrificata, regolabile in altezza manualmente
Electrified metal structure, manually height-adjustable
Structure en métal électrifiée, réglable manuellement en hauteur
Estructura metálica electrificada, regulable manualmente en altura

Piano da 18 mm | 18 mm (3/4") top | Plateau ép. 18 mm | Sobre mesa de 18 mm de grosor

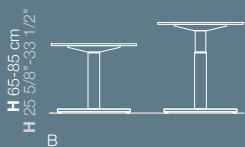

A) Struttura fissa, B) Struttura regolabile
A) Fixed structure, B) Height-adjustable structure
A) Structure fixe, B) Structure réglable en hauteur
A) Estructura con altura fija, B) Estructura con altura regulable

Piano da 30 mm | 30 mm (1 1/4") top | Plateau ép. 30 mm | Sobre mesa de 30 mm de grosor



A) Struttura fissa, B) Struttura regolabile
A) Fixed structure, B) Height-adjustable structure
A) Structure fixe, B) Structure réglable en hauteur
A) Estructura con altura fija, B) Estructura con altura regulable

Scrivanie | Desks | Bureaux | Mesas



L 120/140/160/180/200 - P 80 cm/L 180/200 - P 90 cm
W 47 1/4"-55 1/8"-63"-70 7/8"-78 3/4" - D 31 1/2" - W 70 7/8"-78 3/4" - D 35 3/8"

Dattilo | Returns | Retours | Alas

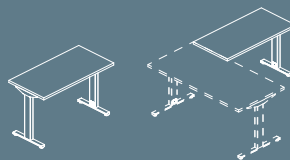

L 80/100/120 - P 60 cm
W 31 1/2"-39 3/8"-47 1/4" - D 23 5/8"

Workstation | Workstations | Workstation | Workstation



L 160/180 - P 160/180 cm
W 63"-70 7/8" - D 63"-70 7/8"

Paretine | full-height panels | cloisons | biombos



L 60/70/80/90/100 cm
W 23 5/8"-27 1/2"-31 1/2"-35 3/8"-39 3/8"

Tavoli riunione | Meeting tables | Tables de réunion | Mesas de juntas



L/P 120 cm
W/D 47 1/4"



L 200 - P 120 cm
W 78 3/4 - D 47 1/4"

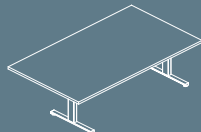

L 210/280 - P 120 cm
W 82 5/8"-110 1/4" - D 47 1/4"

Ibis

Ibis ha una struttura portante leggera ed elegante.

Il suo design è caratterizzato dalle gambe ad anello piegate verso l'interno, realizzate con un profilo in metallo a sezione quadrata di 30 mm.

Tra le caratteristiche architettoniche principali troviamo le grandi superfici di lavoro singole e doppie che vanno a coprire le cassettiere strutturali, disponibili in diverse larghezze. Un altro dettaglio unico di Ibis sono i contenitori laterali che possono essere sospesi a giorno, oppure indipendenti con vani sia chiusi che aperti.

Ibis has a light and elegant supporting structure.

Its design features ring legs folded towards the inside manufactured from steel square section 30 mm (1 1/4") thick.

Among the main architectural features we find the large single and double work surfaces that cover structural drawers, available in different widths. Other unique details are the side storage units that can be hanging or freestanding.

Ibis a une structure porteuse légère et élégante.

Le délicat travail de pliage du piétement à section carrée, 30 mm, lui confère un design pur et élégant.

Parmi les principales caractéristiques architecturales, on peut citer les grandes surfaces de travail simples et doubles qui recouvrent les éléments structuraux des tiroirs, disponibles en différentes largeurs. Un autre détail unique d'Ibis sont les rangements latéraux suspendus avec compartiments ouverts ou indépendants.

Ibis tiene una estructura de soporte ligera y elegante. Su diseño se caracteriza por la pata de anillo plegado hacia el interior, realizada con un perfil de acero de sección cuadrada de 30 mm.

Entre las principales características arquitectónicas se encuentran grandes superficies de trabajo individuales y dobles que cubren las cajoneras estructurales, disponibles en diferentes anchos. Otro detalle de Ibis son los contenedores laterales que pueden ser abiertos y colgados a la mesa o independientes con módulos cerrados y abiertos.

Piano
Top
Plateau
Sobre



Struttura
Structure
Structure
Estructura



Screen
Screen
Écran
Panel



slim
minimalistic
linear





Ibis. collection



Condivisione
Sharing
Partage
Compartir



Contenitori
Cabinets
Rangements
Contenedores

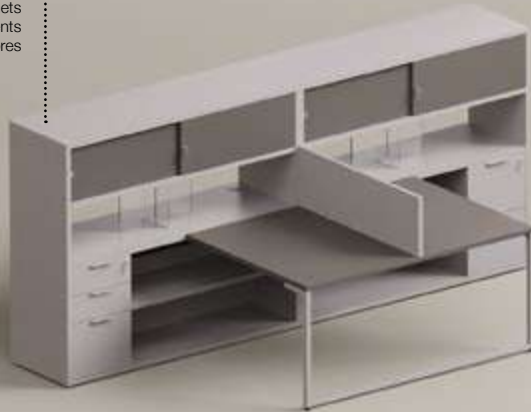

Sale riunioni
Meeting rooms
Salles de réunion
Salas de reuniones



Workstations
Workstations
Poste de travail
Estación de trabajo



Uffici privati
Private offices
Bureaux privés
Oficinas privadas



Tavolini
Coffee tables
Tables basses
Mesitas





1. Bench | Bench | Bench | Bench **Fin.** MK, DH, YC
L 190 **P** 160 cm | **W** 74 3/4" **D** 63"

2. Bench | Bench | Bench | Bench **Fin.** MI, MY, DI, EO
L 230 **P** 160 cm | **W** 90 1/2" **D** 63"

3. Scrivania | Desk | Bureau | Mesa **Fin.** TR, ET
L 200 **P** 90 cm | **W** 78 3/4" **D** 35 3/8"

4. Bench | Bench | Bench | Bench **Fin.** MI, OSB, EB
L 320 **P** 160 cm | **W** 126" **D** 63"





4.

Piani | Desk tops | Plateaux | Sobres



Melaminico spessore 3 cm/vetro spessore 0,8 cm
 Italian melamine 3 cm (1 1/4") thick/glass 0,8 cm (1/4") thick
 Mélaminé 3 cm d'épaisseur/verre 0,8 cm d'épaisseur
 Melamina 3 cm de espesor/vidrio 0,8 cm de espesor

Gambe | Legs | Pieds | Patas

Sezione 3x3 cm | Section 3x3 cm (1 1/4"x1 1/4") | Section 3x3 cm | Sección 3x3 cm

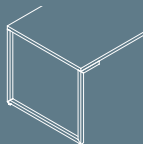

Ad L
 L-shape
 Pied en L
 Pata en L



A X
 X-shape
 Pied en X
 Pata en X

Scrivanie | Desks | Bureaux | Mesas

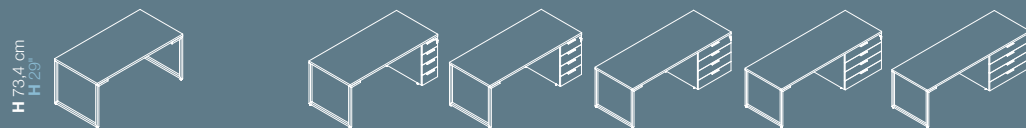

H 73,4 cm
 H 29"

L 120/140/160/180/200 - P 80 cm/L 180/200 - P 90 cm
 W 47 1/4"-55 1/8"-63"-70 7/8"-78 3/4"- D 31 1/2" - W 70 7/8"-78 3/4"- D 35 3/8"

Disponibili con cassettera strutturale in diverse dimensioni
 Available with structural drawer unit in various dimensions
 Disponible avec caisson porteur en différentes dimensions
 Disponible con bucs estructurales en diferentes tamaños

Dattilo | Returns | Retours | Alas

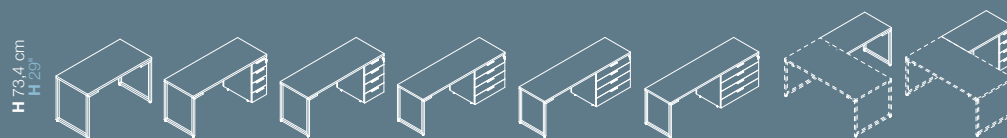

H 73,4 cm
 H 29"

L 80/100/120 - P 60 cm
 W 31 1/2"-39 3/8"-47 1/4"- D 23 5/8"

Disponibili con cassettera strutturale in diverse dimensioni
 Available with structural drawer unit in various dimensions
 Disponible avec caisson porteur en différentes dimensions
 Disponible con bucs estructurales en diferentes tamaños

Bench | Bench | Bench | Bench

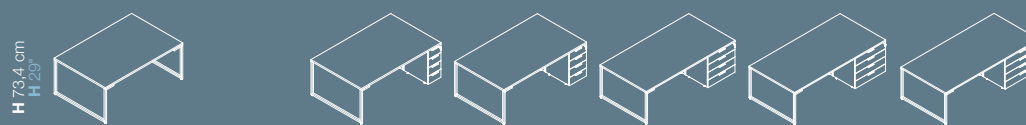

H 73,4 cm
 H 29"

L 120/140/160/180/200 - P 120/160 cm
 W 47 1/4"-55 1/8"-63"-70 7/8"-78 3/4" - D 47 1/4"-63"

Disponibili con cassettera strutturale in diverse dimensioni
 Available with structural drawer unit in various dimensions
 Disponible avec caisson porteur en différentes dimensions
 Disponible con bucs estructurales en diferentes tamaños

Tavoli riunione | Meeting tables | Tables de réunion | Mesas de juntas



H 73,4 cm
 H 29"

H 105 cm
 H 41 3/8"

Ø 100/120/150 cm
 Ø 39 3/8"-47 1/4"-59"

L/P 120 cm
 W/D 47 1/4"

L 210/280 - P 120 cm
 W 82 5/8"-110 1/4" - D 47 1/4"

L 350 - P 120 cm
 W 137 3/4" - D 47 1/4"

Ø 100/120/150 cm
 Ø 39 3/8"-47 1/4"-59"

Tavolini da caffè | Coffee tables | Tables basses | Mesitas



H 40 cm
 H 15 3/4"

L/P 60 cm
 W/D 23 5/8"

L 120 - P 60 cm
 W 47 1/4" - D 23 5/8"

Contenitore sospeso | Hanging storage unit | Rangement suspendu | Contenedor suspendido

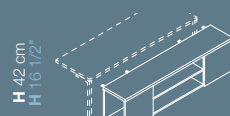

H 42 cm
 H 16 1/2"

L 160 - P 33 cm
 W 63" - D 13"

Contenitori laterali | Lateral storage units | Rangements latérales | Contenedores laterales

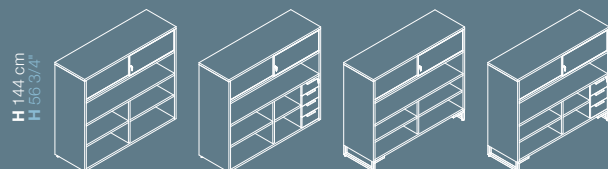

H 144 cm
 H 56 3/4"

L 163/183/203 - P 53 cm
 W 64 1/8"-72"-79 7/8" - D 20 7/8"

Disponibili con cassettera strutturale in diverse dimensioni
 Available with structural drawer unit in various dimensions
 Disponible avec caisson porteur en différentes dimensions
 Disponible con bucs estructurales en diferentes tamaños



Itube

Itube è una collezione operativa in cui l'estetica diventa funzione, perfetto per ambienti coworking dal taglio fresco e dinamico.

La sua struttura è definita da un segno continuo che interseca e sostiene il piano, rendendo armoniosa la struttura. Il profilo tubolare è di diametro 35 mm e funge da gamba o da arco decorativo. I piani possono essere realizzati in melaminico o Fenix®.

Itube nasce come bench, ma completa la sua linea anche con scrivanie e tavoli riunione. La collezione è dotata di diverse tipologie di accessori: mensole, portapiante, vani portaoggetti e cassetti. Viene introdotta per la prima volta la tenda come elemento dinamico per creare e separare postazioni di lavoro.



Selezione Compasso d'Oro

Piano
Top
Plateau
Sobre



Struttura
Structure
Structure
Estructura



Screen
Screen
Écran
Panel

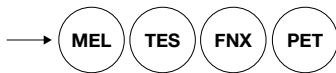

Itube is an operative collection where beauty meets function, perfect for fresh and dynamic coworking environments.

The tubular structure is the hallmark of this collection and gives a harmonious image, intersecting and supporting the top. The tops can be made of melamine or Fenix®.

Itube was created as a shared solution, but completes the proposal with desks and meeting tables. The collection is enriched with different types of accessories: shelves, plant trays, storage compartments and drawers. The curtain is introduced for the first time in this collection as a dynamic element to create and separate workstations.

Itube est une collection opérationnelle où l'esthétique devient fonction, parfaite pour les environnements de coworking à l'allure fraîche et dynamique.

Sa structure est définie par une ligne continue qui croise et soutient le plateau, rendant la structure harmonieuse. Le profil tubulaire de 35 mm de diamètre a un rôle de pied ou d'arche décoratif. Les plateaux peuvent être réalisés en mélamine ou en Fenix®.

Itube est né comme bench, mais complète sa ligne avec bureaux et tables de réunion. La collection est dotée de différents types d'accessoires: étagères, cache-pots, compartiments de rangement et tiroirs. Le rideau est introduit pour la première fois en tant qu'élément dynamique pour créer et séparer les postes de travail.

Itube es una colección operativa, donde la estética se convierte en función, perfecta para entornos de coworking con un estilo fresco y dinámico.

Su estructura está definida por una línea continua que se cruza y soporta el sobre, haciendo que la estructura sea armoniosa. El perfil tubular tiene 35 mm de diámetro y sirve como pata o arco decorativo. Las encimeras pueden ser de melamina o Fenix®.

Itube nace como bench, pero completa su línea también con escritorios y mesas de reuniones. La colección está equipada con distintos tipos de accesorios: estantes, jardineras, compartimentos de almacenamiento y cajones. Se introduce por primera vez la cortina como elemento dinámico para crear y separar puestos de trabajo.

funky
aesthetics
iconic



Itube. collection



Uffici privati
Private offices
Bureaux privés
Oficinas privadas



Workstations
Workstations
Poste de travail
Estación de trabajo



Sale riunioni
Meeting rooms
Salles de réunion
Salas de reuniones





1.



2.

3.









Piani | Desk tops | Plateaux | Sobres

Spessore 3 cm | 3 cm (1 1/4") thick | 3 cm d'épaisseur | 3 cm de espesor

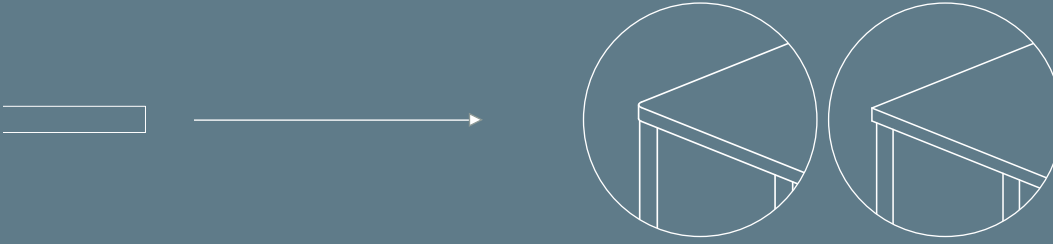

Scrivanie/tavoli | Desks/tables | Bureaux/tables | Mesas

Dattilo | Returns | Retours | Alas

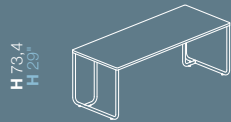

H 73.4
H 29"

L 120/140/160/180/200 - P 80 cm / L 180/200 - P 90 cm
W 47 1/4"-55 1/8"-63"-70 7/8"-78 3/4" - D 31 1/2" - W 70 7/8"-78 3/4" - D 35 1/2"

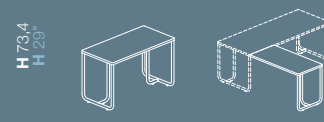

H 73.4
H 29"

L 80/100/120 - P 60 cm
W 31 1/2"-39 3/8"-47 1/4" - D 23 5/8"

Bench lineare | Linear bench | Banc linéaire | Banco lineal

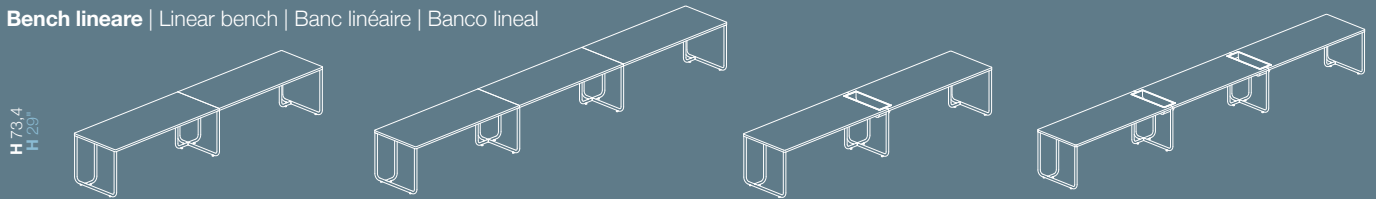

H 73.4
H 29"

L 240/280/320/360/400 - P 80/90 cm
W 94 1/2"-110 1/4"-126"-141 3/4"-157 1/2"
D 31 1/2"-35 1/2"

L 360/420/480/540/600 - P 80/90 cm
W 141 3/4"-149 5/8"-165 3/8"-189"-212 5/8"-236 1/4"
D 31 1/2"-35 1/2"

L 240/280/320/360/400 - P 80/90 cm
W 94 1/2"-110 1/4"-126"-141 3/4"-157 1/2"
D 31 1/2"-35 1/2"

L 360/420/480/540/600 - P 80/90 cm
W 141 3/4"-149 5/8"-165 3/8"-189"-212 5/8"-236 1/4" - D 31 1/2"-35 1/2"

Bench | Bench | Bench | Bench

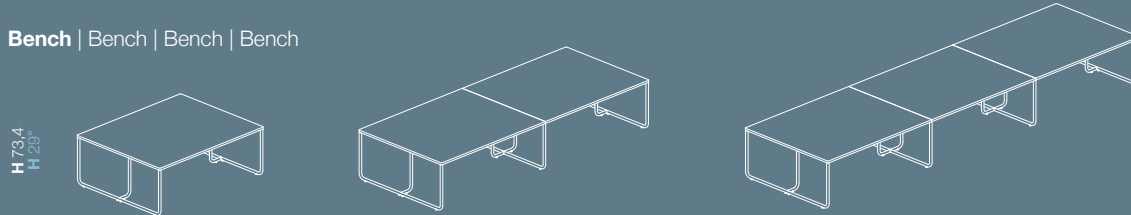

H 73.4
H 29"

L 120/140/160/180/200 - P 120/150/160 cm
W 47 1/4"-55 1/8"-63"-70 7/8"-78 3/4"
D 47 1/4"-59 1/8"-63"

L 240/280/320/360/400 - P 120/150/160 cm
W 94 1/2"-110 1/4"-126"-141 3/4"-157 1/2" - D 47 1/4"-59 1/8"-63"

L 360/420/480/540/600 - P 120/150/160 cm
W 141 3/4"-165 3/8"-189"-212 5/8"-236 1/4"
D 47 1/4"-59 1/8"-63"

Bench | Bench | Bench | Bench

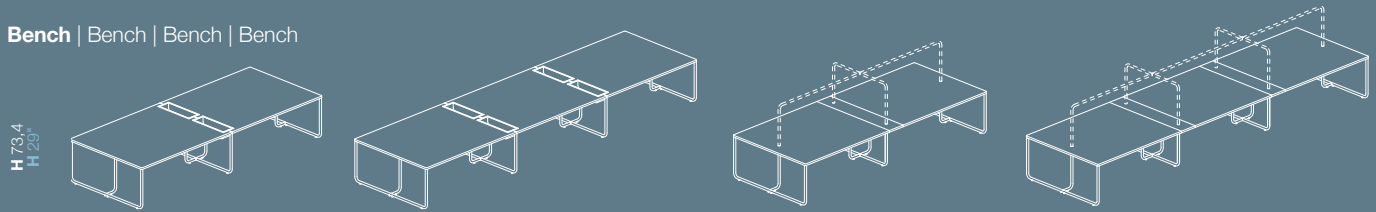

H 73.4
H 29"

L 240/280/320/360/400 - P 120/150/160 cm
W 94 1/2"-110 1/4"-126"-141 3/4"-157 1/2" - D 47 1/4"-59 1/8"-63"

L 360/420/480/540/600 - P 120/150/160 cm
W 141 3/4"-165 3/8"-189"-212 5/8"-236 1/4"
D 47 1/4"-59 1/8"-63"

L 240/280/320/360/400 - P 120/150/160 cm
W 94 1/2"-110 1/4"-126"-141 3/4"-157 1/2" - D 47 1/4"-59 1/8"-63"

L 360/420/480/540/600 - P 120/150/160 cm
W 141 3/4"-165 3/8"-189"-212 5/8"-236 1/4" - D 47 1/4"-59 1/8"-63"

Tavoli riunione | Meeting tables | Tables de réunion | Mesas de juntas



H 73.4
H 29"

Ø 100/120/150 cm
Ø 39 3/8"-47 1/4"-59 1/8"

L 210/240/280 - P 120 cm
W 82 3/4"-94 1/2"-110 1/4" - D 47 1/4"



1. Bench | Bench | Bench | Bench **Fin.** MK, XB, YB, DC
 L 180 P 160 cm | W 70 7/8" D 63"

2. Scrivania | Desk | Bureau | Mesa **Fin.** XV, YV
 L 200 P 90 cm | W 78 3/4" D 35 1/2"
Dattilo | Return | Retour | Ala
 L 120 P 60 cm | W 47 1/4" D 23 5/8"

3. Bench | Bench | Bench | Bench **Fin.** XV, YV, PET, FC, FF
 L 600 P 150 cm | W 236 1/4" D 59 1/8"

4. Bench | Bench | Bench | Bench **Fin.** MK, EK, FF
 L 400 P 160 cm | W 157 1/2" D 63"

5. Tavolo | Table | Table | Mesa **Fin.** MN, EB
 L 280 P 120 cm | W 110 1/4" D 35 3/8"

6. Bench | Bench | Bench | Bench **Fin.** MK, EK DC
 L 200 P 160 cm | W 78 3/4" D 63"
Bench | Bench | Bench | Bench
 L 400 P 160 cm | W 157 1/2" D 63"

7. Bench | Bench | Bench | Bench **Fin.** MN, EB, XE
 L 400 P 160 cm | W 157 1/2" D 63"

8. Bench | Bench | Bench | Bench **Fin.** XB, YB
 L 360 P 120 cm | W 141 3/4" D 47 1/4"

6.



7.

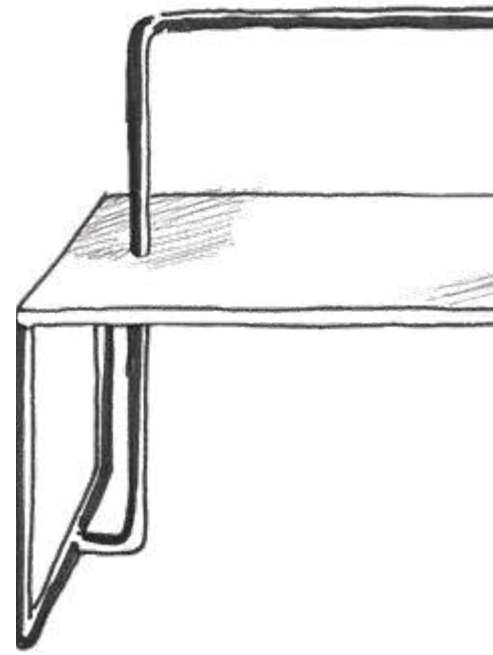



Rendez-Vous

Rendez-Vous è stato progettato per agevolare la condivisione dello spazio. In un'epoca dove la flessibilità in termini di modi e luoghi diventa un must, questa collezione si apre a molteplici interpretazioni.

I tavoli hanno piani da 18 mm e gambe tubolari in metallo verniciato. Partono da un'altezza di 73,4 cm, che si può aumentare arrivando a 90 o 105 cm. Questo incremento avviene grazie ad una struttura di base addizionale, provvista di poggiatesta, che si può colorare diversamente rispetto alle gambe e può essere aggiunta o rimossa a piacere.

Piano
Top
Plateau
Sobre



Struttura
Structure
Structure
Estructura



Screen
Screen
Écran
Panel



Rendez-Vous is designed to create collaboration spaces. In an age where flexibility in terms of ways and places is becoming a must, this collection is open to multiple interpretations.

Tables are composed by 18 mm (3/4") tops and tubular legs in painted metal. They start at a height of 73,4 cm (29"), which can be increased to 90 or 105 cm (35 3/8" or 41 3/8") thanks to an additional base frame with footrest, which can be painted in a different colour and can be added or removed as required.

Rendez-Vous est conçu pour créer des espaces de collaboration. À une époque où la flexibilité en termes de moyens et de lieux devient un must, cette collection est ouverte à de multiples interprétations.

Les tables sont composées de plateaux de 18 mm et de pieds tubulaires en métal peint. La première hauteur de la table est de 73,4 cm, qu'on peut augmenter jusqu'à 90 cm ou 105 cm. Ces dernières dimensions peuvent être atteints grâce à une structure additionnelle équipée de reposepieds, qui peut avoir une finition différente par rapport au pieds fixes. Ils pourront être ajoutés et enlevés à discrétion.

Rendez-Vous ha sido diseñado para facilitar el uso compartido del espacio. En una época en la que la flexibilidad en términos de modos y lugares se hace imprescindible, esta colección se abre a múltiples interpretaciones.

Las mesas tienen sobres de 18 mm y patas tubulares en metal pintado. Las mesas parten de una altura de 73,4 cm, que se puede aumentar alcanzando los 90 o 105 cm. Este aumento se produce gracias a una estructura básica adicional, equipada con reposapiés, que se puede colorar de un color diferente de las patas y se puede añadir o eliminar a voluntad.

light
flexible
stylish



Rendez-Vous. collection



Workstations
Workstations
Poste de travail
Estación de trabajo



Condivisione
Sharing
Partage
Compartir



Uffici privati
Private offices
Bureaux privés
Oficinas privadas



Sale riunioni
Meeting rooms
Salles de réunion
Salas de reuniones









1. **Tavolo** | Table | Table | Mesa **Fin.** MD, EI
 L 300 P 100 cm | W 118 1/8" D 39 3/8"
2. **Tavolo** | Table | Table | Mesa **Fin.** MD, YB
 L 160 P 80 cm | W 63" D 31 1/2"
 L 220 P 80 H 105 cm | W 86 5/8" D 31 1/2" H 41 3/8"
3. **Tavolo** | Table | Table | Mesa **Fin.** MT, ET, EO
 Ø 120 H 105 cm | Ø 47 1/4" H 41 3/8"
4. **Tavolo** | Table | Table | Mesa **Fin.** MI, EO, YC
 L 300 P 100 H 105 cm | W 118 1/8" D 39 3/8" H 41 3/8"
5. **Tavolo** | Table | Table | Mesa **Fin.** ML, EN
 L 220 P 100 | W 86 5/8" D 39 3/8"
6. **Bench** | Bench | Bench | Bench **Fin.** MI, DC, EO
 L 400 P 160 | W 157 1/2" D 63"
7. **Tavolo** | Table | Table | Mesa **Fin.** ML, EN
 L 240 P 140 | W 94 1/2" D 55 1/8"
8. **Tavolo** | Table | Table | Mesa **Fin.** MW, EZ, EN
 L 160 P 160 H 105 cm | W 63" D 63" H 41 3/8"





Piani | Desk tops | Plateaux | Sobres

Spessore 1,8 cm | 1,8 cm (3/4") thick | 1,8 cm d'épaisseur | 1,8 cm de espesor

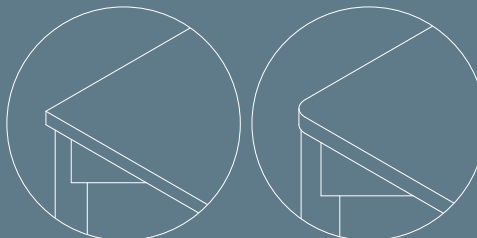

Struttura | Structure | Structure | Estructura

Sezione Ø 3,5 cm | Section Ø 3,5 cm (1 3/8") | Section Ø 3,5 cm | Sección Ø 3,5 cm

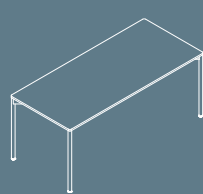

H 73,4 cm
H 29"

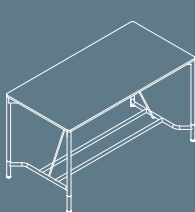

H 90 cm
H 35 3/8"

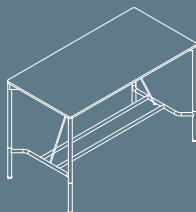

H 105 cm
H 41 3/8"



Ruote disponibili per H 73,4 e H 105 cm fino a L 200 cm

Castors available for H 73.4 (29") and H 105 cm (41 3/8") up to W 200 cm (78 3/4")

Roulettes disponibles pour H 73,4 et H 105 cm jusqu'à L 200 cm
Ruedas disponibles para H 73,4 y H 105 cm hasta L 200 cm

Scrivanie/tavoli | Desks/tables | Bureaux/tables | Mesas

H 73,4
H 29"



L 120/140/160 - P 80 cm
W 47 1/4"-55 1/8"-63" - D 31 1/2"

H 73,4/90/105 cm
H 29"-35 3/8"-41 3/8"

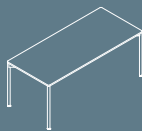

L 180/200/220/260/300 - P 80/100 cm
W 70 7/8"-78 3/4"-86 5/8"-102 3/8"-118 1/8" - D 31 1/2"-39 3/8"

Bench | Bench | Bench | Bench

H 73,4 cm
H 29"



L 120/140/160/180/200 - P 120/150/160 cm
W 47 1/4"-55 1/8"-63"-70 7/8"-78 3/4" - D 47 1/4"-59"-63"

H 90/105 cm
H 35 3/8"-41 3/8"

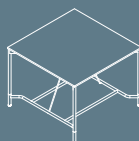

L 120/140/160/180/200/220/260/300 - P 120/150/160 cm
W 47 1/4"-55 1/8"-63"-70 7/8"-78 3/4"-86 5/8"-102 3/8"-118 1/8" - D 47 1/4"-59"-63"

Bench/tavoli multipli | Bench/multiple tables | Bench/tables multiples | Bench/múltiples mesas

H 73,4/90/105 cm
H 29"-35 3/8"-41 3/8"

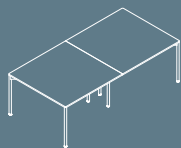

L 240/280/320/360/400 - P 80/100/120/150/160 cm
W 94 1/2"-110 1/4"-126"-141 3/4"-157 1/2" - D 31 1/2"-39 3/8"-47 1/4"-59"-63"

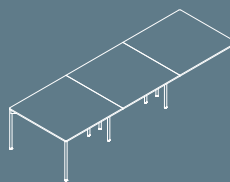

L 360/420/480/540/600 - P 80/100/120/150/160 cm
W 141 3/4"-165 3/8"-189"-212 5/8"-236 1/4" - D 31 1/2"-39 3/8"-47 1/4"-59"-63"

Tavoli riunione | Meeting tables | Tables de réunion | Mesas de juntas

H 73,4/90/105 cm
H 29"-35 3/8"-41 3/8"



Ø 120/150 cm
Ø 47 1/4"-59"



L 210 - P 120 cm / L 240 - P 140 cm
W 82 5/8" - D 47 1/4" - W 94 1/2" - D 55 1/8"





Zefiro

Zefiro è un classico che resiste nel tempo grazie alle sue elevate prestazioni tecniche quali: il telaio perimetrale in alluminio anodizzato con un rapido sistema di aggancio tra gambe e traversi, la particolare sezione della gamba e la tecnologia del magnete per fissare il piano alla struttura.

La collezione include anche la possibilità di attrezzare una parete con pannelli in tessuto puntaspilli, pensili con ante scorrevoli in metacrilato, mensole in vetro o contenitori a giorno.



Selezione Compasso d'Oro

Zefiro thanks to its high technical performance such as: the perimeter frame in anodized aluminium with a quick linking system between legs and crossbars, the special leg section and the magnet technology to secure the top to the structure.

The collection also includes the possibility of adding a supporting wall unit with fabric tackable panels, overheads with acrylic sliding doors, glass shelves or open storage solutions.

Zefiro résiste dans le temps grâce à ses hautes performances techniques telles que: le cadre périphérique en aluminium anodisé avec un système de fixation rapide entre les pieds et les traverses, la section particulière du pied et la technologie de l'aimant pour fixer le plateau sur le cadre de la structure.

La collection comprend également la possibilité d'équiper un panneau mural avec des écrans en tissu punaisable (acoustique), des éléments hauts avec portes coulissantes en méthacrylate, des tablettes en verre ou des rangements avec compartiments ouverts.

Zefiro es un clásico que resiste en el tiempo gracias a sus elevadas características técnicas como: el marco perimetral de aluminio anodizado con un rápido sistema de conexión entre patas y largueros, la particular sección de la pata y la tecnología del imán para fijar el sobre a la estructura.

La colección incluye también la posibilidad de equipar un tabique con paneles en tejido pinchable, contenedores colgantes con puertas corredizas en metacrilato, repisas en vidrio o contenedores colgantes abiertos.

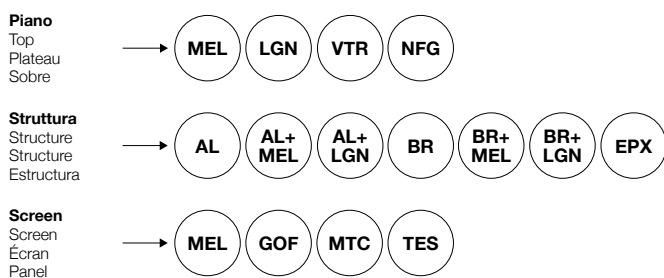

durable
 clever
 evergreen





Zefiro. collection



Condivisione
Sharing
Partage
Compartir



Uffici privati
Private offices
Bureaux privés
Oficinas privadas



Workstations
Workstations
Poste de travail
Estación de trabajo



Salae riunioni
Meeting rooms
Salles de réunion
Salas de reuniones

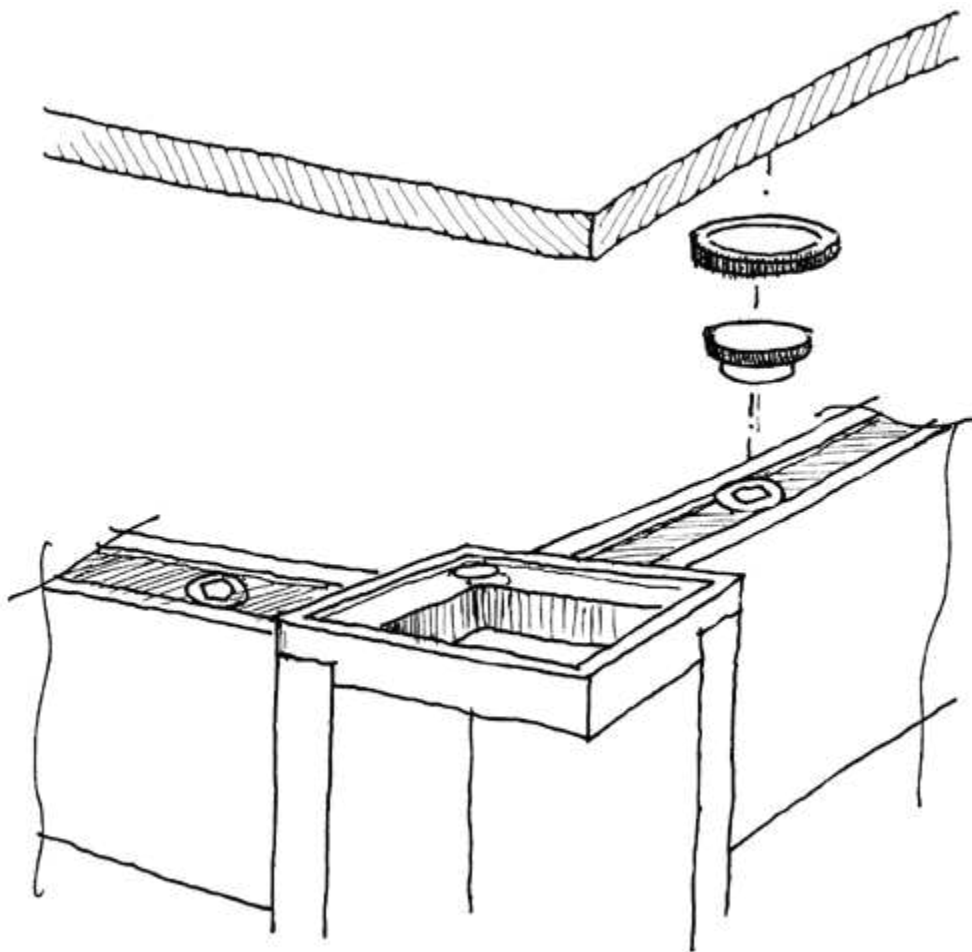



2.

Piani | Desk tops | Plateaux | Sobres



Spessore 1,2 cm
1,2 cm thick (1/2")
1,2 cm d'épaisseur
1,2 cm de espesor

Gambe | Legs | Pieds | Patas

Sezione 5,4x5,4 cm | Section 5,4x5,4 cm (2 1/8"x2 1/8") thick | Section 5,4x5,4 cm | Sección 5,4x5,4 cm

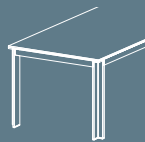

Sezione a L
L section
Section L
Sección en L

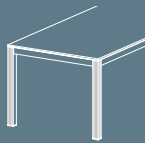

Sezione a L con inserto in melaminico o legno
L section with Italian melamine or wood insert
Section L avec insert en mélaminé ou bois
Sección en L con inserto de melamina o madera



Sezione quadrata
Square section
Section carrée
Sección cuadrada

Scrivanie | Desks | Bureaux | Mesas



L 110/130/150/170/190/210 - P 70/90 cm
W 43 1/4"-51 1/8"-59 -66 7/8"-74 3/4"-82 5/8" - D 27 1/2"-35 3/8"

Dattilo | Returns | Retours | Alas



L 60/80/100/120 - P 50 cm/L 80/100/120 - P 70 cm
W 23 5/8"-31 1/2"-39 3/8"-47 1/4" - D 19 3/4" - W 31 1/2"-39 3/8"-47 1/4" - D 27 5/8"

Tavoli riunione | Meeting tables | Tables de réunion | Mesas de juntas

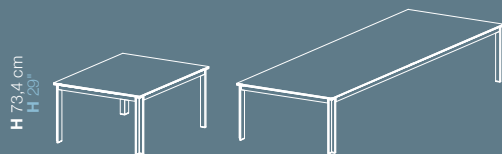

L/P 90/110 cm
W/D 35 3/8"-43 1/4"

L 230/270 - P 110 cm
W 90 1/2"-106 1/4" - D 43 1/4"

Mobili di servizio | Service units | Meuble retour | Muebles de servicio



L 141,5/180/190 - P 58 cm
W 55 1/8"-70 7/8"-74 3/4" - D 22 7/8"

L 161,5/200/210 - P 58 cm
W 63 5/8"-78 3/4"-82 5/8" - D 22 7/8"

Esempi composizioni | Composition example | Exemples de compositions | Ejemplos de composiciones

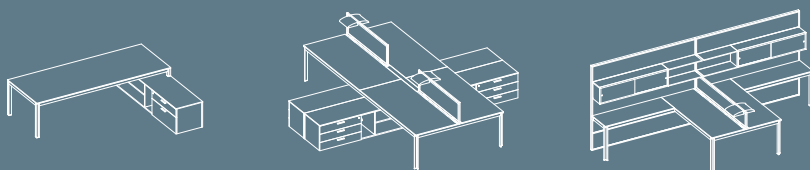

La collezione Zefiro include paretine a muro modulari, attrezzabili con mensole e corpetti

Zefiro collection includes modular wall units which can be equipped with shelves and overheads

La collection Zefiro comprend des panneaux muraux modulables, qui peuvent être équipés d'étagères et de modules-rangement

La colección Zefiro incluye paneles de pared modulares que se pueden equipar con repisas y contenedores colgantes



3.



1. Tavolo | Table | Table | Mesa **Fin.** MW, EZ
L 270 P 110 cm | W 106 1/4" D 43 1/4"

2. Tavolo | Table | Table | Mesa **Fin.** MW, EZ
L 110 P 110 H 100 cm | W 43 1/4" D 43 1/4" H 39 3/8"

3. Bench | Bench | Bench | Bench **Fin.** MI, EO
L 400 P 180 cm | W 157 1/2" D 70 7/8"



Blade

Blade ha un design fortemente distintivo, segnato da linee morbide e avvolgenti, esaltate da combinazioni di colore uniche e originali.

La peculiarità di questa collezione si esprime nella gamba in metallo tagliata a laser, che si caratterizza per la sua forma a lama: essenziale, forte ed elegante allo stesso tempo.

Le scrivanie danno un tocco originale e ricercato agli ambienti di lavoro.

Gli angoli dei piani sono preferibilmente arrotondati per creare un armonia con il design della gamba.

Blade has a distinctive design, marked by soft lines enhanced by unique and original colour combinations.

The peculiarity of this collection is expressed by the laser-cut metal leg, which appears like a blade: essential, strong and elegant at the same time.

Blade desks give an original and sophisticated touch to work environments.

The corners of the tops are preferably rounded to match the leg design.

Blade a un design distinctif, marqué par lignes douces, enveloppantes, agrémentées de combinaisons de couleurs uniques et originales.

La particularité de cette collection s'exprime dans le pied en métal coupé au laser, qui se caractérise par la forme de sa lame: essentielle, forte et en même temps élégante.

Les coins des plateaux de travail sont arrondis pour créer une harmonie avec le design du pied.

Les bureaux donnent une touche originale et raffinée aux environnements de travail.

Blade tiene un diseño muy distintivo, marcado por líneas suaves y envolventes, realizadas por combinaciones de color únicas y originales.

La peculiaridad de esta colección se expresa en la pata de metal cortada con láser, que se caracteriza por su forma de hoja: esencial, fuerte y elegante al mismo tiempo.

Los escritorios dan un toque original y refinado al lugar de trabajo.

Las esquinas de las partes superiores se redondean para coincidir con el diseño de la pata.

Piano
Top
Plateau
Sobre



Struttura
Structure
Structure
Estructura



Screen
Screen
Écran
Panel



charismatic
unique
contemporary



Blade. collection



Uffici privati
Private offices
Bureaux privés
Oficinas privadas



Contentori
Cabinets
Rangements
Contenedores



Bench
Bench
Bench
Bench



Salie riunioni
Meeting rooms
Salles de réunion
Salas de reuniones



Credenze
Credenzas
Buffets
Credenzas

p. 254 ←



Tavolini
Coffee tables
Tables basses
Mesitas











4.

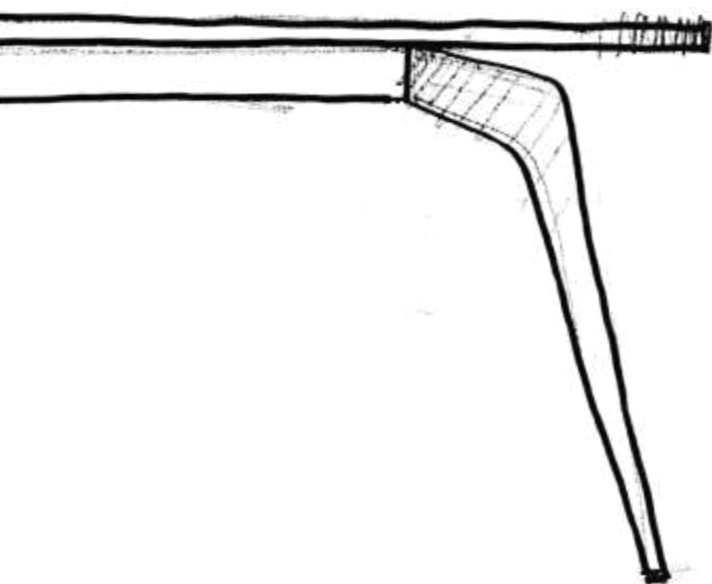

- 1. Bench** | Bench | Bench | Bench **Fin.** MF, EG
L 200 **P** 160 cm | **W** 78 3/4" **D** 63"
Mobile di servizio | Service unit | Meuble retour | Mueble de servicio
L 138 **P** 62 cm | **W** 54 3/8" **D** 24 3/8"
- 2. Scrivania** | Desk | Bureau | Mesa **Fin.** MN, EB, DF
L 180 **P** 90 cm | **W** 70 7/8" **D** 35 3/8"
- 3. Bench** | Bench | Bench | Bench **Fin.** MZ, EE
L 200 **P** 160 cm | **W** 78 3/4" **D** 63"
- 4. Composizione** | Composition | Composition | Composición
Fin. MN, EB **L** 400 **P** 350 cm | **W** 157 1/2" **D** 137 3/4"

Piani | Desk tops | Plateaux | Sobres

Spessore 3 cm | 3 cm (1 1/4") thick | 3 cm d'épaisseur | 3 cm de espesor



Con angoli raggiati
With rounded corners
Avec coins arrondis
Con esquinas redondeadas

Gambe | Legs | Pieds | Patas

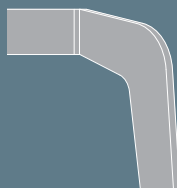

Spessore 1,2 cm
1,2 cm thick (1/2")
1,2 cm d'épaisseur
1,2 cm de espesor

Scrivanie | Desks | Bureaux | Mesas

Dattilo | Returns | Retours | Alas

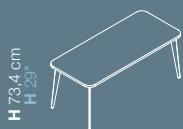

H 73,4 cm
H 29

L 120/140/160/180/200 - P 80 cm / L 180/200 - P 90 cm
W 47 1/4"-55 1/8"-63"-70 7/8"-78 3/4" - D 31 1/2" - W 70 7/8"-78 3/4" - D 35 3/8"

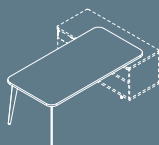

L 120/140/160/180/200 - P 80 cm
W 47 1/4"-55 1/8"-63"-70 7/8"-78 3/4" - D 31 1/2"

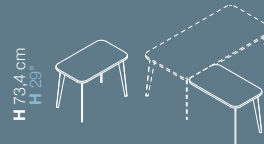

H 73,4 cm
H 29

L 80/100/120 - P 60 cm
W 31 1/2"-39 3/8"-47 1/4" - D 23 5/8"

Bench | Bench | Bench | Bench

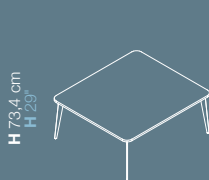

H 73,4 cm
H 29

L 120/140/160/180/200 - P 160 cm
W 47 1/4"-55 1/8"-63"-70 7/8"-78 3/4" - D 63"

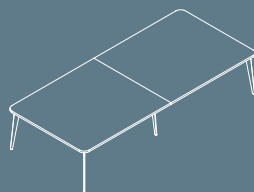
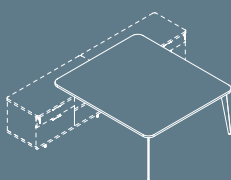

L 240/280/320/360/400 - P 160 cm
W 94 1/2"-110 1/4"-126"-141 3/4"-157 1/2" - D 63"

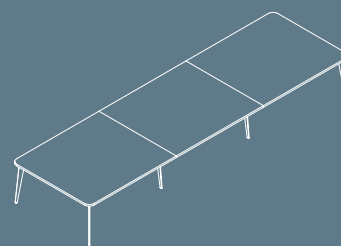

L 360/420/480/540/600 - P 160 cm
W 141 3/4"-165 3/8"-189"-212 5/8"-236 1/4" - D 63"

Tavoli riunione | Meeting tables | Tables de réunion | Mesas de juntas



H 73,4 cm
H 29

Ø 120/150 cm
Ø 47 1/4"-59"



L/P 120/160 cm
W/D 47 1/4"-63"



L 210/280 - P 120 cm
W 82 5/8"-110 1/4" - D 47 1/4"

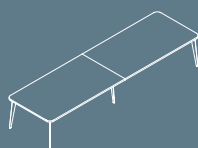

L 420/560 - P 120 cm
W 165 3/8"-220 1/2" - D 47 1/4"

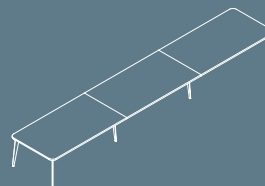

L 630 - P 120 cm
W 248" - D 47 1/4"

Tavolini da caffè | Coffee tables | Tables basses | Mesitas

Mobili di servizio | Service units | Meuble retour | Muebles de servicio



H 40 cm
H 15 3/4"

L/P 60 cm L 120 - P 60 cm
W/D 23 5/8" W 47 1/4" - D 23 5/8"



H 63 cm
H 24 3/4"

L 138,5 - P 62 cm
W 54 5/8" - D 24 3/8"

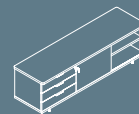

L 177/207 - P 62 cm
W 69 5/8"-81 1/2" - D 24 3/8"

Credenze | Credenzas | Buffets | Credenzas

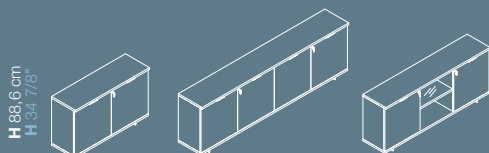

H 88,6 cm
H 34 7/8"

L 140/280,5 - P 45,5 cm
W 55 1/4"-110 1/2" - D 18"

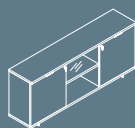

L 207 - P 45,5 cm
W 81 3/8" - D 18"

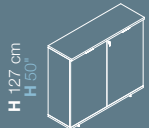

H 127 cm
H 50"

L 140/280 - P 45,5 cm
W 55 1/4"-110 3/8" - D 18"

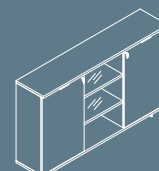
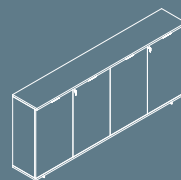

L 207 - P 45,5 cm
W 81 3/8" - D 18"

Crono

Crono è un sistema di scrivanie e postazioni multiple regolabili elettricamente in altezza. Il sistema è stato studiato e progettato per rispondere alla necessità di creare postazioni di lavoro ergonomiche, capaci di maggiore attenzione alla salute e al benessere dell'utente.

Il sistema Crono è disponibile con elevazione a 1 o 2 step oltre che nella versione "scrivania singola" o "postazione multipla".

L'elevazione è regolata da una pulsantiera che viene fissata sotto il piano, disponibile anche nella versione programmabile con possibilità di memorizzare fino a 4 posizioni in altezza.

Crono is an electrical height-adjustable system fitting freestanding desks and benches. The system has been designed to respond to the demand of ergonomic workstations oriented to the health and well-being of the user.

Crono system is available with 1 or 2 step elevation. Moreover it can come as a single freestanding desk or as a multiple workstation bench.

The elevation is controlled by a handswitch positioned underneath the top, also available in the programmable version with the possibility to store up to 4 positions in height.

Crono est un système de bureaux et de bench réglables en hauteur avec commande électronique. Le système a été étudié et conçu pour répondre à la nécessité de créer des postes de travail ergonomiques et de prêter plus d'attention à la santé et au bien-être de l'utilisateur.

Le système Crono est disponible en version 1 ou 2 niveaux ainsi qu'en version "bureau individuel" ou "bench".

L'élévation est contrôlée par un bouton-poussoir sous le plan de travail, également disponible dans la version programmable donnant la possibilité de mémoriser jusqu'à 4 hauteurs différentes.

Crono es un sistema eléctrico de altura ajustable que se adapta a escritorios y bancos independientes. El sistema ha sido diseñado para responder a la demanda de estaciones de trabajo ergonómicas orientadas a la salud y el bienestar del usuario.

El sistema Crono está disponible con elevación de 1 o 2 escalones, así como en la versión de "mesa única" o "estación de trabajo múltiple".

La elevación está controlada por un interruptor de mano ubicado debajo del sobre, también disponible en la versión programable con la posibilidad de almacenar hasta 4 posiciones de altura.

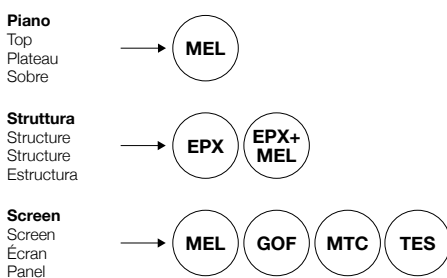

dynamic
versatile
adjustable





Crono. collection



Uffici privati
Private offices
Bureaux privés
Oficinas privadas



Bench
Bench
Bench
Bench





1.

1. Scrivania | Desk | Bureau | Mesa **Fin.** MZ, EZ
L 160 P 80 cm | W 63" D 31 1/2"

2. Composizione | Composition | Composition | Composición
Fin. MC, MN, EB L 510 P 170 cm | W 200 3/4" D 66 7/8"

3. Bench | Bench | Bench | Bench **Fin.** MZ, EZ
L 160 P 160 cm | W 63" D 63"

4. Composizione | Composition | Composition | Composición
Fin. ME, MN, EN L 290 P 190 cm | W 114 1/8" D 74 3/4"

5. Composizione | Composition | Composition | Composición
Fin. ME, MD, EI L 480 P 350 cm | W 189" D 137 3/4"







Pulsantiera | Handswitch | Tableau | Mando de control

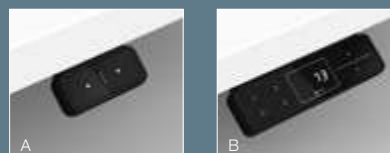

A) Pulsantiera semplice, B) Pulsantiera con 4 memorie
 A) Basic handswitch, B) Handswitch with 4 memories
 A) Tableau simple, B) Tableau avec 4 mémoires
 A) Mando de control simple, B) Mando de control con 4 memorias

Piede scrivania freestanding | freestanding desk foot | pied pour bureau individuel | pie para mesa individual

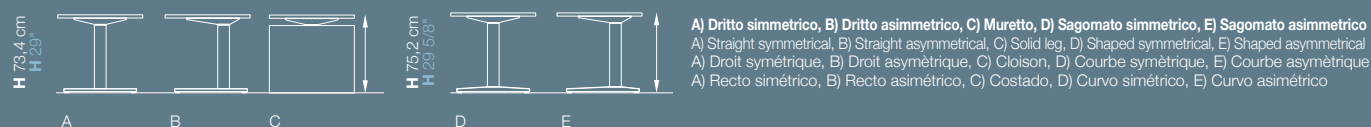

Piede bench | Bench foot | Pied pour bench | Pie para bench

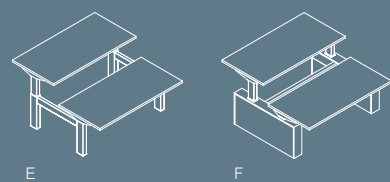

E) Struttura ad H, F) Struttura con muretto
 E) H shaped structure, F) Structure with solid leg,
 E) Structure en H, F) Structure avec colonne
 E) Estructura en forma de H, F) Estructura con costado

Scrivanie | Desks | Bureaux | Mesas



L 140/160/180/200 - P 80 cm/L 180/200 - P 90 cm
 W 55 1/8"-63"-70 7/8"-78 3/4"- D 31 1/2" - W 70 7/8"-78 3/4"- D 35 3/8"

Dattilo | Returns | Retours | Alas

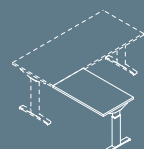

L 80/100/120 - P 60 cm
 W 31 1/2"-39 3/8"-47 1/4" - D 23 5/8"

Esempi composizioni | Composition example | Exemples de compositions | Ejemplos de composiciones

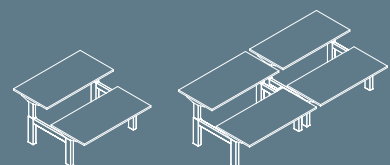

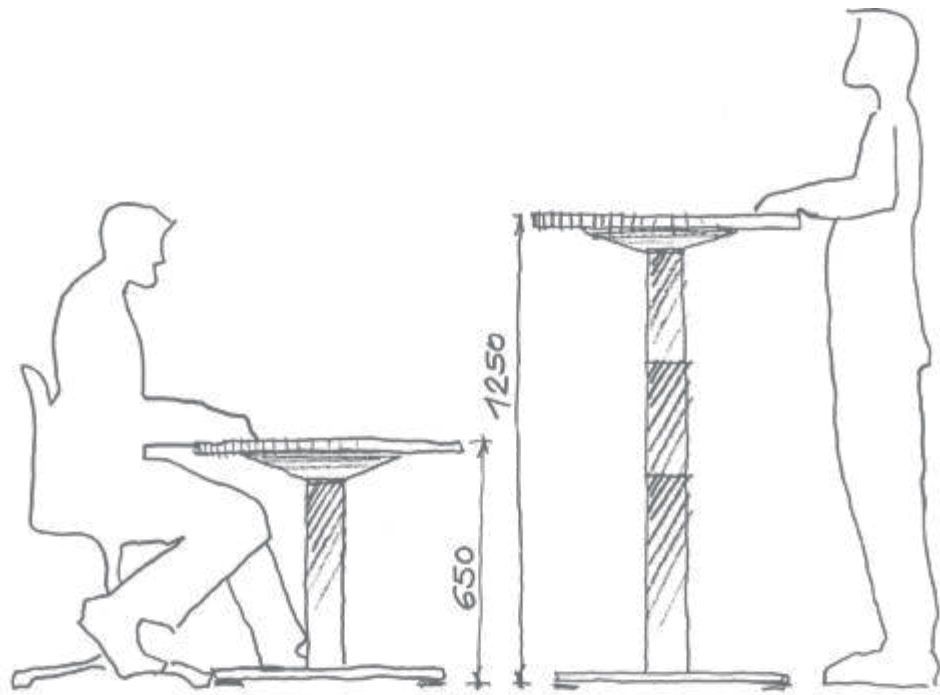



receptions

Receptions
Accueils
Recepciones

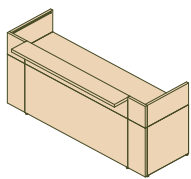

176
Philo

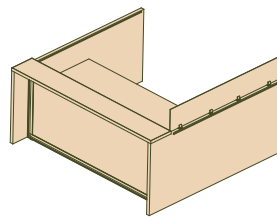

184
Eos



Philo

La reception Philo utilizza pannelli lignei di spessore 40 mm disponibili in diverse finiture melaminiche e in molte colorazioni laccate.

La pareti frontali e laterali sono divise in fasce verticali che permettono combinazioni di colore creative. I pannelli laterali sono dotati di profili dove agganciare accessori quali mensole, portacarte e portapenne.

Il top reception è disponibile in vetro retrolaccato con profilo in alluminio spazzolato lucido oppure in finitura legno. Può essere collocato in tre diverse posizioni: all'interno, a cavallo o all'esterno della parete frontale.

La reception Philo si abbina a tutte le collezioni Alea.

Philo reception uses 40 mm (1 5/8") thick wooden panels available in different Italian melamine finishes and in many lacquered colours.

Front and side walls are divided into vertical sections that allow creative colour combinations. The transaction top is available in back-lacquered glass with a polished brushed aluminium profile or in a wood finish.

The side panels come with profiles to attach accessories such as shelves, paper trays and pen holders.

The transaction top can be placed in three different positions: inside, in the middle or outside the front panel.

La banque d'accueil Philo utilise des panneaux en bois d'une épaisseur de 40 mm, disponibles dans différentes finitions mélaminés et dans de nombreuses couleurs laquées.

Les panneaux frontaux et latéraux sont divisés en bandes verticales qui permettent des combinaisons de couleurs. Le support accueil est disponible en verre rétro-laqué avec un profil en aluminium brossé poli ou en finition bois.

Les panneaux latéraux sont équipés de profils qui permettent de fixer des accessoires tels que des étagères, des porte-cartes et des porte-stylos. Le support accueil peut être positionné en trois positions différentes: à l'intérieur, en position médiane ou à l'extérieur du panneau frontal.

La recepción Philo utiliza paneles de melamina de 40 mm de espesor disponibles en diferentes acabados en melamina y en muchos colores lacados.

Los paneles frontales y laterales se dividen en bandas verticales que permiten combinaciones creativas de colores. La tapa superior está disponible en cristal lacado con perfil de aluminio cepillado, pulido o en acabado de melamina.

Los paneles laterales están equipados con perfiles donde se pueden colocar accesorios como repisas, portapapeles y portapapices. La tapa superior de la recepción se puede colocar en tres posiciones diferentes: en el interior, en el medio o por fuera del panel frontal.

Reception
Reception
Accueil
Recepción



crosswise
colourful
playful



Philo. collection



Area accoglienza
Welcome area
Aire d'accueil
Area de bienvenida

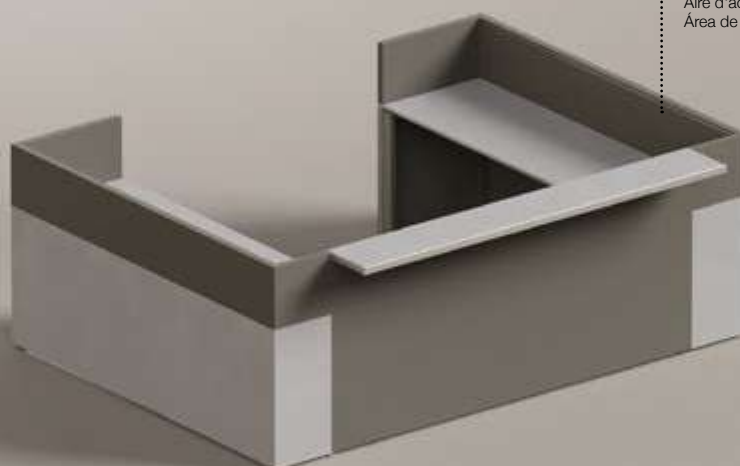

10





1. Composizione | Composition | Composition | Composición
Fin. MN, MD, GW, EB **L** 180 x **P** 110 cm | **W** 70 7/8" - **D** 43 1/4"

2. Composizione | Composition | Composition | Composición
Fin. MN, MZ, GW, EZ **L** 260 x **P** 110 cm | **W** 102 3/8" - **D** 43 1/4"

3. Composizione | Composition | Composition | Composición
Fin. MD, MN, MF **L** 200 x **P** 230 cm | **W** 78 3/4" - **D** 90 1/2"



Mensola | Top | Support | Estante



Senza profilo - melaminico
Without profile - Italian melamine
Sans profil - mélaminé
Sin perfil - melamina

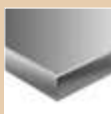

Con profilo - vetro
With profile - glass
Avec profil - verre
Con perfil - vidrio

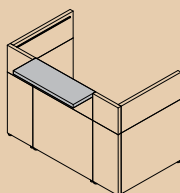

Montaggio a sbalzo
Outward
Montage en saillie
Instalación por fuera

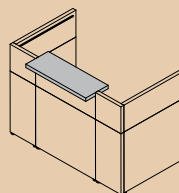

Montaggio in mezzaria
Mid position
Montage en position médiane
Instalación en el medio

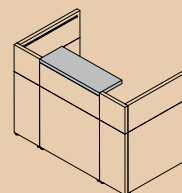

Montaggio a sbalzo
Outward
Montage en saillie
Instalación por fuera

Es. composizioni | Composition ex. | Ex. de compositions | Ej. de composiciones

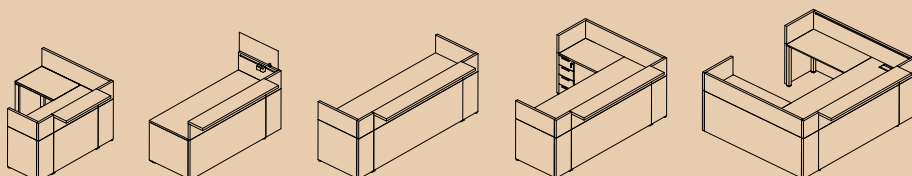



Eos

La collezione Eos è in grado di arredare la sala reception grazie all'utilizzo di pochi semplici elementi strutturali: due pannelli laterali, uno frontale (in melaminico, goffrato, tessuto o metacrilato) incorniciato da una struttura in alluminio e un top (lato visitatore) in vetro o legno con profilo in alluminio.

Gli elementi che compongono la reception sono modulari e facilmente adattabili. La struttura di Eos è autoportante e indipendente dal tavolo lavoro.

Eos collection is able to furnish the reception area thanks to few simple structural elements: two side panels, one frontal panel framed by an aluminium structure and one transaction top in glass or wood with an aluminium profile.

The reception components are modular and easily adaptable. Eos structure is freestanding. Any desk can be added within the structure.

La collection Eos est en mesure d'aménager la salle de réception grâce à l'utilisation de quelques éléments structurels simples: deux panneaux latéraux, un panneau frontal avec une structure en aluminium et l'autre en verre ou en bois avec profil en aluminium (côté visiteur).

Les éléments qui composent la banque d'accueil sont modulaires et facilement adaptables. La structure de Eos est autoportante et indépendante du bureau.

La colección Eos es capaz de amueblar la sala de espera gracias a la utilización de unos pocos elementos estructurales: dos paneles laterales, un panel frontal (en melamina, lacado, tejido o metacrilato) enmarcado por una estructura en aluminio y una tapa (lado del visitante) en cristal o melamina con un perfil de aluminio.

Los elementos que componen la recepción son modulares y fácilmente adaptables. La estructura de Eos es autoportante e independiente de la mesa de trabajo.

Reception
Reception
Accueil
Recepción



mix'n match
welcoming
refined





Eos. collection



Area accoglienza
Welcome area
Aire d'accueil
Área de bienvenida



1. Composizione | Composition | Composition | Composición
Fin. MN, MF, GY, EB **L** 210 x **P** 210 cm | **W** 82 5/8" - **D** 82 5/8"

2. Composizione | Composition | Composition | Composición
Fin. MN, GW, EB **L** 210 x **P** 100 cm | **W** 82 5/8" - **D** 39 3/8"



Mensola | Top | Support | Estante

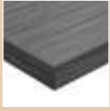

Senza profilo - melaminico
Without profile - Italian melamine
Sans profil - mélaminé
Sin perfil - melamina

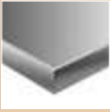

Con profilo - vetro
With profile - glass
Avec profil - verre
Con perfil - vidrio

Pannello frontale | Frontal panel | Panneau frontal | Panel frontal

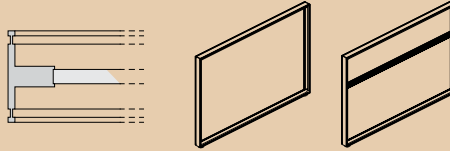

La parte frontale della reception è caratterizzata da un telaio in alluminio con sezione a "T" e pannelli in melaminico, gofrato, tessuto o metacrilato anche retrolaccato

The front of the reception desk features a T section aluminium frame with panels in different finishes: Italian melamine, embossed, fabric or acrylic (also backpainted)

La partie frontale de la réception est caractérisée par un châssis en aluminium avec section en "T" et panneaux disponibles en mélaminé, gaufré, tissu ou méthacrylate (également rétro-laqué)

La parte frontal del mueble de recepción está caracterizada por un marco de aluminio de sección en "T" y paneles disponibles en melamina, lacado, tejido o metacrilato (también lacado por detrás)

Es. composizioni | Composition ex. | Ex. de compositions | Ej. de composiciones

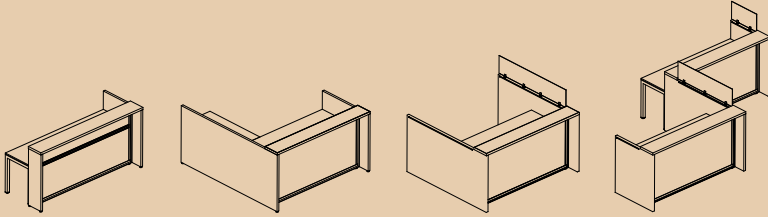



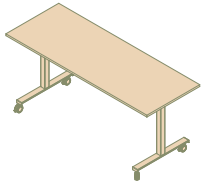

192
Club

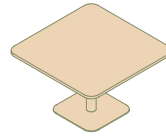

196
Tavoli
Tables
Tables
Mesas

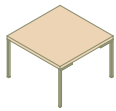

200
Ciro

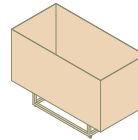

202
Jungla

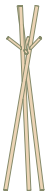

206
Bamboo



210
Ortho

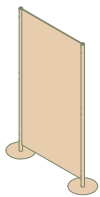

212
Stream

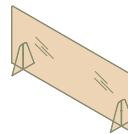

214
Safe



complementi

Complements
Compléments
Complementos



1.

Club

Il tavolo Club con piano ribaltabile e struttura su ruote, adatto ad arredare sale polifunzionali ed è dotato di un sistema di aggancio per collegare i tavoli tra loro.

Club is a folding table on casters with many applications, equipped with ganging device to connect tables side by side.

La table Club avec plateau rabattable et mobile, s'adapte à plusieurs configurations et solutions et convient aux salles polyvalentes. Il est équipé d'un système de fixation pour attacher les tables entre elles.

La mesa Club con el sobre plegable y la estructura sobre ruedas, es adecuada para salas polivalentes. Está equipado con un sistema de unión para vincular las mesas en línea.

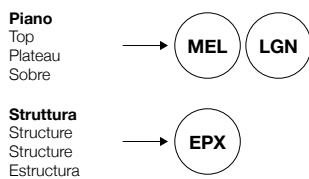

Condivisione
Sharing
Partage
Compartir

Scrivanie | Desks | Bureaux | Mesas

Es. composizioni | Composition ex. | Ex. de compositions | Ej. de composiciones



H 73,4 cm
H 29"

L 120/140/160/180 - P 60/70/80 cm
W 47 1/4"-55 1/8"-63"-70 7/8" - D 23 5/8"-27 1/2"-31 1/2"

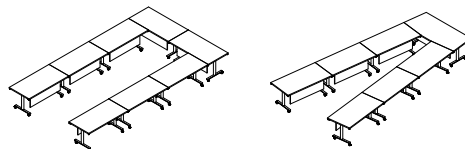

1. Scrivania | Desk | Bureau | Mesa **Fin.** MC, EN
L 140 x P 70 cm | W 55 1/8" - D 27 1/2"

2. Scrivania | Desk | Bureau | Mesa **Fin.** MC, ET
L 160 x P 80 cm | W 63" - D 31 1/2"



2.



Tavoli

Tables | Tables | Mesas

I tavoli con basamento in metallo, si adattano ad ogni tipo di ambiente. I basamenti sono sia quadrati che circolari, e si abbinano a piani di diverse forme: quadrata, rettangolare, rotonda, a botte.

Tables with metal base, match any type of environment. Bases can be both square and circular, combined with tops of different shapes: square, rectangular, round, barrel shaped.

Les tables à base métallique, s'adaptent à tout type d'environnement. Les bases sont à la fois carrées et rondes, combinées avec des plateaux de différentes formes: carré, rectangulaire, rond, tonneau.

Las mesas con base de metal, son adecuadas para cualquier tipo de ambiente. Las bases son tanto cuadradas como redondas, combinadas con sobres de diferentes formas: cuadradas, rectangulares, redondas, de barril.

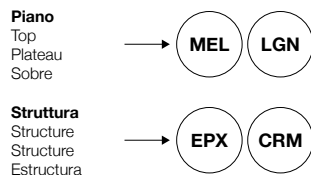

Sale riunioni
Meeting rooms
Salles de réunion
Salas de reuniones

Tavoli | Tables | Tables | Mesas

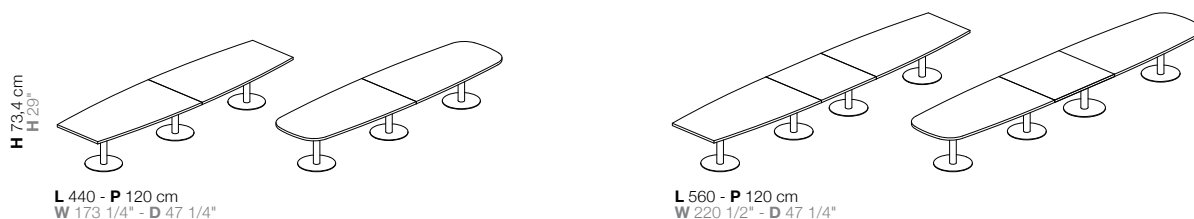
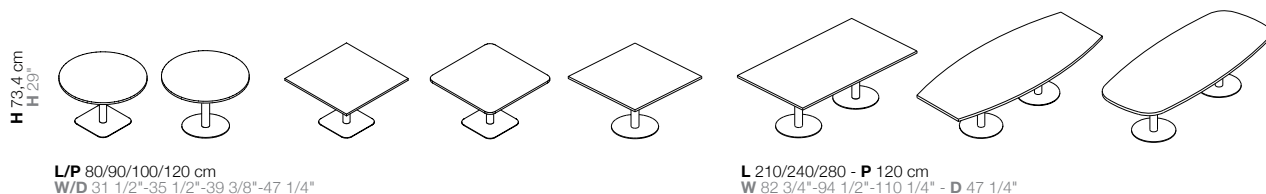



1.





1. Tavolo | Table | Table | Mesa **Fin.** ME, EN
L/P 120 cm | **W/D** 47 1/4"

2. Tavolo | Table | Table | Mesa **Fin.** MN, EB
Ø 120 cm | Ø 47 1/4"

3. Tavolo | Table | Table | Mesa **Fin.** MM, EO
L 210 P 120 cm | **W** 82 5/8" **D** 47 1/4"

TO

I grew up in a farming family. I hated cleaning out the chickens but loved hatching them and feeding the new born sheep. The smell of hot milk still has a special resonance for me. Harvest was back-breaking work though... Where do you think Jesus got his brains from?

Joseph Beale



1.

Ciro

I tavolini da caffè Ciro si possono abbinare facilmente a diverse tipologie di arredo. Le gambe in metallo con forma a L e sezione quadrata rendono il design di questo complemento particolarmente leggero.

Ciro coffee tables are meant to be easily paired with different furnishing typology. The metal legs with L shape and square section make this item's design particularly light.

Les tables basses Ciro, peuvent être facilement combinées avec différents types de meubles. Les pieds métalliques en forme de L et de section carrée rendent le design de ce complément particulièrement léger.

Las mesitas Ciro, pueden ser fácilmente combinadas con diferentes tipos de muebles. Las patas metálicas con forma de L y sección cuadrada hacen que el diseño de este complemento sea particularmente ligero.

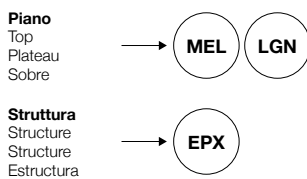

Tavolini
Coffee tables
Tables basses
Mesitas

1. Tavolino da caffè | coffee table | table basse | mesita
Fin. NO, EN L/P 60 cm | W/D 23 5/8"

Tavolini da caffè | Coffee tables | Tables basses | Mesitas

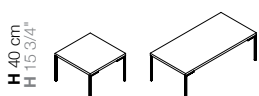

H 40 cm
H 15 3/4"

L 60/120 - P 60 cm
W 23 5/8"-47 1/4" - D 23 5/8"

Jungla

Jungla è il porta piante completamente realizzato in metallo, disponibile in vari colori epossidici. Si tratta di un sistema di vasi sorretti da un basamento che li eleva dal pavimento, arrivando a creare dei veri e propri divisori verdi. Viene proposto nelle versioni con uno o tre vasi.

Jungla is the planter completely made of metal, available in various epoxy colours. It is a system of pots supported by a base that elevates them from the floor, creating true green dividers. It is available in versions with one or three pots.

Jungla est le porte-plante entièrement en métal, disponible en différentes couleurs époxy. C'est un système de vases soutenus par une base qui les surélève du sol, créant de véritables cloisons vertes. Il est proposé en versions à un ou trois pots.

Jungla es la jardinera completamente de metal, disponible en varios colores epoxi. Se trata de un sistema de macetas apoyadas en una base que las eleva del suelo, creando verdaderos separadores verdes. Está disponible en versiones con una o tres macetas.

Struttura
Structure
Structure
Estructura



Porta piante | Planters | Porte-plante | Jardineras

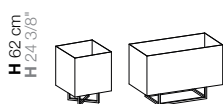

L 45/90 - P 45 cm
W 17 3/4"-35 3/8" - D 17 3/4"

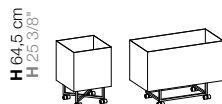

L 45/90 - P 45 cm
W 17 3/4"-35 3/8" - D 17 3/4"

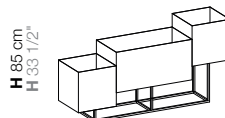

L 180 - P 45 cm
W 70 7/8" - D 17 3/4"

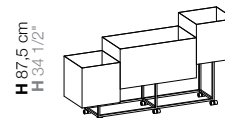

L 180 - P 45 cm
W 70 7/8" - D 17 3/4"



1.



2.

1. Porta piante | Planters | Porte-plante | Jardineras **Fin. EE**
L 90 cm | W 35 3/8"

2. Porta piante | Planters | Porte-plante | Jardineras **Fin. YC**
L 180 cm | W 70 7/8"

3. Porta piante | Planters | Porte-plante | Jardineras **Fin. EG**
L 45 cm | W 17 3/4"



3.

BEVERLY HILLS
WEDON FASHION
CHANEL THE VOCABULARY OF STYLE
ITALIAN
THE SCHOOL OF FASHION
DRESSING FOR THE DARK



1.

Bamboo

Bamboo è l'appendiabiti freestanding semplice e contemporaneo. Bamboo è composto da tubolari in metallo disposti a intreccio e verniciati a polveri epossidiche, disponibili in tutti i colori della palette Alea. I pochi elementi che lo compongono creano svariati punti di appiglio per giacche e cappotti. L'altezza complessiva è di 170 cm.

Bamboo is the simple and contemporary freestanding coat rack. Bamboo is made up of metal tubes arranged in an interlocking pattern and painted with epoxy powders, available in the whole Alea colour palette. The few elements that compose it create a variety of holding points for jackets and coats. Its total height is 170 cm (66 7/8").

Bamboo est un porte-manteau autoportant simple et contemporain. Bamboo est constitué de tubes métalliques entrelacés et peints avec des poudres époxy, disponibles dans toutes les couleurs de la palette Alea. Les quelques éléments qui le composent créent une variété de points de maintien pour les vestes et les manteaux. La hauteur totale est de 170 cm.

Bamboo es el perchero independiente sencillo y contemporáneo. Bamboo se compone de tubos metálicos entrelazados y pintados con polvos epoxídicos, disponibles en todos los colores de la paleta Alea. Los pocos elementos que la componen crean una variedad de puntos de sujeción para chaquetas y abrigos. La altura total es de 170 cm.

Struttura
Structure
Structure
Estructura

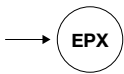

Appendiabiti | Coat rack | Porte-manteau | Perchero



L 43 - P 43 cm
W 16 7/8" - D 16 7/8"



2.

1. Appendiabiti | Coat rack | Porte-manteau | Perchero **Fin. EO**

2. Appendiabiti | Coat rack | Porte-manteau | Perchero **Fin. EI**

3. Appendiabiti | Coat rack | Porte-manteau | Perchero **Fin. YC**



3.

Ortho

.paretina

Le paretine Ortho sono pensate per essere agganciate alle scrivanie, ottenendo così un angolo di privacy in modo facile e veloce. La paretina è composta da un pannello in melaminico di spessore 30 mm e con angoli raggianti, disponibile anche con rivestimento tessuto, e da un piede in metallo verniciato epossidico che la sostiene.

Ortho wall panels are designed to be attached to desks, thus obtaining a corner of privacy quickly and easily. The panel is composed of a 30 mm (1 1/4") thick melamine panel with rounded corners, also available with fabric cover, and an epoxy painted metal foot that supports it.

Les cloisons Ortho sont conçues pour être fixées aux bureaux, ce qui permet d'obtenir un coin d'intimité rapidement et facilement. Elle est composée d'un panneau en mélamine de 30 mm d'épaisseur avec coins arrondis, également disponible revêtue en tissu et par un pied en métal époxy.

Los biombos divisorios de Ortho están diseñados para ser fijados a los escritorios, obteniendo así un rincón de privacidad de forma rápida y fácil. El panel está compuesto por un panel de melamina de 30 mm de grosor con esquinas redondeadas, también disponible con cubierta de tela, y un pie metálico pintado con epoxi que lo sostiene.

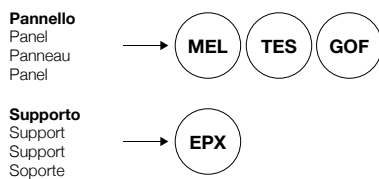

1. Paretina | Wall panel | Cloison | Biombo **Fin. DC, ET**
L 80 cm | W 31 1/2"



Divisori
Dividers
Séparateurs
Separadores

Paretina | Wall panel | Cloison | Biombo



L 60/70/80/90/100 - P 3 cm
W 23 5/8"-27 1/2"-31 1/2"-35 3/8"-39 3/8" - D 1 1/4"



1.



1.

Stream

Stream è un sistema indipendente composto da un pannello supportato da una coppia di tubolari metallici con basamenti. I pannelli sono disponibili in diversi materiali e finiture per adattarsi a qualsiasi tipo di stile e utilizzo. Possono inoltre essere agganciati in diverse posizioni per creare un layout dinamico.

Stream is a freestanding panel system supported by a pair of metal poles with a round base. Panels are available in different materials and finishes to adapt to any type of use and style. Panels can be hung in several positions in order to create a dynamic layout.

Stream est un système de panneaux autoportants soutenu par une paire de poteaux métalliques avec des bases rondes. Les panneaux sont disponibles en différents matériaux et finitions pour s'adapter à tout type d'utilisation et de style. Les panneaux peuvent être suspendus dans plusieurs positions afin de créer une disposition dynamique.

Stream es un sistema de panel independiente soportado por un par de tubulares metálicos con bases redondas. Los paneles están disponibles en diferentes materiales y acabados para adaptarse a cualquier tipo de uso y estilo. Los paneles se pueden ser enganchados en varias posiciones para crear un diseño dinámico.

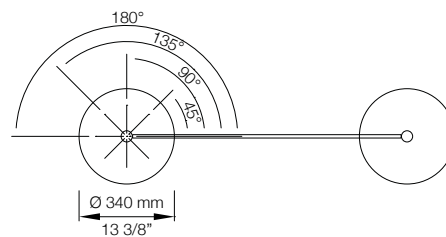
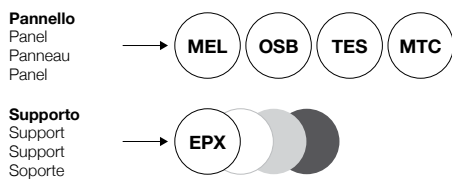

Divisori
Dividers
Séparateurs
Separadores

1. Paretina | Wall panel | Cloison | Biombo **Fin.** BN, EB
H 178 cm | **H** 70"

Paretina | Wall panel | Cloison | Biombo

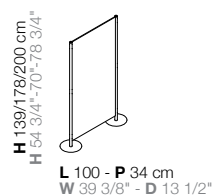

Safe

Safe è la linea di prodotti che trasforma l'ambiente in un luogo sicuro e sano. Gli screen Safe sono progettati per proteggere le persone da virus e batteri. Rispondono alle regolamentazioni attualmente in vigore e sono molto facili da pulire e installare.

Safe, is the product line that transforms the environment into a safe and healthy place. Safe screens are designed to protect people from viruses and bacteria. They comply with current regulations and are very easy to clean and install.

Safe, est la ligne de produits qui transforme l'environnement de travail dans un lieu sûr et sain. Les écrans Safe sont conçus pour protéger les gens contre les virus et bactéries. Ils sont conformes à la réglementation en vigueur et sont très simple à nettoyer et à installer.

Safe, es la línea de productos que transforma el medio ambiente en un lugar seguro y saludable. Las pantallas Safe están diseñadas para protegerlo de virus y bacterias. Cumplen a las regulaciones globales y son fáciles de limpiar e instalar.

Pannello
Panel
Panneau
Panel



Supporto
Support
Support
Soporte



Divisori
Dividers
Séparateurs
Separadores

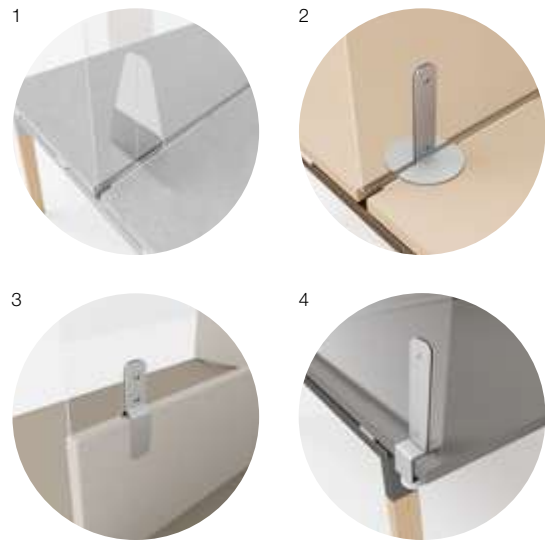

1) Base in metacrilato, 2) Base in metallo, 3) Staffa in metallo, 4) Morsetto in metallo
1) Methacrylate base, 2) Metal base, 3) Metal bracket, 4) Metal clamp
1) Base en méthacrylate, 2) Base métallique, 3) Support métallique, 4) Pince métallique
1) Base de metacrilato, 2) Base metálica, 3) Soporte metálico, 4) Abrazadera metálica

Paretina | Wall panel | Cloison | Biombo

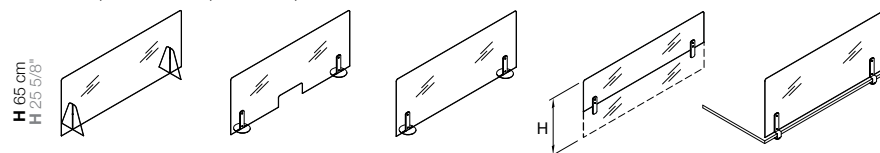

L 60/80/90/100/120/140/160/180/200 cm
W 23 5/8"-31 1/2"-35 3/8"-39 3/8"-47 1/4"-55 1/8"-63"-70 7/8"-78 3/4"





librerie

Bookcases
Bibliothèques
Libreros

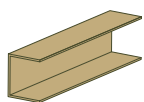

218
Icaro

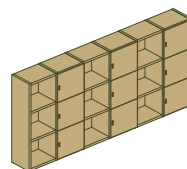

220
Titano

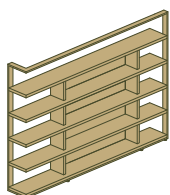

224
Archimede

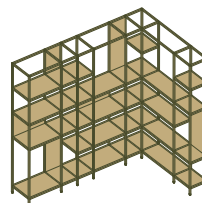

228
Q18



1.

Icaro

Le mensole modulari Icaro sono realizzate in lamiera di acciaio piegata e verniciata a polveri epossidiche. Vengono fissate al muro tramite supporti a scomparsa e possono essere dotate di fermalibri verticali in metallo che si possano spostare lungo la mensola.

Icaro modular shelves are made of folded steel sheet epoxy painted. They are fixed to the wall by means of concealed brackets and can be equipped with vertical metal bookends that can be moved along the shelf.

Les étagères modulaires Icaro sont réalisées en tôle d'acier pliée, vernis à poudre époxy et se fixent au mur parmi de supports invisibles. Il est possible d'intégrer les étagères avec de ferme-livres mobiles en métal qui peuvent être déplacés à discrétion le long de l'étagère.

Las estanterías modulares Icaro están realizadas en chapa de acero plegada y pintada con pintura epoxi. Se fijan a la pared mediante soportes retráctiles y se pueden equipar con separadores verticales metálicos para libros que se pueden desplazar a lo largo de la estantería.

Mensola
Shelves
Étagères
Librero



Librerie
Bookcases
Bibliothèques
Libreros

1. Mensola | Shelf | Étagère | Estantería **Fin. EO**
L 150 cm | W 59"

Mensola | Shelf | Étagère | Estantería

H 36,7 cm
H 14 1/2"

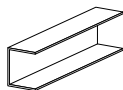

L 50/100/150/200 - P 27,5 cm
W 19 3/4"-39 3/8"-59"-78 3/4" - D 10 7/8"

Titano

Le librerie modulari Titano prevedono un'articolata componibilità sia verticale che orizzontale. Ai vani a giorno è possibile applicare delle ante quadrate con maniglia incassata oppure dei contenitori classificatori.

Titano modular bookshelf provides a wide range of vertical and horizontal solutions. Square doors or filing cabinets with recessed handles can be integrated to the bookshelf.

Les bibliothèques modulaires Titano offrent une modularité articulée soit verticalement que horizontalement. Pour les compartiments ouverts, il est possible d'appliquer des portes carrées avec des poignées intégrées ou des bloc de 2 tiroirs pour dossiers suspendus.

Los libreros modulares Titano presentan una modularidad articulada tanto vertical como horizontal. En los módulos abiertos se pueden aplicar las siguientes puertas cuadradas con tirador embutido o contenedores archivadores.

Struttura
Structure
Structure
Estructura



Anta
Door
Porte
Puerta



Librerie
Bookcases
Bibliothèques
Libreros

Moduli | Modules | Modules | Módulos

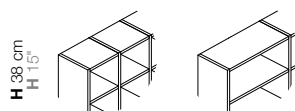

H 38 cm
H 15"

L 38/79 - P 39,4 cm
W 15"-31 1/8" - D 15 1/2"

Dimensioni vano utile
Internal dimensions
Dimensions utiles du module
Dimensiones útiles del módulo

Esempi librerie | Example bookshelves | Exemples bibliothèque | Ejemplos libreros

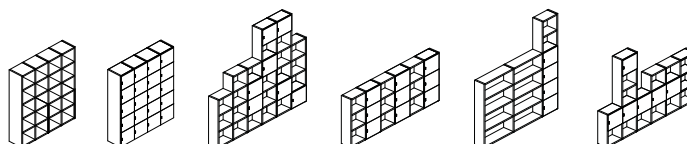



1.



2.



3.



1. Libreria | Bookshelf | Bibliothèque | Librero **Fin.** MZ, MI

2. Libreria | Bookshelf | Bibliothèque | Librero **Fin.** MN, ML
L 330 **P** 39 **H** 210 cm | **W** 129 7/8" **D** 15 3/8" **H** 82 5/8"

3. Libreria | Bookshelf | Bibliothèque | Librero **Fin.** MN, ME
L 495 **P** 43 **H** 127 cm | **W** 194 7/8" **D** 16 7/8" **H** 50"

4. Libreria | Bookshelf | Bibliothèque | Librero **Fin.** MN, MD
L 250 cm **P** 43 **H** 127 cm | **W** 98 3/8" **D** 16 7/8" **H** 50"



1.

Archimede

La libreria Archimede si contraddistingue per il suo design lineare composto da una struttura in metallo che va a incorniciare le mensole. Disponibile anche nella versione con vano TV.

The Archimede bookcase stands out for its linear design composed of a metal structure that frames the shelves. Also available with a TV compartment.

La bibliothèque Archimede se distingue par son design linéaire composé d'une structure en métal qui encadre les étagères. En outre disponible dans la version avec compartiment de télévision.

El librero Archimede se distingue por su diseño lineal compuesto por una estructura metálica que enmarca las repisas. También disponible en la versión con compartimento para TV.

Struttura
Structure
Structure
Estructura

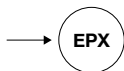

Mensole
Shelves
Étagères
Libreros



Librerie
Bookcases
Bibliothèques
Libreros

Librerie | Bookshelves | Bibliothèque | Libreros

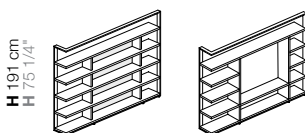

H 101 cm
H 75 1/4"

L 272 - P 36 cm
W 107 1/8" - D 14 1/8"

1. **Libreria** | Bookshelf | Bibliothèque | Librero **Fin.** MM, MJ, EI
2. **Libreria** | Bookshelf | Bibliothèque | Librero **Fin.** MF, MC, EK

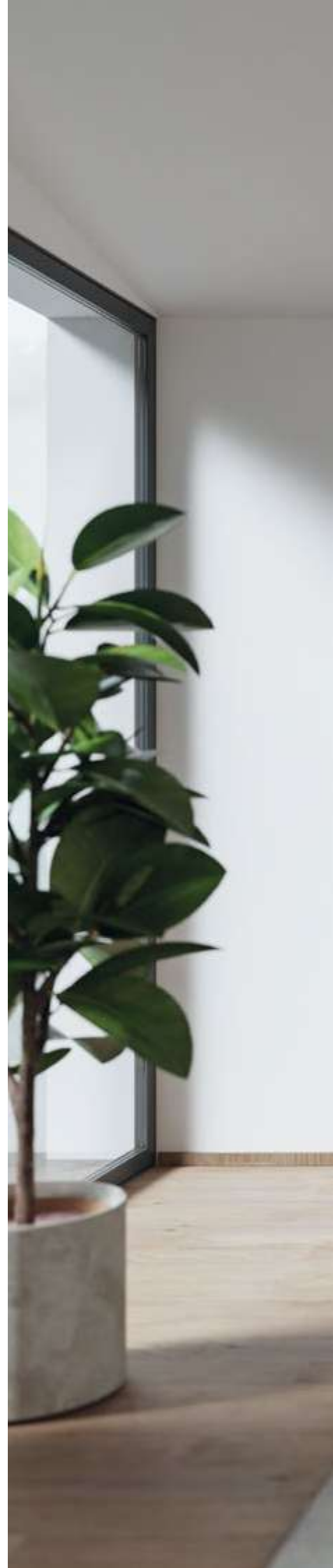



Q18

Il design unico del sistema di librerie Q18 è l'equilibrio perfetto tra complanarità dei componenti, libertà di layout e molteplici opzioni di colore. Q18 è una soluzione modulare composta da una struttura in tubolare di alluminio con sezione 18x18 mm, alla quale vengono integrati pannelli e moduli contenitori. Il sistema di fissaggio intelligente che unisce le parti in alluminio rende questo prodotto elegante e pulito, senza viti a vista.

The unique design of the Q18 shelving system is the perfect balance between flushness of components, layout freedom and multiple colour options. Q18 is a modular solution consisting of a tubular aluminium structure with 18x18 mm (3/4"x3/4") section, to which panels and container modules are integrated. The intelligent fixing system that combines the aluminium parts makes this product elegant and clean, without visible screws.

Le design unique du système d'étagères Q18 est l'équilibre parfait entre la fluidité des composants, la liberté d'agencement et les multiples options de couleurs. Q18 est une solution modulaire constituée d'une structure tubulaire en aluminium de section 18x18 mm, à laquelle sont intégrés des panneaux et des modules de conteneurs. Le système de fixation intelligent qui combine les pièces en aluminium rend ce produit élégant et propre, sans vis apparentes.

El diseño único de la estantería Q18 es el equilibrio perfecto entre la coplanaridad de los componentes, la libertad de distribución y las múltiples opciones de color. Q18 es una solución modular que consiste en una estructura tubular de aluminio de sección 18x18 mm, a la que se integran paneles y módulos de contenedores. El sistema de fijación inteligente que combina las piezas de aluminio hace que este producto sea elegante y limpio, sin tornillos visibles.

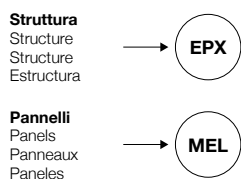

Librerie
Bookcases
Bibliothèques
Libreros



Workstations
Workstations
Poste de travail
Estación de trabajo



Condivisione
Sharing
Partage
Compartir



Tavolini
Coffee tables
Tables basses
Mesitas

Es. composizioni | Composition ex. | Ex. de compositions | Ej. de composiciones

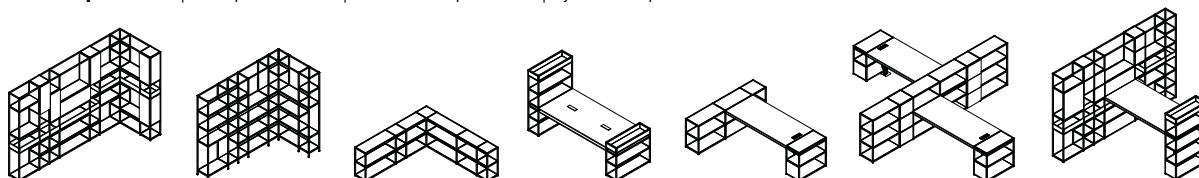



1.



2.



3.

1. Libreria | Bookshelf | Bibliothèque | Librero **Fin.** MK, EI, HB
L 262 **P** 46 **H** 215 cm | **W** 103 1/8" **D** 18 1/8" **H** 84 5/8"

2. Libreria | Bookshelf | Bibliothèque | Librero **Fin.** MK, MJ, MT, EN
L 292 **P** 46 **H** 180 cm | **W** 115" **D** 18 1/8" **H** 70 7/8"

3. Libreria | Bookshelf | Bibliothèque | Librero **Fin.** MT, ET
L 162 **P** 33 **H** 77 cm | **W** 63 3/4" **D** 13" **H** 30 1/4"
Tavolini | Coffee tables | Tables basses | Mesitas
L 60 **P** 60 **H** 41 cm | **W** 23 5/8" **D** 23 5/8" **H** 16 1/8"

4. Libreria | Bookshelf | Bibliothèque | Librero **Fin.** MC, ML, EN, HB
L 400 **P** 46 **H** 215 cm | **W** 157 1/2" **D** 18 1/8" **H** 84 5/8"

5. Libreria | Bookshelf | Bibliothèque | Librero **Fin.** MK, MJ, EN
L 232 **P** 33 **H** 300 cm | **W** 91 3/8" **D** 13" **H** 118 1/8"



4.



5.



234

Cassettiere

Pedestals
Blocs tiroirs
Cajoneras



238

Remo

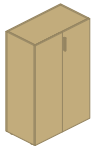

242

**Ottanta/
Novanta**

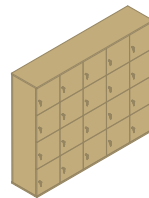

246

Lato

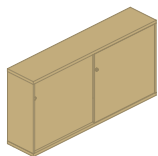

250

Romolo

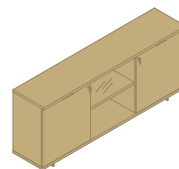

254

Blade X

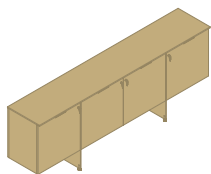

258

Oasi

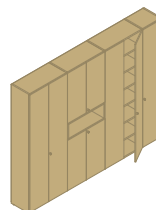

262

Quattro



1.

Cassettiere

Pedestals | Blocs tiroirs | Cajoneras

Le cassettiere su ruote si adattano a ogni collezione Alea e possono avere maniglie o presa laterale. Sono inoltre disponibili mobili di servizio con cassetti, vani a giorno o ante, sorretti da ruote.

Pedestals on wheels are complementary to every Alea collection and may have handles or side grip. Service units on wheels with drawers, open compartments or doors are also available.

Les blocs tiroirs sur roulettes s'adaptent à toutes les collections Alea et peuvent être dotés des poignées ou disposer d'une prise latérale. Des meubles de service avec tiroirs, compartiments ouverts ou portes sont également disponibles, supportées par des roulettes.

Las cajoneras con ruedas son adaptables a todas las colecciones Alea y pueden tener tiradores o empuñaduras laterales. También están disponibles muebles de servicio con cajones, compartimentos abiertos o puertas, soportados por ruedas.

Cassettiere
Pedestals
Blocs tiroirs
Cajoneras



Contentori
Cabinets
Rangements
Contenedores

Cassettiere | Pedestals | Blocs tiroirs | Cajoneras

Legno | Wood
Bois | Madera

H 56 cm
H 21 3/4"



L 33/45 - P 58 cm
W 13"-17 3/4" - D 22 7/8"

H 64,5 cm
H 25 1/2"



L 44 - P 58 cm
W 17 3/8" - D 22 7/8"

Metallo | Metal
Metal | Metal

H 56 cm
H 21 3/4"



L 42 - P 53/56 cm
W 16 5/8" - D 20 7/8"-22 1/8"

H 50,5 cm
H 20"



L 32 - P 53 cm
W 12 5/8" - D 20 7/8"

Mobili di servizio | Service units | Meubles de service | Muebles de servicio

Legno | Wood
Bois | Madera

H 64,5 cm
H 25 1/2"

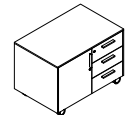

L 89 - P 58 cm
W 35 1/8" - D 22 7/8"

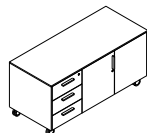

L 134 - P 58 cm
W 52 7/8" - D 22 7/8"

H 64 cm
H 25 1/4"

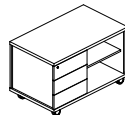

L 100 - P 60 cm
W 39 3/8" - D 23 5/8"

H 56 cm
H 22 1/8"

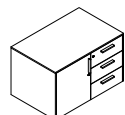

L 89 - P 58 cm
W 35 1/8" - D 22 7/8"



2.



1. Cassettiere | Pedestals | Blocs tiroirs | Cajoneras
Fin. MD **L** 33 **P** 58 **H** 55 cm | **W** 13" **D** 22 7/8" **H** 21 5/8"

2. Cassettiere | Pedestals | Blocs tiroirs | Cajoneras
Fin. EB **L** 42 **P** 53 **H** 55 cm | **W** 16 1/2" **D** 20 7/8" **H** 21 5/8"

3. Cassettiere | Pedestals | Blocs tiroirs | Cajoneras
Fin. ME **L** 45 **P** 58 **H** 55 cm | **W** 17 3/4" **D** 22 7/8" **H** 21 5/8"

Remo

Remo è un sistema di contenitori modulari e sovrapponibili con ante battenti e vani a giorno. L'intera scocca è composta da pannelli da 18 mm, mentre top e fondo sono spessi 30 mm.

Remo is a cabinets system made of modular and stackable units, with hinged doors or open shelving. The entire case is made of 18 mm (3/4") thick panels, while top and bottom are 30 mm (1 1/4") thick.

Ante | Doors | Portes | Puertas

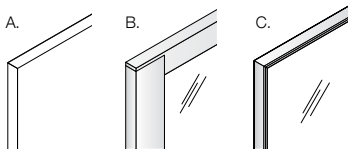

A. Senza profilo, B. Con profilo sp 50 mm, C. Con profilo 5 mm
 A. Without profile, B. With 50 mm (2") profile, C. With 5 mm (1/4") profile
 A. Sans profil, B. Avec profil ép. de 50 mm, C. Avec profil ép. de 5 mm
 A. Sin perfil, B. Con perfil esp. 50 mm, C. Con perfil esp. 5 mm

Remo est un système de armoires modulaires et empilables avec portes abatibles et compartiments ouverts. Le corps entier est composé de panneaux de 18 mm, tandis que le haut et le bas ont une épaisseur de 30 mm.

Remo es un sistema de contenedores modulares y apilables con puertas abatibles y compartimentos abiertos. El cuerpo entero está compuesto de paneles de 18 mm, mientras que el top superior y el suelo tienen un grosor de 30 mm.

Scocca
 Body
 Corps
 Cuerpo

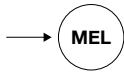

Ante
 Panels
 Panneaux
 Paneles



Ripiani
 Shelves
 Tablettes
 Estantes



Contenitori
 Cabinets
 Rangements
 Contenedores

Contenitori | Cabinets | Rangements | Contenedores

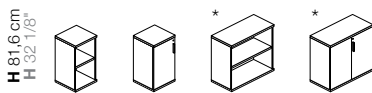

L 45/*90 - P 34/43,5 cm
 W 17 3/4*-*35 3/8* - D 13 3/8*-17 1/8*

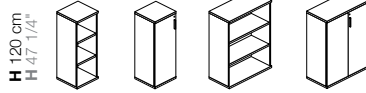

L 45/*90 - P 34/43,5 cm
 W 17 3/4*-*35 3/8* - D 13 3/8*-17 1/8*

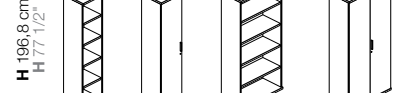

L 45/*90 - P 34/43,5 cm
 W 17 3/4*-*35 3/8* - D 13 3/8*-17 1/8*

Portapiante | Planter | Cache-pot | Jardinera

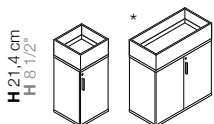

L 45/*90 - P 34/43,5 cm
 W 17 3/4*-*35 3/8* - D 13 3/8*-17 1/8*

Es. composizioni | Composition ex. | Ex. de compositions | Ej. de composiciones

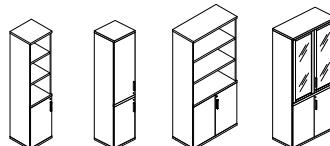



1.



1. Contenitore | Cabinet | Rangement | Contenedor
Fin. MD, MN **L** 90 **P** 43 **H** 81 cm | **W** 35 3/8" **D** 16 7/8" **H** 31 7/8"
Porta piante | Planter | Cache-pot | Jardinera
H 21 cm | **H** 8 1/4"

2. Contenitore | Cabinet | Rangement | Contenedor
Fin. MN, MC **L** 270 **P** 43 **H** 81 cm | **W** 106 1/4" **D** 16 7/8" **H** 31 7/8"

3. Contenitore | Cabinet | Rangement | Contenedor
Fin. MF, MN **L** 180 **P** 43 **H** 197 cm | **W** 70 7/8" **D** 16 7/8" **H** 77 1/2"



3.



1.

Ottanta/ Novanta

Ottanta e Novanta sono contenitori con ante battenti che differiscono tra loro per modularità: Ottanta ha larghezza 40 e 80 cm mentre Novanta ha larghezza 45 e 90 cm. I moduli sono sovrapponibili.

Ottanta and Novanta are cabinets systems with hinged doors that differ in modularity: Ottanta has 40 and 80 cm (15 3/4" and 31 1/2") width while Novanta has 45 and 90 cm (17 3/4" and 35 3/8") width. Modules can be stacked.

Ante | Doors | Portes | Puertas

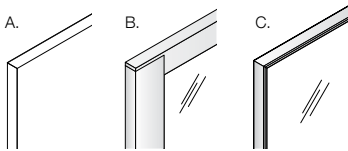

A. Senza profilo, B. Con profilo sp 50 mm, C. Con profilo 5 mm
 A. Without profile, B. With 50 mm (2") profile, C. With 5 mm (1/4") profile
 A. Sans profil, B. Avec profil ép. de 50 mm, C. Avec profil ép. de 5 mm
 A. Sin perfil, B. Con perfil esp. 50 mm, C. Con perfil esp. 5 mm

Ottanta et Novanta sont des rangements à portes battantes de modularité différente: Ottanta a 40 et 80 cm de largeur tandis que Novanta a une largeur de 45 et 90 cm. Les modules peuvent être empilés.

Ottanta y Novanta son contenedores con puertas abatibles que difieren entre sí para la modularidad: Ottanta tiene un ancho de 40 y 80 cm mientras que Novanta tiene un ancho de 45 y 90 cm. Los módulos son apilables.

Scocca
 Body
 Corps
 Cuerpo



Ante
 Panels
 Panneaux
 Paneles



Ripiani
 Shelves
 Tablettes
 Estantes



Contenitori
 Cabinets
 Rangements
 Contenedores

Contenitori | Cabinets | Rangements | Contenedores

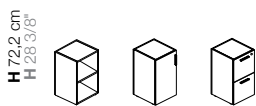

L 40/45 - P 43/50 cm
 W 15 3/4"-17 3/4" - D 16 7/8"-19 3/4"

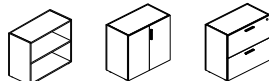

L 80/90 - P 43/50 cm
 W 31 1/2"-35 3/8" - D 16 7/8"-19 3/4"

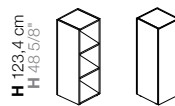

L 40/45 - P 43/50 cm
 W 15 3/4"-17 3/4" - D 16 7/8"-19 3/4"

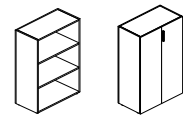

L 80/90 - P 43/50 cm
 W 31 1/2"-35 3/8" - D 16 7/8"-19 3/4"

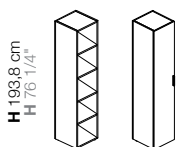

L 40/45 - P 43/50 cm
 W 15 3/4"-17 3/4" - D 16 7/8"-19 3/4"

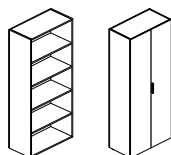

L 80/90 - P 43/50 cm
 W 31 1/2"-35 3/8" - D 16 7/8"-19 3/4"

Es. composizioni | Composition ex. | Ex. de composicions | Ej. de composiciones

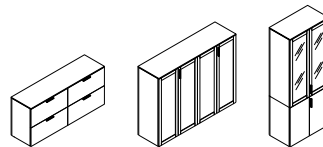



1. Contenitore | Cabinet | Rangement | Contenedor
Fin. MK, MI, BN **L** 320 **P** 43 **H** 123 cm | **W** 126" **D** 16 7/8" **H** 48 3/8"

2. Contenitore | Cabinet | Rangement | Contenedor
Fin. MO, BN **L** 180 **P** 43 **H** 194 cm | **W** 70 7/8" **D** 16 7/8" **H** 76 3/8"

3. Contenitore | Cabinet | Rangement | Contenedor
Fin. MI, MK **L** 90 **P** 43 **H** 72 cm | **W** 35 3/8" **D** 16 7/8" **H** 28 3/8"
Porta piante | Planter | Cache-pot | Jardinera
H 21 cm | **H** 8 1/4"



3.

Lato

.locker

Lato è un sistema di armadietti con scocca in melaminico disponibile in svariate combinazioni. I suoi moduli sono adatti ad archiviare documenti oppure effetti personali in contesti quali uffici, palestre, spogliatoi.

Lato is a modular locker system. Lato's modules can be used to store documents or personal belongings in offices, gyms or dressing rooms.

Lato est un système d'armoires avec structure en mélaminé disponible dans différentes combinaisons. Ses modules sont indiqués pour archiver documents ou effets personnels dans des contextes tels que bureaux, gymnases et vestiaires.

Lato es un sistema de casilleros con estructura en melamina disponible en varios colores. Sus módulos se pueden usar para almacenar documentos o efectos personales en contextos como oficinas, gimnasios, vestuarios.

Serrature | Locking systems | Serrures | Cerraduras

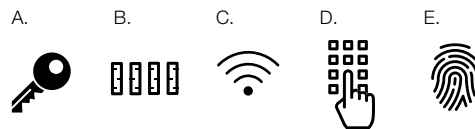

A. Chiave cifrata, B. Combinazione meccanica, C. RFID, D. Combinazione elettronica, E. Impronta digitale

A. Warded key, B. Mechanical combination, C. RFID, D. Electronic combination, E. Fingerprint
 A Clé chiffrée, B. Combinaison mécanique, C. RFID, D. Combinaison électronique, E. Empreinte digitale
 A. llave cifrada, B. Combinación mecánica, C. RFID, D. Combinación electrónica, E. Huellas dactilares



Contenitori
 Cabinets
 Rangements
 Contenedores

Scocca
 Body
 Corps
 Cuerpo



Ante
 Panels
 Panneaux
 Paneles



Piedi
 Feet
 Pieds
 Pies



Moduli | Modules | Modules | Módulos

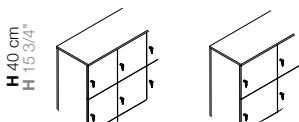

L 40/50 - P 43 cm
 W 15 3/4" - 19 3/4" - D 16 7/8"

Esempi | Examples | Exemples | Ejemplos

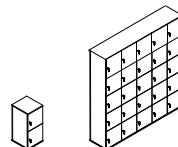

Numero moduli min/max
 Modules number min/max
 Nombre de modules min/max
 Número de módulos min/máx



1.

1. Contenitore | Cabinet | Rangement | Contenedor **Fin.** MK, MV
L 160 P 43 H 173 cm | W 63" D 16 7/8" H 68 1/8"

2. Contenitore | Cabinet | Rangement | Contenedor **Fin.** MN, MK, MI
L 250 P 43 H 93 cm | W 98 3/8" D 16 7/8" H 36 5/8"

3. Contenitore | Cabinet | Rangement | Contenedor **Fin.** MI, MN, MC, MK, MJ
L 200 P 43 H 125 cm | W 78 3/4" D 16 7/8" H 49 1/4"

4. Contenitore | Cabinet | Rangement | Contenedor **Fin.** MF, EB, EG, EI
L 200 P 43 H 125 cm | W 78 3/4" D 16 7/8" H 49 1/4"
Schiena in tessuto | Fabric back | Fond en tissu | Tresera de tejido







Romolo

I contenitori Romolo hanno due ante scorrevoli sovrapposte che possono essere in melaminico oppure in metacrilato intelaiato, oltre che abbinare a un vano a giorno superiore.

Romolo is a cabinets system with sliding doors that can be in melamine or framed acrylic. It is available in many widths and heights. An upper open shelving can be added to the sliding door storage.

Ante | Doors | Portes | Puertas

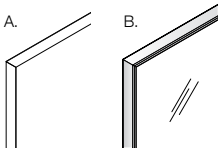

A. Senza profilo B. Con profilo sp 5 mm
 A. Without profile B. With 5 mm (1/4") profile
 A. Without profile B. Avec profil ép. de 5 mm
 A. Sin perfil B. Con perfil esp. 5 mm

Les rangements Romolo ont deux portes coulissantes chevauchées qui peuvent être réalisées en mélamine ou en méthacrylate avec cadre, et peuvent être combinées avec un compartiment supérieur ouvert.

Los contenedores Romolo tienen dos puertas deslizantes que se superponen y que pueden ser de melamina o metacrilato enmarcado. Pueden combinarse con un compartimento superior abierto.

Scocca
 Body
 Corps
 Cuerpo



Ante
 Panels
 Panneaux
 Paneles



Contenitori
 Cabinets
 Rangements
 Contenedores

Contenitori | Cabinets | Rangements | Contenedores

H 81,6 cm
 H 32 1/8"

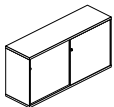

L 160/180/200/240 - P 37/47 cm
 W 63"-70 7/8"-78 3/4"-94 1/2" - D 14 5/8"-18 1/2"

H 120 cm
 H 47 1/4"

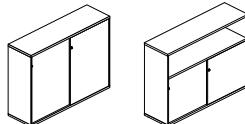

L 160/180/200/240 - P 37/47 cm
 W 63"-70 7/8"-78 3/4"-94 1/2" - D 14 5/8"-18 1/2"

H 196,8 cm
 H 77 1/2"

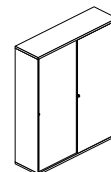

L 160/180/200/240 - P 37/47 cm
 W 63"-70 7/8"-78 3/4"-94 1/2" - D 14 5/8"-18 1/2"

Portapiante | Planter | Cache-pot | Jardinera

H 21,4 cm
 H 8 1/2"

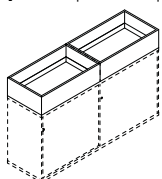

L 80/90/100/120 - P 37/47 cm
 W 31 5/8"-35 1/2"-39 1/2"-47 3/8" - D 14 5/8"-18 1/2"



1. Contenitore | Cabinet | Rangement | Contenedor **Fin.** MI, MK
L 200 **P** 47 **H** 120 cm | **W** 78 3/4" **D** 18 1/2" **H** 47 1/4"

2. Contenitore | Cabinet | Rangement | Contenedor **Fin.** MT, MZ
L 480 **P** 47 **H** 120 cm | **W** 189" **D** 18 1/2" **H** 47 1/4"

3. Contenitore | Cabinet | Rangement | Contenedor **Fin.** MK, MJ
L 160 **P** 47 **H** 81 cm | **W** 63" **D** 18 1/2" **H** 31 7/8"
Porta piante | Planter | Cache-pot | Jardinera
H 21 cm | **H** 8 1/4"



3.

Blade X

.credenza

Blade X presenta una serie di contenitori dedicati. Le ante hanno larghezza 70 cm e sono dotate di maniglia in metallo integrata e verniciata con lo stesso colore dei piedi metallici. È disponibile una versione con sezione a giorno e ripiani vetro fumé.

Blade X presents a series of dedicated credenzas. The doors are 70 cm (27 1/2") in width and are equipped with an integrated metal handle and painted in the same colour as the metal feet. A version with open storage and smoked glass shelves is available.

Blade X dispose de buffets spécifiques. Les portes sont en largeur 70 cm et disposent d'une poignée métallique intégrée dans la même finition que le piétement. Une version avec compartiment ouvert et étagère en verre fumé est également proposée.

Blade X presenta una serie de credenzas dedicado. Las puertas son de 70 cm de ancho y están equipadas con un mango de metal integrado y pintadas del mismo color que las patas de metal. Almacenamiento y estantes de vidrio ahumado está disponible.

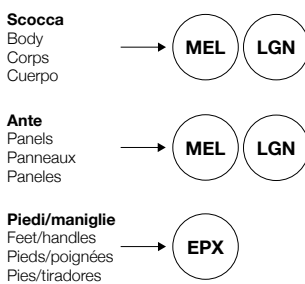

Credenze
Credenzas
Buffets
Credenzas

Credenze | Credenzas | Buffets | Credenzas

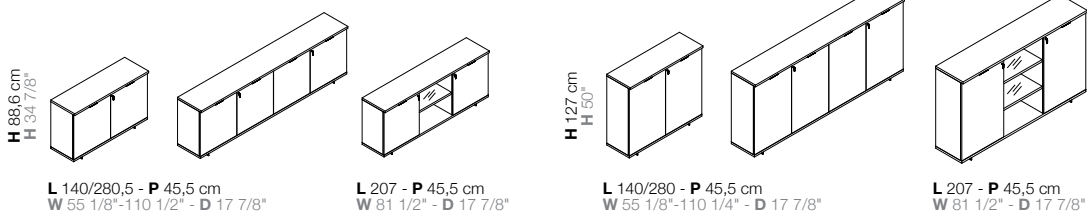



1.



1. Credenza | Credenza | Buffet | Credenza **Fin. AK, EO**
L 206 P 45 H 89 cm | W 81 1/8" D 17 3/4" H 35"

2. Credenza | Credenza | Buffet | Credenza **Fin. RG, EB**
L 280 P 45 H 89 cm | W 110 1/4" D 17 3/4" H 35"

3. Credenza | Credenza | Buffet | Credenza **Fin. RC, EN**
L 206 P 45 H 127 cm | W 81 1/8" D 17 3/4" H 50"



3.



1.

Oasi

.credenza

La credenza Oasi è disponibile in due versioni. La prima presenta due ante battenti laterali con maniglia integrata, un vano a giorno centrale con ripiano in vetro fumè e uno zoccolo frontale in metallo. La seconda ha invece 4 vani chiusi da ante e gambe in metallo verniciato che sollevano la scocca rispetto al pavimento.

The Oasi credenza is available in two versions, one has two side hinged doors with integrated handle and a central open compartment with smoked glass shelf and a metal front finish plinth. The second has instead 4 compartments closed by doors and legs in painted metal that lift the shell with respect to the floor.

Le buffet Oasi est disponible en deux versions, l'une avec 3 compartiments dont 2 portes battantes et un compartiments ouvert doté d'une étagère en verre fumé, en appui au sol avec pieds en métal et un socle centrale en métal peint. La seconde comporte au contraire 4 compartiments fermés par des portes et des pieds en métal peint qui soulèvent la structure du sol.

La credenza Oasi está disponible en dos versiones, una tiene dos puertas laterales con bisagras y manija integrada y un compartimiento central abierto con estante de vidrio ahumado y un zócalo de metal con acabado frontal. El segundo tiene en cambio 4 compartimentos cerrados por puertas y patas de metal pintado que levantan la carcasa con respecto al suelo.

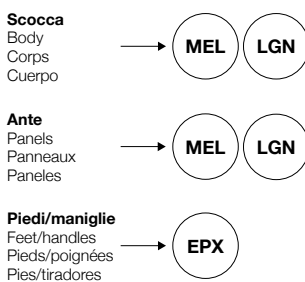

Credenze
Credenzas
Buffets
Credenzas

Credenze | Credenzas | Buffets | Credenzas

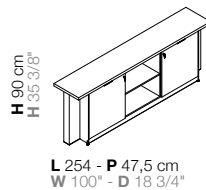
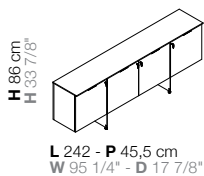

2.



1. Credenza | Credenza | Buffet | Credenza **Fin. AK, EZ**
L 242 P 45 H 86 cm | W 95 1/4" D 17 3/4" H 33 7/8"

2. Credenza | Credenza | Buffet | Credenza **Fin. ME, EI**
L 242 P 45 H 86 cm | W 95 1/4" D 17 3/4" H 33 7/8"

3. Credenza | Credenza | Buffet | Credenza **Fin. NT, EZ**
L 254 P 47 H 90 cm | W 100" D 18 1/2" H 35 3/8"



3.

Quattro

Quattro è il sistema di pareti attrezzate pensato per essere semplice ed economico ma allo stesso tempo molto versatile ed elegante. Anche un semplice gioco di colori tra ante e scocca rende le composizioni incredibilmente piacevoli. È composto interamente da pannelli in melaminico di spessore 30 mm, a eccezione di schiene e ante spesse 18 mm. Le ante battenti si possono sovrapporre, creando così composizioni dinamiche e adatte a diversi utilizzi. L'apertura è disponibile sia a 110° che a 180°.

Quattro is the wall storage system designed to be easy and economical but very versatile and elegant at the same time. Even a simple play of colours between doors and frame makes every composition incredibly pleasant. It is entirely made of 30 mm (1 1/4") thick melamine panels, except for doors and backs which are 18 mm (3/4") thick. Hinged doors can be stacked, thus creating dynamic compositions suitable for different uses. Opening is available both at 110° and 180°.

Quattro est le système d'armoire-paroi équipé conçu pour être simple et économique mais en même temps élégant et polyvalent. Même un simple jeu de couleurs entre portes et corp rend les compositions incroyablement agréables. Elle est entièrement composée par panneaux mélaminés de 30 mm d'épaisseur, sauf fond et portes qui ont une épaisseur de 18 mm. Les portes battentes de hauteur différentes peuvent être combinées, afin de créer composition dynamiques et adaptés à différentes utilisations. L'ouverture est disponible à 110° et 180°.

Quattro es el sistema de paredes equipadas diseñado para ser simple y barato pero al mismo tiempo muy versátil y elegante. También un simple juego de colores entre las puertas y el cuerpo hace las composiciones increíblemente agradables. Está compuesto en su totalidad por paneles de melamina de 30 mm de espesor, a excepción de las traseras y de las puertas que tienen 18 mm de espesor. Las puertas batientes se pueden superponer creando así composiciones dinámicas adecuadas para diferentes usos. La apertura está disponible tanto a 110° como a 180°.

Scocca
Body
Corps
Cuerpo



Ante
Panels
Panneaux
Paneles



Contentori
Cabinets
Rangements
Contentedores

Modularità | Modularity | Modularité | Modularidad

H 41,5/79,9/118,3/156,7/
195,1/233,5/271,9 cm
H 16 3/8"-31 1/2"-46 5/8"-61 3/4"
76 7/8"-92"-107 1/8"

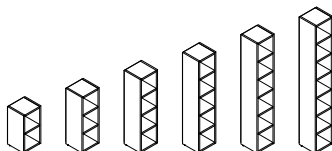

P 37/43/50/66 cm
D 14 5/8"-16 7/8"-19 3/4"-26"

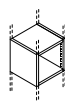

L 40/45/50 cm
W 15 3/4"-17 3/4"-19 3/4"

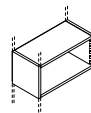

L 80/90/100 cm
W 31 1/2"-35 3/8"-39 3/8"



1.



2.

1. Contenitore | Cabinet | Rangement | Contenedor **Fin.** MI, MC
L 350 **P** 65 **H** 270 cm | **W** 137 3/4" **D** 25 5/8" **H** 106 1/4"

2. Contenitore | Cabinet | Rangement | Contenedor **Fin.** MN,
MI, MY **L** 500 **P** 50 **H** 230 cm | **W** 196 7/8" **D** 19 3/4" **H** 90 1/2"

3. Contenitore | Cabinet | Rangement | Contenedor **Fin.** MD
L 670 **P** 50 **H** 230 cm | **W** 263 3/4" **D** 19 3/4" **H** 90 1/2"

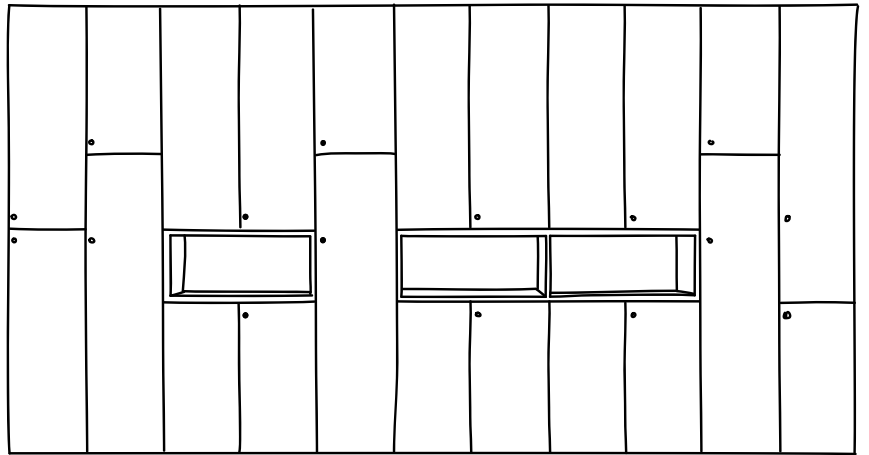

3.



accessori

Accessories
Accessoires
Accesorios

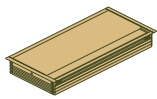

268

**Moduli
elettrificati**

Power modules
Modules d'électrification
Módulos de electrificación



270

**Elettrificazione
verticale**

Vertical cable management
Électrification verticale
Electrificación vertical



Basic

PLA*

*Nero
*Black
*Noir
*Negro



Magic Top

EPX



Flip-Top

EPX



Passacavi rotondo | Round grommet |
Passecables rond | Pasacables redondo

CRM

PLA*

*Nero-Bianco-Grigio
*Black-White-Grey
*Noir-Blanc-Gris
*Negro-Blanco-Gris



Flat

EPX

LGN



Cover

EPX



Dot

PLA*

*Nero o bianco
*Black or white
*Noir ou blanc
*Negro o blanco

Moduli elettrificati

Power modules | Modules d'électrification | Módulos de electrificación

I moduli per elettrificazione Alea possono essere di tipo passacavi (Magic Top, Flip Top e Passacavi rotondo) da abbinare all'elemento Basic (ciabatta configurabile), oppure possono avere prese integrate, come per Flat, Cover e Dot. Le prese elettriche disponibili sono: Schuko, presa Unel, presa Francia/Belgio, presa svizzera e presa inglese, USB charger. Mentre i dispositivi per la gestione dati sono: RJ, HDMI, USB dati.

I moduli elettrificati, a seconda della versione, sono disponibili in varie finiture/materiali.

Alea's electrification modules can be of the grommet type (Magic Top, Flip Top and round Grommet) to be combined with the Basic element (configurable power strip), or they can have integrated sockets, as for Flat, Cover and Dot. The available sockets are: Schuko, Unel socket, France/Belgium socket, Swiss socket and English socket, USB charger. While the data devices are: RJ, HDMI, USB data.

Depending on the version, the electrified modules are available in various finishes/materials.

Les modules d'électrification Alea peuvent être de type passe-câbles (Magic Top, Flip Top et Passe-câbles rond) à assortir avec l'élément Basic (multiprise configurable), ou ils peuvent avoir des prises intégrées, soit Flat, Cover et Dot. Les prises de courant disponibles sont: Schuko, prise Unel, prise France/Belgique, prise Suisse et prise Anglaise, USB chargeur. Les dispositifs de gestion des données sont: RJ, HDMI, données USB.

Les modules électrofiés, selon la version, sont disponibles en différentes finitions/matériaux.

Los módulos de electrificación Alea pueden ser de tipo pasacables (Magic Top, Flip Top y Pasacable redondo) para combinar con el elemento Basic (regleta configurable), o pueden llevar tomas de corriente integradas, como en el caso de Flat, Cover y Dot. Las tomas de corriente disponibles son: Enchufe Schuko, enchufe Unel, enchufe Francia/Bélgica, enchufe suizo y enchufe inglés, cargador USB. En cambio los dispositivos para la gestión de datos son: RJ, HDMI, USB.

Dependiendo de la versión, los módulos electrificados están disponibles en varios acabados/materiales.

Elettificazione verticale

Vertical cable management | Électrification verticale |
Electrificación vertical

L'elettificazione verticale può essere invece realizzata con vertebre (A) in policarbonato traslucido fissate ai piani, con guaine raccogli-cavi in plastica (B) o con guaine passacavi in rete (C) del diametro di 30 mm realizzate in PET di colore bianco o nero che possono essere tagliate a misura in loco.

Vertical electrification can be provided with a translucent polycarbonate spine wire management system (A) secured to tops, plastic cable tidy sleeving (B) or with 30 mm (1 1/4") diameter cable management mesh (C) made of PET in white or black colour that can be cut to size on site.

Pour l'électrification verticale sont disponibles les vertèbres (A) en polycarbonate translucide fixées aux plans, gaines en plastique (B), ou gaines passe-câbles (C) de 30 mm de diamètre en PET de couleur blanche ou noire qui peuvent être découpés sur place.

La electrificación vertical puede realizarse con vértebras (A) de policarbonato translúcido fijadas en los tableros, con cubiertas flexibles de plástico (B) o con cubierta flexible en red (C) para cables D. 30 mm hechas de PET blanco o negro que pueden ser cortadas a medida en el sitio.





274
F40

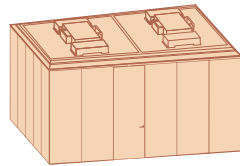

282
F65

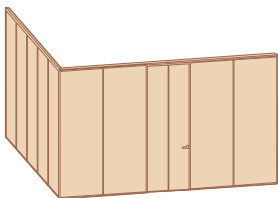

288
A65



1.

F40

Negli spazi ampi nasce il bisogno di isolarsi per una call oppure per un meeting privato, o più semplicemente per ricavarci un momento di concentrazione maggiore. La collezione di cabine e pods F40 nasce proprio per rispondere a queste esigenze. Si distingue per il design lineare e la rapidità di assemblaggio in cantiere, con conseguente abbattimento dei costi per il cliente. F40 viene presentato nelle dimensioni standard 122,4x100 cm (One), 222,4x100 cm (Two), 222,4x220 cm (Four), 262,4x260 cm (Six), 262,4x345 cm (Eight) e dispone di una gamma di arredi interni dedicati ed opzionali, per chi desidera un pacchetto completo.

In large spaces there is a need to isolate oneself for a call or a private meeting, or simply to find a moment of greater concentration. The F40 pods and phone booths collection was created to meet these needs. It stands out for its linear design and rapidity of assembly on site, with consequent reduction of costs for the customer. F40 is presented in the standard dimensions: One 122,4x100 cm (48 1/4"x39 3/8"), Two 222,4x100 cm (87 5/8"x39 3/8"), Four 222,4x220 cm (87 5/8"x 86 5/8"), Six 262,4x260 cm (103 3/8"x 102 3/8"), Eight 262,4x345 cm (103 3/8"x 135 7/8") and has a range of dedicated and optional interior furnishings, for those who want a complete package.

Dans les grands espaces, il est nécessaire de s'isoler pour un appel ou une réunion privée, ou simplement pour trouver un moment de plus grande concentration. La collection de pods et cabines F40 a été créée pour répondre à ces besoins. Il se distingue par sa conception linéaire et la rapidité de son montage sur site, avec une réduction conséquente des coûts pour le client. F40 est présenté dans les dimensions standard 122,4x100 cm (One), 222,4x100 cm (Two), 222,4x220 cm (Four), 262,4x260 cm (Six), 262,4x345 cm (Eight) et dispose d'une gamme d'aménagements intérieurs dédiés et optionnels, pour ceux qui veulent un ensemble complet.

En los grandes espacios surge la necesidad de aislarse para una llamada o una reunión privada, o simplemente para encontrar un momento de mayor concentración. La colección de pods y cabinas F40 se creó para satisfacer estas necesidades. Destaca por su diseño lineal y la rapidez de montaje en obra, con la consiguiente reducción de costes para el cliente. F40 se presenta en los tamaños estándar 122,4x100 cm (One), 222,4x100 cm (Two), 222,4x220 cm (Four), 262,4x260 cm (Six), 262,4x345 cm (Eight) y cuenta con una gama de mobiliario interior dedicado y opcional, para quienes deseen un paquete completo.

Pannelli esterni
External panels
Panneaux extérieurs
Paneles exteriores



Pannelli fonoassorbenti
Acoustic panels
Panneaux insonorisants
Paneles fonoabsorbentes

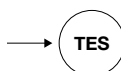

Privacy
Privacy
Privacy
Privacidad



Relax
Relax
Relax
Relax



Riunioni
Meeting
Réunions
Reuniones





3.

Cabine acustiche | Acoustic pods | Cabines acoustiques | Cabinas acústicas

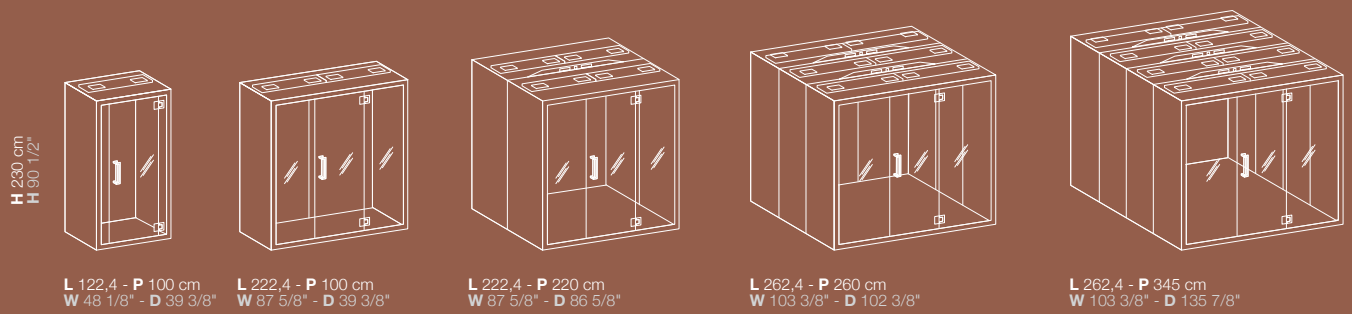

Opzioni allestimento | Outfitting options | Options d'équipement | Opciones de equipamiento

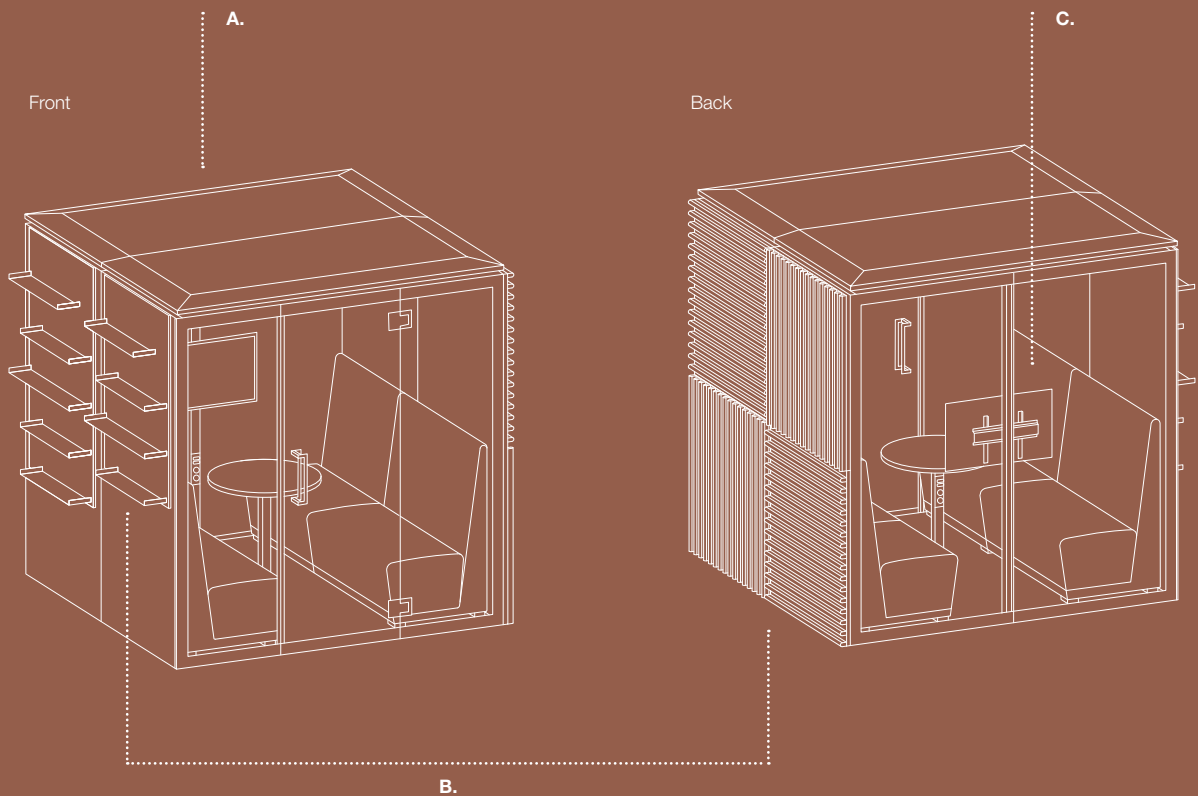

A.

Accessori interni:

- ventilazione/illuminazione dimmerabile
- impianto di condizionamento
- sanificatore d'aria

Interior accessories:

- dimmable ventilation/lighting
- air conditioning system
- air sanitiser

Accessoires intérieurs:

- ventilation/éclairage à gradation
- système de climatisation
- assainisseur d'air

Accesorios interiores:

- ventilación/iluminación regulable
- sistema de aire acondicionado
- higienizador de aire

B.

Accessori esterni:

- pannelli fonoassorbenti decorati con listoni in legno
- mensole in metallo
- schiena scrivibile

External accessories:

- sound-absorbing panels decorated with wooden planks
- metal shelves
- writable back

Accessoires externes:

- panneaux insonorisants décorés de planches de bois
- étagères en métal
- panneau arrière inscriptible

Accesorios externos:

- paneles fonoabsorbentes decorados con tablas de madera
- estantes metálicos
- trasera escribible

C.

Arredo interno:

- divanetti
- tavoli/mensole elettrificati
- porta TV

Interior furniture:

- sofas
- electrified tables/shelves
- TV stands

Mobilier intérieur:

- canapé
- tables/étagères électrifiées
- support écran TV

Mobiliario interior:

- sofás
- mesas/estanterías electrificadas
- soportes de TV



4.

- 1. One Fin.** DC, ML
L 122,4 P 100 H 230 cm | W 48 1/4" D 39 3/8" H 90 5/8"
- 2. Two Fin.** DG, MD
L 222,4 P 100 H 230 cm | W 87 5/8" D 39 3/8" H 90 5/8"
- 3. Four Fin.** DI, MI, EK, ET
L 222,4 P 220 H 230 cm | W 87 5/8" D 86 5/8" H 90 5/8"
- 4. Six Fin.** DC, MI
L 262,4 P 260 H 230 cm | W 103 3/8" D 102 3/8" H 90 5/8"
- 5. Eight Fin.** DC, UV Print
L 262,4 P 345 H 230 cm | W 103 3/8" D 135 7/8" H 90 5/8"





F65

F65 è un sistema freestanding di pareti mobili per la creazione di cellule multifunzione di grande comfort e privacy all'interno di spazi open-space. F65 è adatto a soluzioni su richiesta, anche di grandi dimensioni.

F65 is a freestanding system of movable walls for the creation of multifunctional cells of great comfort and privacy in open spaces. F65 is designed for solutions on demand, especially in big sizes.

F65 est un système autoportant, composé de cloisons mobiles qui permettent de créer des cellules multifonctionnelles, en offrant une grande confidentialité dans les "open space". F65 convient aux solutions à la demande, en particulier aux installations de grande envergure.

F65 es un sistema independiente de paredes móviles para la creación de módulos multifuncionales de gran comodidad y privacidad en espacios abiertos. F65 es adecuado para soluciones a petición, especialmente las de gran tamaño.

Pannelli esterni
External panels
Panneaux extérieurs
Paneles exteriores



Pannelli fonoassorbenti
Acoustic panels
Panneaux insonorisants
Paneles fonoabsorbentes

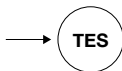

Struttura
Structure
Structure
Estructura



Layout
Layout
Layout
Layout



Privacy
Privacy
Privacy
Privacidad



Uffici privati
Private offices
Bureaux privés
Oficinas privadas



Riunioni
Meeting
Réunions
Reuniones





Es. configurazioni | configurations ex. |
ex. de configuracions | ej. de configuraciones

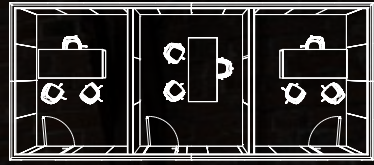
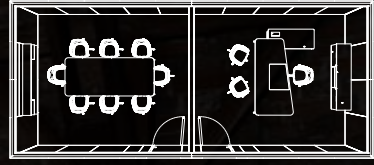

F65 3000 x 3000 mm +
118 1/8" x 118 1/8" +

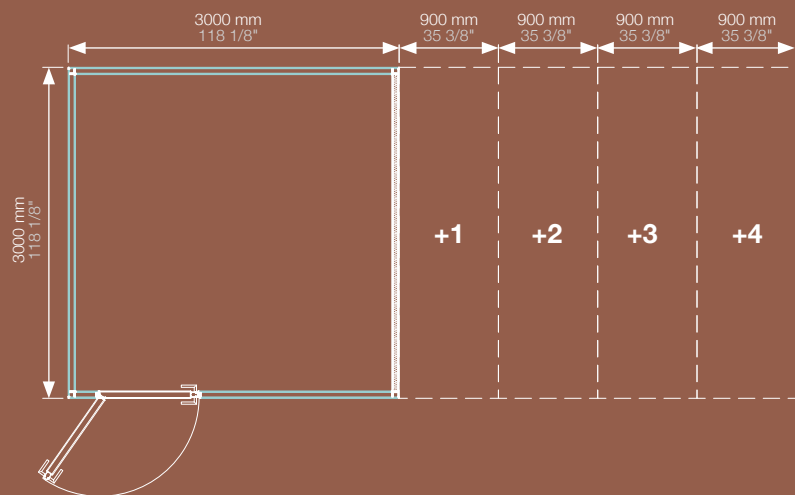

Pianta
 Plan view
 Vue en plan
 Vista en planta

F65 4000 x 4000 mm +
157 1/2" x 157 1/2" +

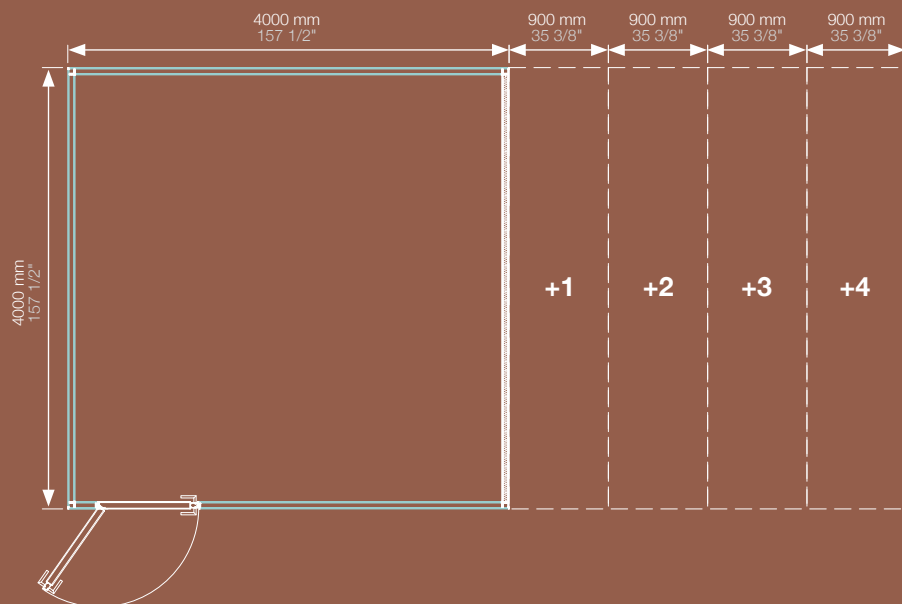

Pianta
 Plan view
 Vue en plan
 Vista en planta

F65 H 2300 mm
90 1/2"

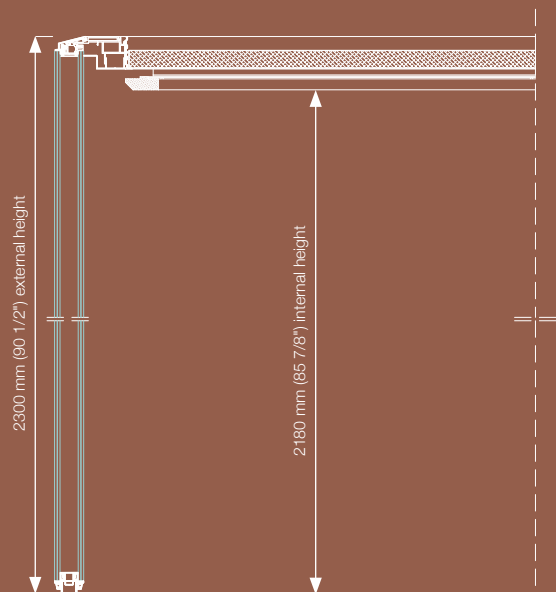

Sezione verticale
 Vertical section
 Section vertical
 Seccion vertical





A65

A65 è la parete divisoria modulare di Alea. Disponibile con vetro singolo, vetro doppio oppure pannelli ciechi, attrezzabile con porte battenti o scorrevoli.

Si caratterizza per un design minimalista che ne esalta la trasparenza. La coplanarità di porte e pannelli parete permettono di avere una continuità superficiale.

Le pareti sono disponibili in due tipologie, Standard ed Evo, per rispondere al meglio alle diverse esigenze progettuali.

A65 is Alea's modular partition wall, available in single-glazed, double-glazed or solid panel versions, which can be fitted with hinged or sliding doors.

Its minimalist design enhances the transparency and flushness between doors and wall elements, allowing for surface continuity.

Partition walls are available in two types, Standard and Evo, to best meet different design requirements.

A65 est la cloison de séparation modulaire d'Alea. Disponible en simple vitrage, double vitrage ou panneaux pleins, il peut être équipé de portes battantes ou coulissantes.

Il se caractérise par un design minimaliste qui améliore sa transparence, la coplanarité des portes et des panneaux muraux permet une continuité de surface.

Les cloisons de séparation sont disponibles en deux versions, Standard et Evo, pour répondre au mieux aux différentes exigences de conception.

A65 es la mampara divisoria de Alea. Disponible con cristal único, cristal doble o paneles ciegos, puede equiparse con puertas batientes o correderas.

Se caracteriza por un diseño minimalista que realza su transparencia. Además, la coplanaridad de las puertas y los paneles de pared permiten la continuidad de la superficie.

Las mamparas divisorias están disponibles en dos tipologías, Standard y Evo, para responder mejor a los diferentes requisitos de diseño.

Pannelli esterni
External panels
Panneaux extérieurs
Paneles exteriores



Struttura
Structure
Structure
Estructura



Layout
Layout
Layout
Layout



Privacy
Privacy
Privacy
Privacidad



Uffici privati
Private offices
Bureaux privés
Oficinas privadas



Riunioni
Meeting
Réunions
Reuniones



Dettaglio sezione
Section detail
Détail de la section
Detalle de la sección

Angoli curvi
Curved corners
Angles arrondis
Esquinas curvas



Tipologie maniglia | Handle types | Types de poignées | Tipología de tiradores



Man 001.1



Man 001.2



Alea Design Pull Handle

Tipologie profilo | Profile types | Types de profil | Tipología de perfil



Standard



Design minimal
Minimal design
Design minimaliste
Diseño minimalista



Evo



Regolabile
Adjustable
Réglable
Regolabile

Profilo Standard | Standard profile | Profil Standard | Perfil Standard

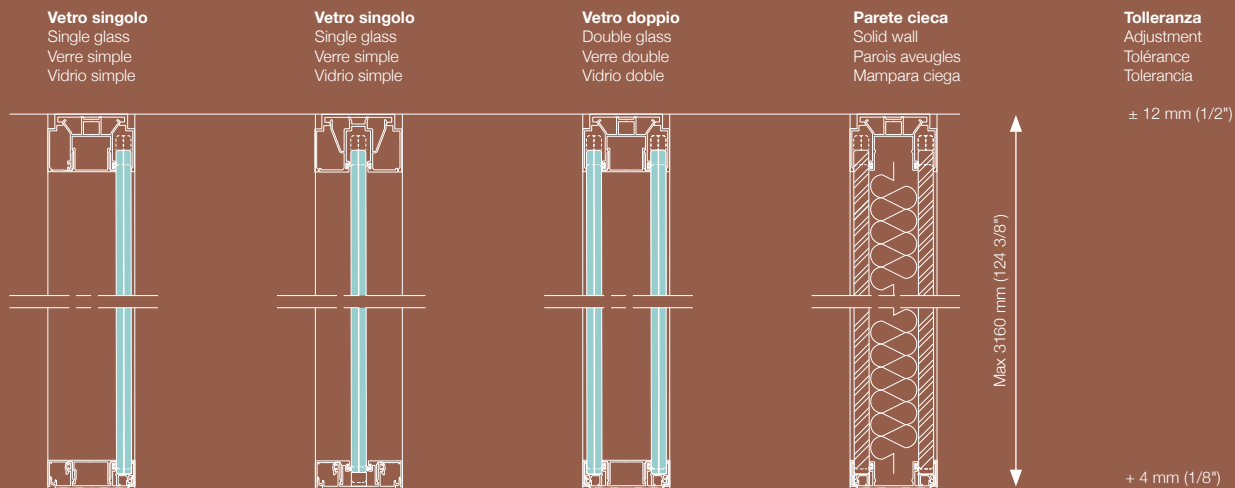

Profilo Evo | Evo profile | Profil Evo | Perfil Evo

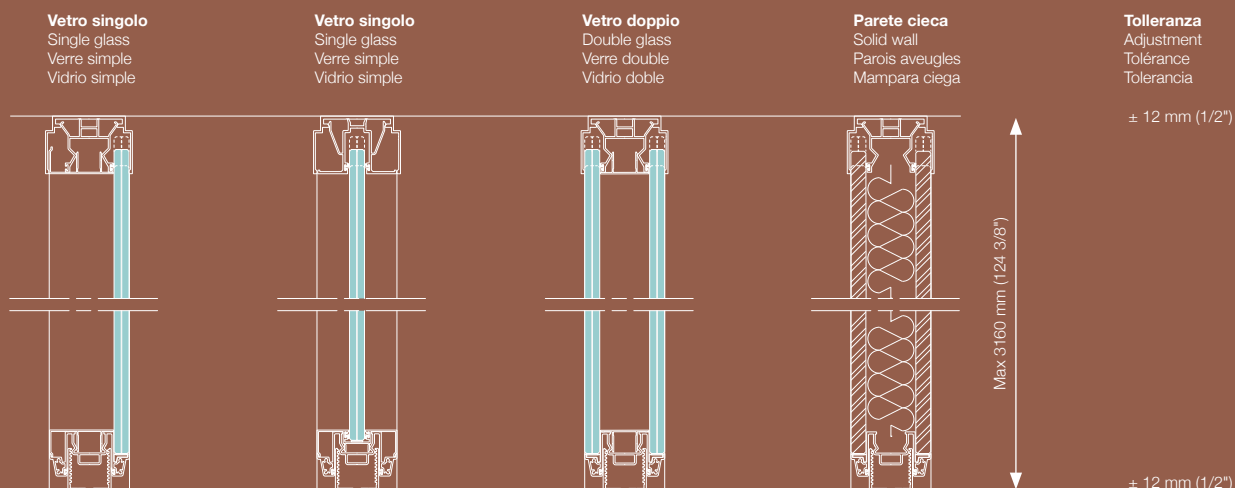

Angoli curvi - Profilo Standard

Curved corners - Standard profile | Angles arrondis - Profil Standard | Esquinas curvas - Perfil Standard

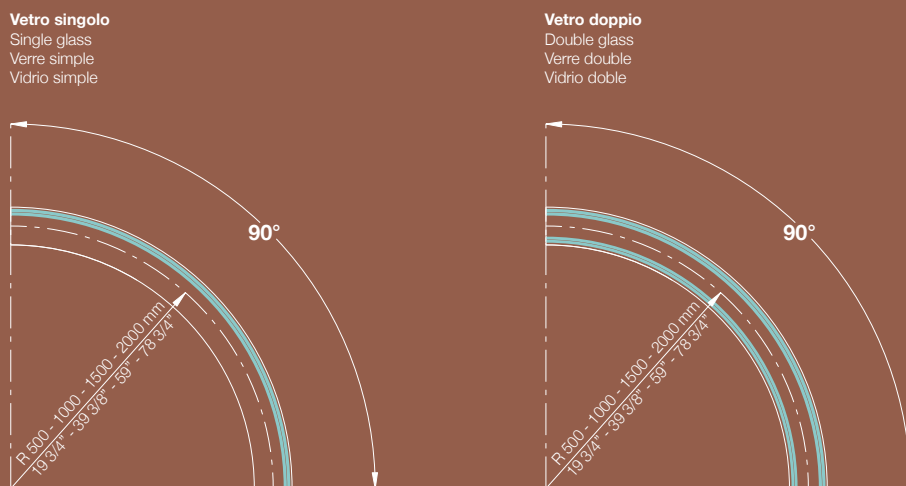

Porte | Doors | Portes | Puertas

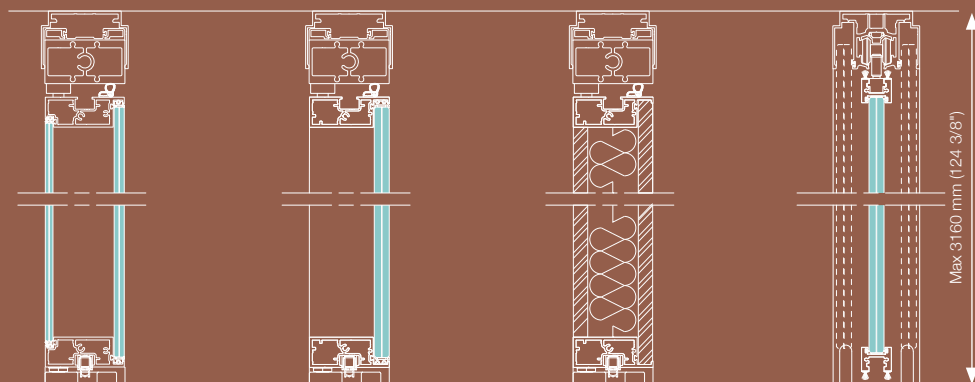

Vetro doppio
Double glass
Verre double
Vidrio doble

Vetro singolo
Single glass
Verre simple
Vidrio simple

Cieca
Solid door
Aveugle
Ciega

Scorrevole
Sliding door
Coulissante
Corredera

Sezioni verticali
Vertical section
Sections verticales
Secciones verticales

Porte battenti | Pivot doors | Portes pivotantes | Puertas batientes

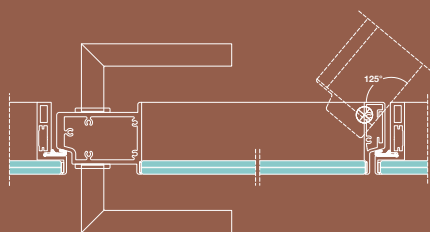

600 - 1150 mm
23 5/8" - 45 1/4"

Vetro singolo
Single glass
Verre simple
Vidrio simple

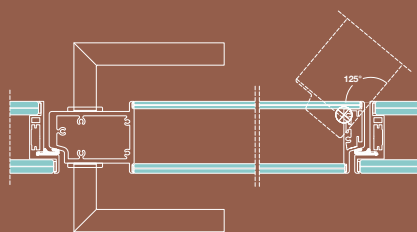

600 - 1150 mm
23 5/8" - 45 1/4"

Vetro doppio
Double glass
Verre double
Vidrio doble

Sezioni orizzontali
Horizontal section
Sections horizontales
Secciones horizontales

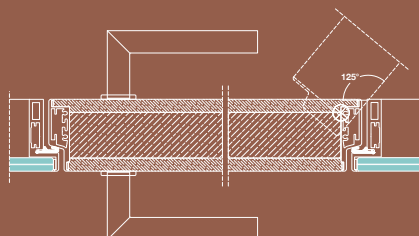

600 - 1150 mm
23 5/8" - 45 1/4"

Cieca
Solid door
Aveugle
Ciega

Porte scorrevoli | Sliding doors | Portes coulissantes | Puertas correderas

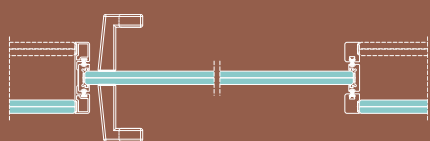

600 - 1300 mm
23 5/8" - 51 1/8"

Vetro singolo
Single glass
Verre simple
Vidrio simple

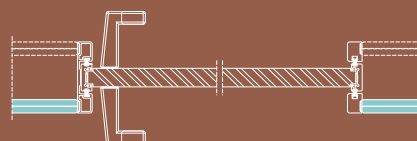

600 - 1300 mm
23 5/8" - 51 1/8"

Cieca
Solid door
Aveugle
Ciega

Sezioni orizzontali
Horizontal section
Sections horizontales
Secciones horizontales





materiali e finiture

Materials and finishes
Matériaux et finitions
Materiales y acabados



Melaminico

Melamine | Mélaminé | Melamina



Bianco rigato
Rippled effect white
Blanc avec rayures en sérigraphie
Blanco rayado



Grigio rigato
Rippled effect grey
Gris avec rayures en sérigraphie
Gris rayado



Nichel
Nickel
Nickel
Niquel



Cacao
Cocoa
Cacao
Cacao



Bianco
White
Blanc
Blanco

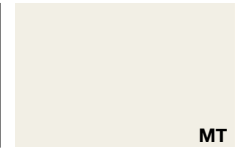

Talco
Talco
Talco
Talco



Ocra
Ochre
Ocre
Ocre



Terracotta
Terracotta
Terre cuite
Terracota



Safari
Safari
Safari
Safari



Noisette
Noisette
Noisette
Noisette



Verde
Green
Vert
Verde

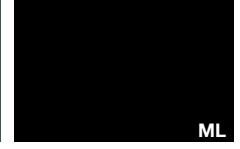

Nero
Black
Noir
Negro



Blu notte
Night blue
Bleu nuit
Azul noche

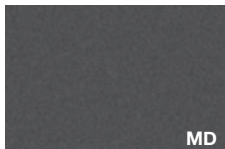

Ardesia
Ardesia
Ardesia
Ardesia



Rovere chiaro
Light oak
Chêne clair
Roble claro



Rovere americano
American oak
Chêne américain
Roble americano



Rovere grigio
Grey oak
Chêne gris
Roble gris



Rovere moro
Dark oak
Chêne foncé
Roble oscuro



Noce Canaletto
Canaletto Walnut
Noyer Canaletto
Nogal Canaletto



Noce scuro
Dark walnut
Noyer foncé
Nogal oscuro



Legno

Wood | Bois | Madera



Rovere chiaro
Light oak
Chêne clair
Roble claro



Rovere grigio fumo
Smoke grey oak
Chêne gris de fumée
Roble gris humo



Rovere moro
Dark oak
Chêne foncé
Roble oscuro



Noce Canaletto
Canaletto Walnut
Noyer Canaletto
Nogal Canaletto



Ebano Silver
Silver ebony
Ebony Silver
Ebano plata



Ebano Makassar
Makassar ebony
Ebony Makassar
Ebano Makassar



Noce termocotto
Heat-treated walnut
Noyer thermo traité
Nogal termotratado

FNX Fenix
Fenix | Fenix | Fenix



Bianco
White
Blanc
Blanco

Beige Arizona
Arizona beige
Beige Arizona
Beige Arizona

Blu Fes
Fes blue
Bleu Fes
Azul Fes

Grigio Bromo
Bromo grey
Gris Bromo
Gris Bromo

Verde Comodoro
Comodoro green
Vert Comodoro
Verde Comodoro

Nero
Black
Noir
Negro



Rosso Jaipur
Jaipur red
Rouge Jaipur
Rojo Jaipur

VTR Vetro
Glass | Verre | Vidrio

NFG Vetro antimpronta
Antifinger glass | Verre antitaches | Vidrio anti-huella

GOF Goffrato
Embossed | Gaufré | Lacado



Bianco
White
Blanc
Blanco

Argento
Silver
Argent
Plata

Grigio scuro
Dark grey
Gris foncé
Gris oscuro

Noisette
Noisette
Noisette
Noisette

Ardesia
Ardesia
Ardesia
Ardesia

Moka
Mocha
Moka
Cafe



Nero
Black
Noir
Negro

Arancione
Orange
Orange
Naranja

Rosso "F"
Red "F"
Rouge "F"
Rojo "F"

Rubino
Ruby
Rubis
Rubi

Indaco
Indigo
Indigo
Azul Indigo

Azzurro
Blue
Bleu
Azul



Verde
Green
Vert
Verde

Cedro
Lime green
Vert Cédtrat
Verde Cedro



Gres

Porcelain tiles | Grès cérame | Gres porcelánico



JN

Nero
Black
Noir
Negro

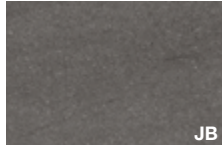

JB

Basalt
Basalt
Basalt
Basalt



JC

Calacatta
Calacatta
Calacatta
Calacatta



JP

Pulpis
Pulpis
Pulpis
Pulpis



JR

Corten
Corten
Corten
Corten



Cuoio

Leather | Cuir | Cuero

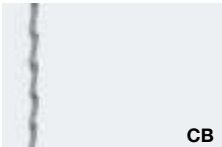

CB

Bianco
White
Blanc
Blanco



CU

Alluminio
Aluminium
Aluminium
Aluminio



CN

Nero
Black
Noir
Negro



CM

Testa di moro
Brown
Tête de maure
Marron oscuro



CE

Caramello
Caramel
Caramel
Caramelo



CA

Arancione
Orange
Orange
Naranja



Metacrilato

Acrylic | Méthacrylate | Metacrilato



BP

Bianco opalino
Opaline white
Blanc opalin
Blanco opaco



TR

Trasparente
Transparent
Transparent
Transparente



RS

Rosso trasparente
Red transparent
Rouge transparent
Rojo transparente



BL

Blu trasparente
Blue transparent
Bleu transparent
Azul transparente



BN

Bianco satinato
Satin-finish white
Blanc satiné
Blanco satinado



FU

Grigio fumè satinato
Satin-finish smoky grey
Gris satiné
Gris satinado



AR

Arancione satinato
Satin-finish orange
Orange satiné
Naranja satinado



BT

Blu satinato
Satin-finish blue
Bleu satiné
Azul satinado



VV

Verde satinato
Satin-finish green
Vert satiné
Verde satinado



Feltro

Felt | Rasselie | Fieltro



Sabbia
Cream
Sable
Arena



Grigio chiaro
Light grey
Gris clair
Gris claro



Grigio scuro
Dark grey
Gris foncé
Gris oscuro



Blu melange
Melange blue
Bleu mélangé
Azul melange



Verde scuro
Dark green
Vert foncé
Verde oscuro



Marrone
Brown
Marron
Marrón



Rosso bordeaux
Burgundy red
Rouge bordeaux
Rojo burdeos



Techpanel

Techpanel | Techpanel | Paño

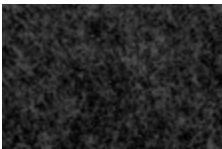

Dark grey
Dark grey
Gris foncé
Gris oscuro

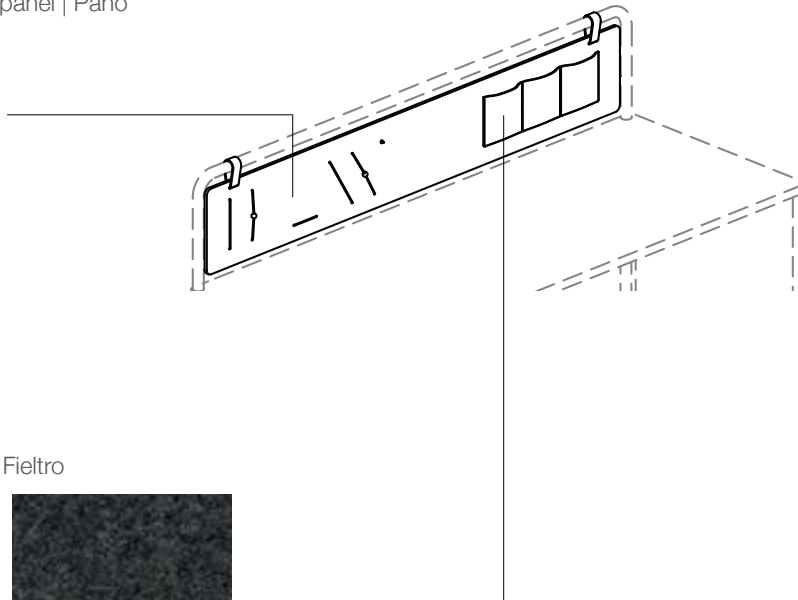

Feltro

Felt | Rasselie | Fieltro

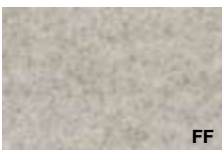

Sabbia
Cream
Sable
Arena



Grigio scuro
Dark grey
Gris foncé
Gris oscuro



Tessuto

Fabric | Tissu | Tejido



DC

Beige
Beige
Beige
Beige



DH

Grigio chiaro
Light grey
Gris clair
Gris claro



DI

Ardesia
Ardesia
Ardesia
Ardesia



DD

Blu avio
Avio blue
Bleu avio
Azul avio



DE

Acquamarina
Aquamarine
Aigue-marine
Aguamarina



DF

Verde primavera
Spring green
Vert printemps
Verde primavera



DG

Salvia
Sage
Sauge
Salvia



DB

Arancio
Orange
Orange
Naranja



DA

Corallo
Coral
Corail
Coral



OSB

OSB | OSB | OSB



OSB

OSB
OSB
OSB
OSB



Epossidico

Epoxy | Époxy | Epoxi



EB

Bianco
White
Blanc
Blanco

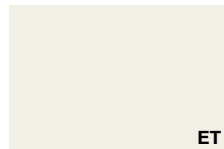

ET

Talco
Talco
Talco
Talco



EG

Grigio
Grey
Gris
Gris



YD

Beige Arizona
Arizona beige
Beige Arizona
Beige Arizona



EO

Noisette
Noisette
Noisette
Noisette



EK

Safari
Safari
Safari
Safari

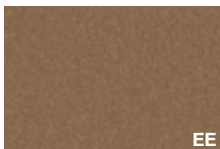

EE

Rame
Copper
Cuivre
Cobre

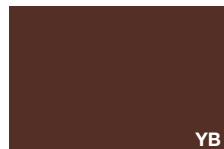

YB

Rosso Jaipur
Jaipur red
Rouge Jaipur
Rojo Jaipur



EZ

Bronzo
Bronze
Bronze
Bronce



YQ

Blu notte
Night blue
Bleu nuit
Azul noche



YC

Grigio Bromo
Bromo grey
Gris Bromo
Gris Bromo



EI

Ardesia
Ardesia
Ardesia
Ardesia



YV

Verde Comodoro
Comodoro green
Vert Comodoro
Verde Comodoro

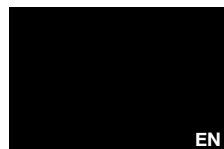

EN

Nero
Black
Noir
Negro

AL

Alluminio

Aluminium | Aluminium | Aluminio



Alluminio

Aluminium
Aluminium
Aluminio

BR

Brill

Brill | Brill | Brill



Brill

Brill
Brill
Brill

CRM

Inox lucido

Stainless Steel | Inox brossé poli | Acero inoxidable



Inox lucido

Stainless Steel
Inox brossé poli
Acero inoxidable

Concept, visual & graphic design

Alea marketing + communication

Design

Mirto Antonel

Art direction

Mirto Antonel

Si ringrazia m | artedesign

martedesign.it

AE/CACE/CL

Le immagini dei prodotti visibili all'interno di questo catalogo sono inserite a scopo puramente indicativo

The images of the products visible in this catalogue are included for information purposes only

Les images des produits visibles dans ce catalogue sont incluses à titre informatif uniquement

Las imágenes de los productos visibles en este catálogo se incluyen sólo con fines informativos

alea
aleaoffice.com



ALEA HQ AND SHOWROOM: Via Col de Rust, 19 - 33070 Sarone di Caneva (PN), Italia - tel +39 0434 777333
www.aleaoffice.com - email info@aleaoffice.com **MILAN SHOWROOM:** Via Cino del Duca, 2 - 20122 Milano, Italia - email info@aleaoffice.com
PARIS SHOWROOM: 176 Avenue Charles de Gaulle - 92200 Neuilly-sur-Seine, France - email france@aleaoffice.com
LONDON SHOWROOM: 50-54 Clerkenwell Road - London, EC1M 5PS - email ukoffice@aleaoffice.com **NEW YORK SHOWROOM:**
25W, 31st Street, #9 - New York, NY 10001, USA - tel +1 305 4701200 - email info@alea-usa.com **MIAMI SHOWROOM:**
Midtown 2, 3449 NE 1st Avenue L-32 - Miami, FL 33137, USA - tel +1 305 4701200 - email info@alea-usa.com