

alea

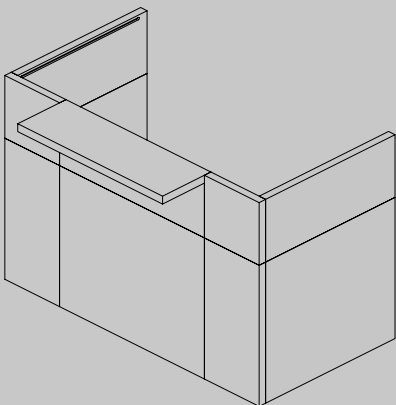

Philo

reception | receptions | accueils | recepciones

PHILO

The PHILO reception counter comprises 40mm thick chipboard panels, available with different melamine finishes and in a variety of coloured lacquers. The front and side walls are divided into two joined vertical panels, providing creative colour combinations. The reception top is available in back-lacquered glass with an aluminium profile with polished brushed finish or wood finish.

La banque d'accueil PHILO est composée de panneaux en bois de 40 mm d'épaisseur, disponibles en différentes finitions de mélamine et en de nombreux coloris laqués. Les panneaux avant et latéraux sont formés de deux bandes verticales assemblées entre elles et permettant d'associer avec créativité plusieurs coloris. Le plateau supérieur est disponible en verre rétro laqué avec un profil en aluminium brossé brillant ou bien en finition bois.

Das Rezeptionspult PHILO besteht aus Holzplatten Stärke 40 mm, die in verschiedenen Melaminausführungen und vielen Farblackierungen zur Auswahl stehen. Die vorderen und seitlichen Paneele sind in zwei senkrechte, miteinander verbundene Felder unterteilt, wodurch viele kreative Farbkombinationen möglich sind. Die Rezeptionsplatte steht in rückseitig lackiertem Glas mit Profil aus glänzendem gebürstetem Aluminium oder in Holzausführung zur Verfügung.

El banco de recepción PHILO utiliza paneles de madera de 40 mm de espesor disponibles en varios acabados melamínicos y en numerosos colores lacados. Las paredes frontales y laterales están divididas en dos franjas verticales unidas entre sí, lo que permite realizar creativas combinaciones de color. La encimera está disponible en cristal retrolacado con perfil de aluminio cepillado brillante o en acabado madera.

La reception PHILO utilizza pannelli lignei di spessore 40 mm disponibili in diverse finiture melaminiche e in molte colorazioni laccate. La pareti frontali e laterali sono divise in due fasce verticali giuntate tra loro che permettono creative combinazioni di tinta. Il top reception è disponibile in vetro retrolaccato con profilo in alluminio spazzolato lucido oppure in finitura legno.









In quanto autoportante, alla reception PHILO possono essere abbinate tutte le collezioni di tavoli Alea. I pannelli laterali sono dotati di profili dove agganciare accessori quali mensole, portacarte e portapenne. Il top reception può essere collocato in tre diverse posizioni: all'interno, a cavallo o all'esterno della paretina frontale.

As it is self-supporting, the PHILO reception counter can be matched with all Alea work desk collections. Side panels are equipped with profiles, where accessories can be attached, such as shelves, paper trays and pen holders. The reception top can be placed in three different positions: inside, across or outside the front wall.

Du moment qu'elle est autoporteuse, on peut associer à la banque d'accueil PHILO toutes les collections de plateaux Alea. Les panneaux latéraux sont dotés de profils sur lesquels on peut accrocher des accessoires comme des étagères, des range-dossiers et des porte-stylos. Le plateau supérieur peut être installé dans trois positions différentes par rapport au panneau avant: à l'intérieur, à cheval ou à l'extérieur.

Das selbsttragende Rezeptionspult PHILO lässt sich mit allen Tischkollektionen Alea kombinieren. Die seitlichen Paneele sind mit Profilen ausgestattet, in die Zubehörteile wie Borde, Aktenablagen und Stifthalter eingehakt werden können. Die Rezeptionsplatte kann in drei verschiedenen Positionen angebracht werden: auf der Innenseite, dazwischen liegend oder auf der Außenseite des vorderen Paneels.

Dado que es autoportante, el banco de recepción PHILO puede combinarse con todas las colecciones de mesas Alea. Los paneles laterales están dotados de perfiles para enganchar accesorios, como baldas, portapapeles y portabolígrafos. La encimera puede colocarse en tres posiciones distintas: dentro, sobrepuesta o fuera de la pared frontal.



















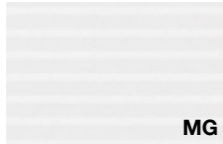



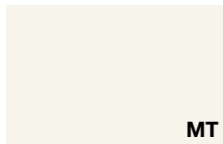



Finiture | Finishes | Finitions | Acabados

MEL

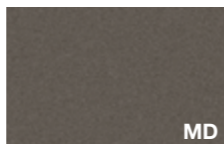
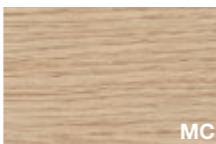
Melaminico

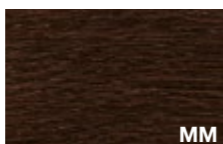
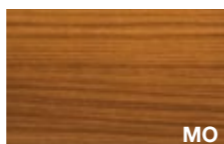
Melamine | Mélaminé | Melaminico

 Bianco rigato Rippled effect white Blanc avec rayures en sérigraphie Blanco rayado	 Grigio rigato Rippled effect grey Gris avec rayures en sérigraphie Gris rayado	 Nichel Nickel Nickel Niquel	 Cacao Cocoa Cacao Cacao	 Bianco White Blanc Blanco
 Talco Talco Talco Talco	 Ocra Ochre Ocre Ocre	 Terracotta Terracotta Terracotta Terracotta	 Safari Safari Safari Safari	 Noisette Noisette Noisette Noisette
 Verde Green Vert Verde	 Nero Black Noir Negro	 Blu notte Night blue Bleu nuit Azul noche	 Ardesia Ardesia Ardesia Pizarra	 Rovere chiaro Light oak Chêne clair Roble claro
 Rovere americano American oak Chêne américain Roble americano	 Rovere grigio Grey oak Chêne gris Roble gris	 Rovere moro Dark oak Chêne foncé Roble oscuro	 Noce Canaletto Canaletto Walnut Noyer Canaletto Nogal Canaletto	 Noce scuro Dark walnut Noyer foncé Nogal oscuro

Pannelli

Panels
Panneaux
PANELOS











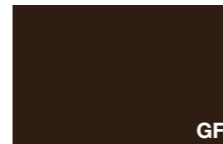
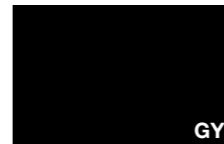

Mensola reception

Reception top
Support accueil
Estante mostrador

GOF

Goffrato

Embossed | Gaufré | Gofrado

 Bianco White Blanc Blanco	 Argento Silver Argent Plata	 Grigio scuro Dark grey Gris foncé Gris oscuro	 Noisette Noisette Noisette Noisette	 Ardesia Ardesia Ardesia Pizarra
 Moka Mocha Moka Cafe	 Nero Black Noir Negro	 Arancione Orange Orange Naranja	 Rosso "F" Red "F" Rouge "F" Rojo "F"	 Rubino Ruby Rubis Rubi
 Indaco Indigo Indigo Azul Indigo	 Azzurro Blue Bleu Azul	 Verde Green Vert Verde	 Cedro Lime green Vert Cédrot Verde Cedro	

Piani vetro

Glass tops
Plans en verre
Sobres en cristal

MTC

Metacrilato

Acrylic | Méthacrylate | Metacrilato

 Bianco opalino Opaline white Blanc opalin Blanco opaco	 Trasparente Transparent Transparent Transparente	 Rosso trasparente Red transparent Rouge transparent Rojo transparente	 Blu trasparente Blue transparent Bleu transparent Azul transparente	 Bianco satinato Satin-finish white Blanc satiné Blanco satinado
 Grigio fumè satinato Satin-finish smoky grey Gris satiné Gris satinado	 Arancione satinato Satin-finish orange Orange satiné Naranja satinado	 Blu satinato Satin-finish blue Bleu satiné Azul satinado	 Verde satinato Satin-finish green Vert satiné Verde satinado	

SCR

Ambiente e sicurezza | Environment and safety | Environnement et sécurité | Medio ambiente y seguridad

Ecologia: Alea utilizza per i suoi prodotti e i suoi imballi materiali facilmente separabili e riciclabili. (Immagine 1)

Catena Di Custodia COC: Alea si impegna ad utilizzare materiali legnosi certificati FSC® e pannelli a base di legno con certificazione CARB2.

I pannelli CARB2 presentano un rilascio di formaldeide inferiore rispetto al pannello E1 comunemente utilizzato (classe E1 secondo il DM 10/10/2008).

I prodotti certificati FSC® (License Code FSC-C118323) sono disponibili su richiesta: contattate i nostri uffici per maggiori informazioni. (Immagine 2)

LEED: Gli arredi di Alea possono contribuire al conseguimento del punteggio di certificazione LEED per i crediti indicati nei product badge. (Immagine 3)

Sistemi di Gestione certificati ISO 9001, ISO 14001, ISO 45001: Alea è attivamente impegnata nel raggiungere standard elevati di qualità e responsabilità attraverso l'adozione di sistemi di gestione certificati ISO per garantire prodotti e servizi di elevata qualità, in grado di soddisfare le aspettative dei clienti, di assicurare un ambiente di lavoro sicuro e di monitorare regolarmente l'impatto ambientale delle nostre attività. (Immagine 4)

Attestazione di prodotto: I prodotti Alea sono stati sottoposti a prove prestazionali presso laboratori di prova accreditati.

Copia dei rapporti di prova o delle attestazioni di conformità sono disponibili su richiesta. (Immagine 5)

Eco-friendly: Alea uses easily separable and recyclable materials for its products and packaging. (Image 1)

Chain of Custody (COC): Alea is committed to using FSC® certified wood materials and CARB2-certified wood-based panels. CARB2 panels have lower formaldehyde emissions compared to the commonly used E1 panels (class E1 according to the DM 10/10/2008). FSC® certified products (License Code FSC-C118323) are available upon request: please contact our offices for more information. (Image 2)

LEED: The A65 system can contribute to obtaining LEED certification points for the credits indicated in the product badges. (Image 3)

ISO 9001, ISO 14001, ISO 45001 Certified Management Systems: Alea is actively committed to achieving high standards of quality and responsibility through the adoption of ISO certified management systems to ensure high-quality products and services that meet customer expectations, provide a safe working environment, and regularly monitor the environmental impact of our activities. (Image 4)

Product Certification: Alea products have undergone performance tests by accredited testing laboratories. Copies of test reports or certificates of conformity are available upon request. (Image 5)



Ambiente e sicurezza | Environment and safety | Environnement et sécurité | Medio ambiente y seguridad

Écologie: Alea utilise pour ses produits et ses emballages des matériaux facilement séparables et recyclables. (Image 1)

Chaîne de contrôle COC: Alea a à cœur d'utiliser des matériaux en bois certifiés FSC® et des panneaux à base de bois avec la certification CARB2.

Les panneaux CARB2 présentent une émission de formaldéhyde inférieure à celle des panneaux E1 couramment utilisés (classe E1 selon le DM 10/10/2008). Les produits certifiés FSC® (Code de licence FSC-C118323) sont disponibles sur demande : veuillez contacter nos bureaux pour plus d'informations. (Image 2)

LEED: Le système A65 peut contribuer à l'obtention des points de certification LEED pour les crédits indiqués dans les badges produits. (Image 3)

Systèmes de gestion certifiés ISO 9001, ISO 14001, ISO 45001: Alea s'engage activement à atteindre des normes élevées de qualité et de responsabilité à travers l'adoption de systèmes de gestion certifiés ISO pour garantir des produits et services de haute qualité, répondre aux attentes des clients, assurer un environnement de travail sûr et surveiller régulièrement l'impact environnemental de nos activités. (Image 4)

Attestation de produit: Les produits Alea ont été soumis à des tests de performance dans des laboratoires d'essais accrédités. Des copies des rapports de tests ou des certificats de conformité sont disponibles sur demande. (Image 5)

Ecología: Alea utiliza para sus productos y embalajes materiales fácilmente separables y reciclables. (Imagen 1)

Cadena de Custodia COC: Alea se compromete a utilizar materiales de madera certificados por FSC® y paneles a base de madera con certificación CARB2.

Los paneles CARB2 presentan una emisión de formaldehído inferior en comparación con los paneles E1 comúnmente utilizados (clase E1 según el DM 10/10/2008). Los productos certificados por FSC® (Código de Licencia FSC-C118323) están disponibles bajo solicitud: por favor contacte a nuestras oficinas para más información. (Imagen 2)

LEED: El sistema A65 puede contribuir a la consecución de la puntuación de certificación LEED para los créditos indicados en los product badges. (Imagen 3)

Sistemas de Gestión Certificados ISO 9001, ISO 14001, ISO 45001: Alea está comprometida activamente en alcanzar altos estándares de calidad y responsabilidad mediante la adopción de sistemas de gestión certificados por ISO para garantizar productos y servicios de alta calidad, que cumplen con las expectativas de los clientes, aseguran un entorno de trabajo seguro y monitorean regularmente el impacto ambiental de nuestras actividades. (Imagen 4)

Certificación de Producto: Los productos Alea han sido sometidos a pruebas de rendimiento en laboratorios acreditados. Las copias de los informes de prueba o los certificados de conformidad están disponibles bajo solicitud. (Imagen 5)



Fianco laterale terminale H.105 - 6586

L. 50	9 11/16	Cod.0501051
L. 60	23 10/16	Cod.0601051
L. 70	27 9/16	Cod.0701051
L. 80	31 8/16	Cod.0801051
L. 90	35 7/16	Cod.0901051
L. 100	39 6/16	Cod.1001051
L. 110	43 5/16	Cod.1101051
L. 120	47 4/16	Cod.1201051
L. 130	51 3/16	Cod.1301051
L. 140	55 2/16	Cod.1401051
L. 150	59 1/16	Cod.1501051
L. 160	63	Cod.1601051
L. 170	66 15/16	Cod.1701051
L. 180	70 14/16	Cod.1801051
L. 190	74 13/16	Cod.1901051
L. 200	78 12/16	Cod.2001051
L. 210	82 11/16	Cod.2101051

Fianco laterale terminale H.105 - 6586

L. 50	9 11/16	Cod.0501052
L. 60	23 10/16	Cod.0601052
L. 70	27 9/16	Cod.0701052
L. 80	31 8/16	Cod.0801052
L. 90	35 7/16	Cod.0901052
L. 100	39 6/16	Cod.1001052
L. 110	43 5/16	Cod.1101052
L. 120	47 4/16	Cod.1201052
L. 130	51 3/16	Cod.1301052
L. 140	55 2/16	Cod.1401052
L. 150	59 1/16	Cod.1501052
L. 160	63	Cod.1601052
L. 170	66 15/16	Cod.1701052
L. 180	70 14/16	Cod.1801052
L. 190	74 13/16	Cod.1901052
L. 200	78 12/16	Cod.2001052
L. 210	82 11/16	Cod.2101052

Pannello frontale intermedio H.105 - 6587

L. 54	21 4/16	Cod.054105
L. 64	25 3/16	Cod.064105
L. 74	29 2/16	Cod.074105
L. 84	33 1/16	Cod.084105

Mensola H.105 - 6538

L. 50	19 11/16	Cod.05003 / V
L. 60	23 10/16	Cod.06003 / V
L. 70	27 9/16	Cod.07003 / V
L. 80	31 8/16	Cod.08003 / V
L. 90	35 7/16	Cod.09003 / V
L. 100	39 6/16	Cod.10003 / V
L. 110	43 5/16	Cod.11003 / V
L. 120	47 4/16	Cod.12003 / V
L. 130	51 3/16	Cod.13003 / V
L. 140	55 2/16	Cod.14003 / V
L. 150	59 1/16	Cod.15003 / V
L. 160	63	Cod.16003 / V
L. 170	66 15/16	Cod.17003 / V
L. 180	70 14/16	Cod.18003 / V
L. 190	74 13/16	Cod.19003 / V
L. 200	78 12/16	Cod.20003 / V
L. 210	82 11/16	Cod.21003 / V

Fianco per angolo 90° H.105 - 6585

L. 34	13 6/16	Cod.0341052
-------	---------	-------------

Pannello frontale terminale H.105 - 6585

L. 50	19 11/16	Cod.0501051
L. 60	23 10/16	Cod.0601051
L. 70	27 9/16	Cod.0701051
L. 80	31 8/16	Cod.0801051
L. 90	35 7/16	Cod.0901051
L. 100	39 6/16	Cod.1001051
L. 110	43 5/16	Cod.1101051
L. 120	47 4/16	Cod.1201051
L. 130	51 3/16	Cod.1301051
L. 140	55 2/16	Cod.1401051
L. 150	59 1/16	Cod.1501051
L. 160	63	Cod.1601051
L. 170	66 15/16	Cod.1701051
L. 180	70 14/16	Cod.1801051
L. 190	74 13/16	Cod.1901051
L. 200	78 12/16	Cod.2001051
L. 210	82 11/16	Cod.2101051

Pannello frontale intermedio H.105 - 6585

L. 50	19 11/16	Cod.0501052
L. 60	23 10/16	Cod.0601052
L. 70	27 9/16	Cod.0701052
L. 80	31 8/16	Cod.0801052
L. 90	35 7/16	Cod.0901052
L. 100	39 6/16	Cod.1001052
L. 110	43 5/16	Cod.1101052
L. 120	47 4/16	Cod.1201052
L. 130	51 3/16	Cod.1301052
L. 140	55 2/16	Cod.1401052
L. 150	59 1/16	Cod.1501052
L. 160	63	Cod.1601052
L. 170	66 15/16	Cod.1701052
L. 180	70 14/16	Cod.1801052
L. 190	74 13/16	Cod.1901052
L. 200	78 12/16	Cod.2001052
L. 210	82 11/16	Cod.2101052

Pannello frontale terminale H.105 - 6585

L. 34	13 6/16	Cod.0341051
-------	---------	-------------

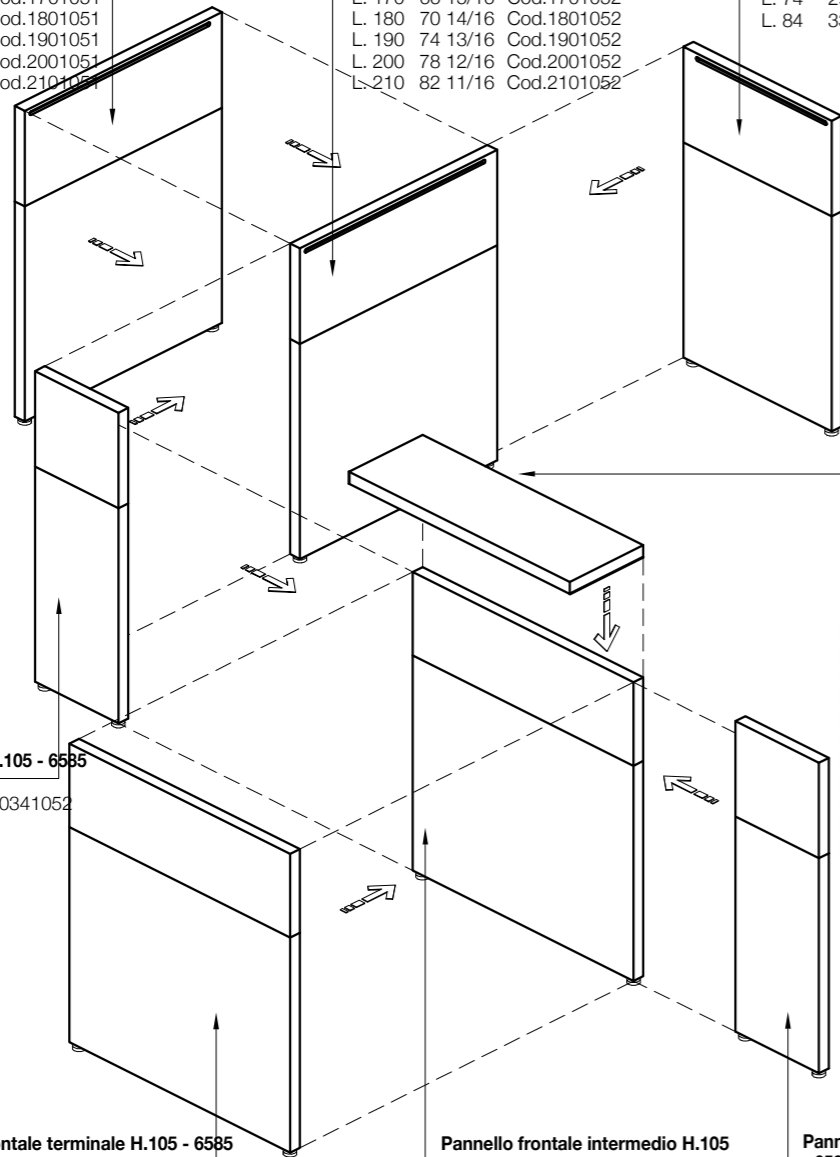

concept & graphic design
Allea marketing + communication

design
Filippon & Mirto Antonel

art direction
Mirto Antonel

AF/CACB/AB



GLOBAL HEADQUARTERS AND SHOWROOM : Via Col de Rust, 19 - 33070 Sarone (PN) - Italia : Tel ++39 0434 777 333
email: info@aleaoffice.com **PARIS SHOWROOM** : 176 Avenue Charles de Gaulle 92200, Neuilly-sur-Seine - France **NORTH AMERICAN
HEADQUARTERS** : Midtown 2, 3449 NE 1st Avenue L-32, Miami, FL 33137 - USA : Tel ++1 305 470 1200 - email: info@alea-usa.com
ALEA UK OFFICE AND SHOWROOM : 50-54 Clerkenwell Road, London EC1M 5PS - email: info@aleaoffice.com