

# alea

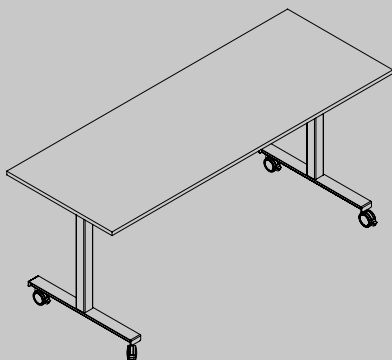

CLUB

---

complementi | complements | compléments | complementos

“ Vi presentiamo Club:  
il nostro tavolo ribaltabile  
multifunzionale ”

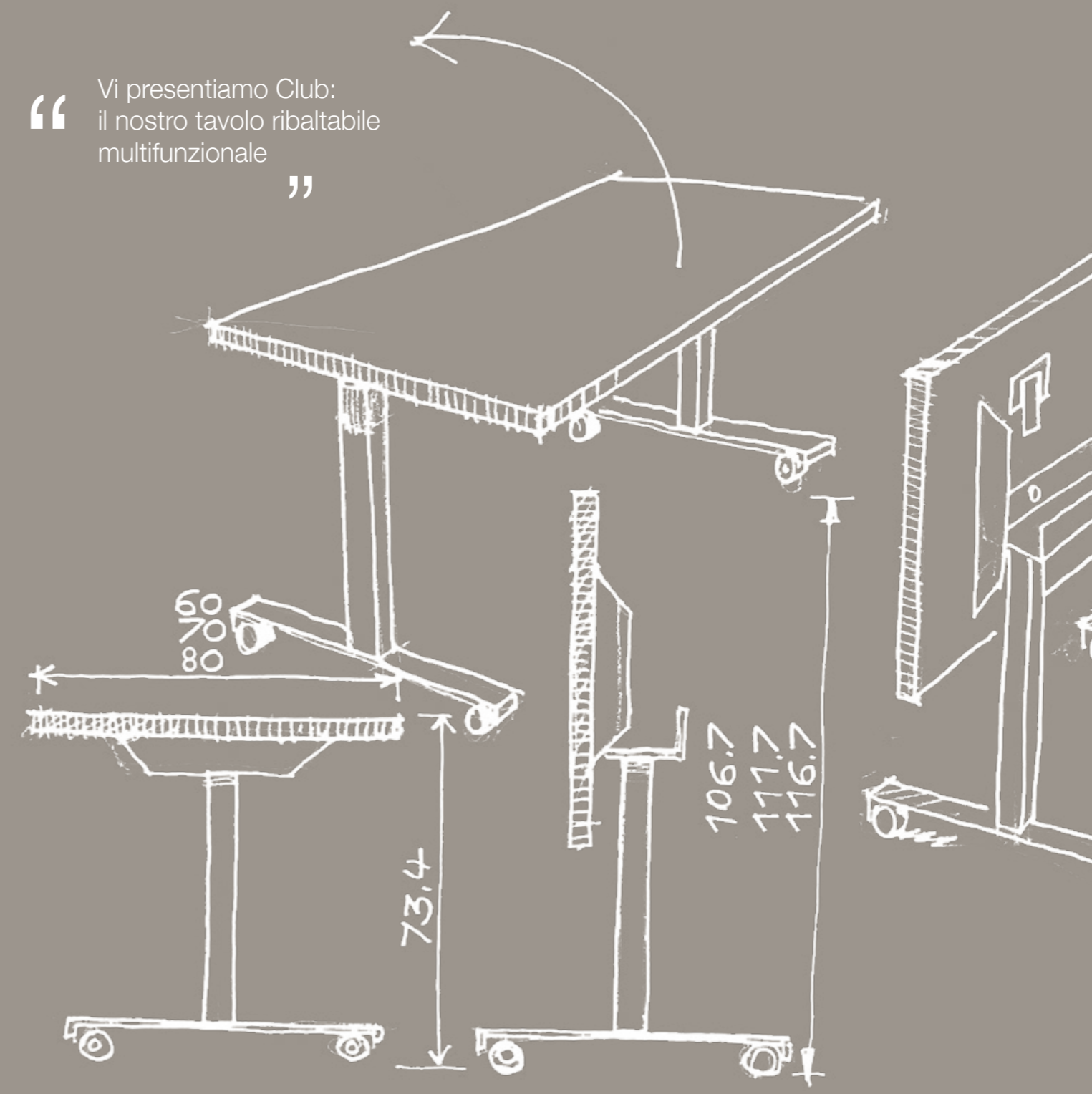

*Introducing Club:  
our multifunctional folding table*

*Nous vous présentons Club:  
la table rabattable multifonctionnelle*

*Les presentamos Club:  
nuestra mesa plegable multifuncional*



Il tavolo Club con piano ribaltabile e struttura su ruote, è adatto ad arredare sale polifunzionali. Si compone di una struttura in alluminio estruso a sezione quadrata e piedi in lamiera d'acciaio, entrambi verniciati a polveri epossidiche in molteplici colori, e un top realizzato in melaminico spessore 30 mm. I tavoli possono essere facilmente spostati, piegati e stoccati quando necessario.

*Club is a folding table on casters with many applications. It consists of an extruded aluminium structure with square section and steel feet, both painted with epoxy powder in many colours, and a top made of 30 mm (1 3/16") thick Italian melamine panel. Tables can be easily moved, folded and stored when needed.*

*La table Club avec plateau rabattable et mobile, s'adapte a' plusieurs configurations et solutions et convient aux salles polyvalentes. Sa structure en aluminium extrudé avec une section carrée et les pieds en tôle d'acier sont disponibles en finition époxy laqué en plusieurs couleurs. Son plateau en mélamine de 30 mm d'épaisseur a autant de finitions possibles. Ces table peuvent être facilement déplacés, pliées et stockées au besoin.*

*La mesa Club con el sobre plegable y la estructura sobre ruedas, es adecuada para salas polivalentes. Se compone de una estructura en aluminio extruido de sección cuadrada y pies en chapa de acero, ambos barnizados con polvos epoxi en varios colores, y un sobre superior realizado en melamina de 30 mm de espesor. Las mesas se pueden mover fácilmente, plegar y almacenar cuando sea necesario.*

La parte delle ruote a contatto con il pavimento è in gomma. L'appoggio a terra consente un'ottima stabilità, adatta a qualsiasi tipo di pavimentazione, anche in tessuto, rispettando interamente le superfici. Le ruote montate dal lato operatore sono provviste di freno.



*The part of the wheel in contact with the floor is made of rubber. The part that leans on the ground allows for excellent stability, suitable for any type of flooring including carpet, without ruining the floor. The wheels mounted on the operator side have a brake.*

*Les roulettes sont revêtus en caoutchouc. L'appui au sol permet une excellente stabilité, adapté à tout type de revêtement de sol, même en tissu, en respectant entièrement les surfaces. Les roues cote' operateur sont munies de frein.*

*La parte de las ruedas que lleva en contacto con el suelo está hecho de caucho. La parte que apoya en el suelo permite una excelente estabilidad, adecuado para cualquier tipo de suelo, incluso textil, respetando por completo las superficies. Las ruedas montadas en el lado del operador están equipadas con un freno.*

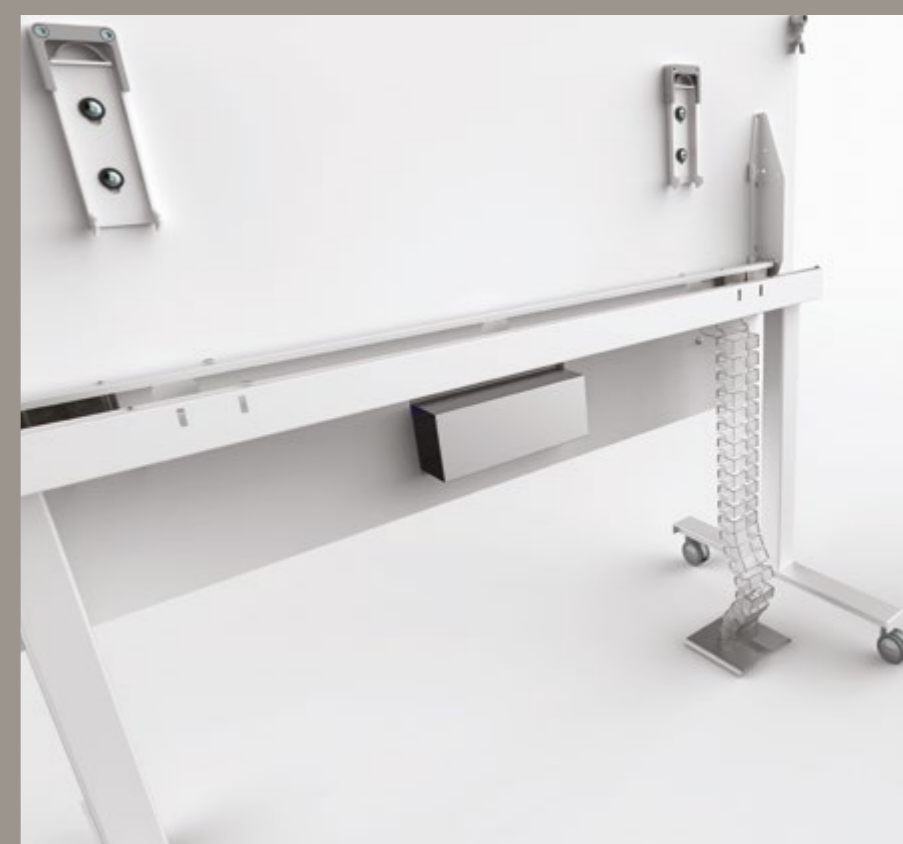
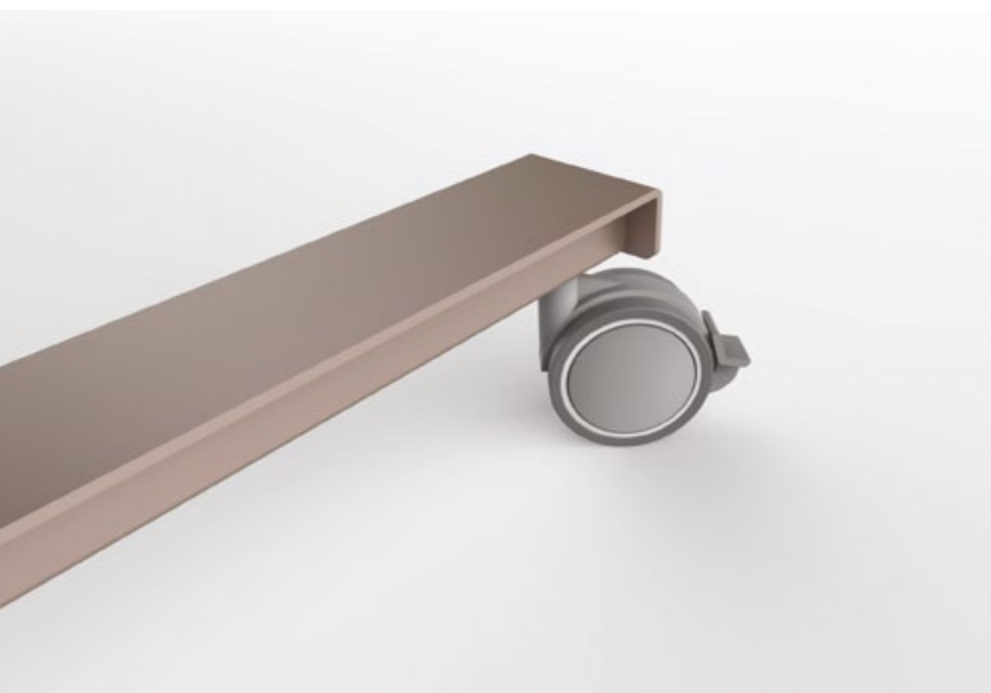

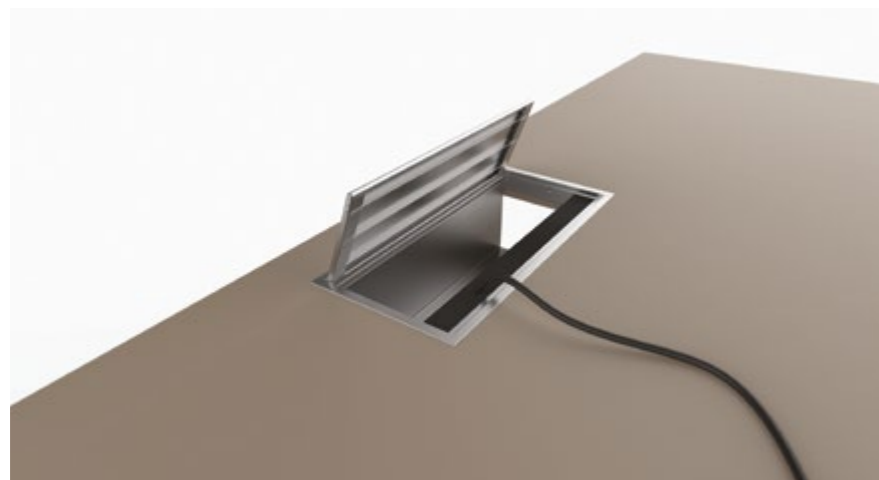

*Ganging devices are used to connect the tables. The kit consists of two pairs of plastic parts installed below the worksurface with metric screws. Club tables can be equipped with PVC grommets of different sizes. When the table has a flip top, the door is in aluminum and carries a magnet to prevent it from opening when the table is placed in "parking" position. For the electrification it is possible to use the structural beam which also acts as a cable carrier. Vertical electrification can be made with translucent polycarbonate vertebrae secured to the desk top or to the beam.*

*Pour connecter les tables en ligne les uns avec les autres des crochets en plastique sont appliqués à la partie supérieure; ceux-ci sont fixés sous la table de travail avec de vis métriques. Les tables Club peuvent être équipées des passe câbles en PVC de différentes tailles et des tops accès modulaires en aluminium avec aimant pour éviter que ceux-ci ouvrent lorsque la table est placée en position "park". Pour l'électrification, il est possible d'utiliser la poutre structurelle qui agit également comme passage des câbles en horizontal. L'électrification verticale peut être réalisée avec les vertèbres en polycarbonate translucide fixées au sol et à la poutre.*

Per collegare in linea i tavoli tra loro vengono applicati al top degli appositi ganci realizzati in plastica che si fissano sotto al piano di lavoro tramite viti metriche. I tavoli Club possono essere dotati di passacavi in PVC di varie dimensioni e di top access modulari realizzati in alluminio con magnete di chiusura applicato allo sportello per evitare che questo si apra quando il tavolo viene posto in posizione di "parcheggio". Per l'elettrificazione è possibile sfruttare la trave strutturale che funge anche da portacavi. L'elettrificazione verticale può essere invece realizzata con vertebre in polycarbonato traslucido fissate ai piani o alla trave.

*Para unir las mesas entre ellas en línea, se utilizan un par de ganchos de plástico que se fijan debajo de la mesa de trabajo a través de tornillos métricos. Todas las mesas Club pueden equiparse con pasacables en PVC de varios tamaños y de top access modulares realizados en aluminio con cierre magnético aplicado a la tapeta abatible para evitar que esta se abra cuando la mesa se coloca en la posición "aparcamiento". Para la electrificación es posible utilizar la viga estructural que permite también el pasaje de los cables. En cambio, la electrificación vertical puede realizarse con vértebras de polycarbonato translúcido fijadas al sobre de mesa o a la viga.*

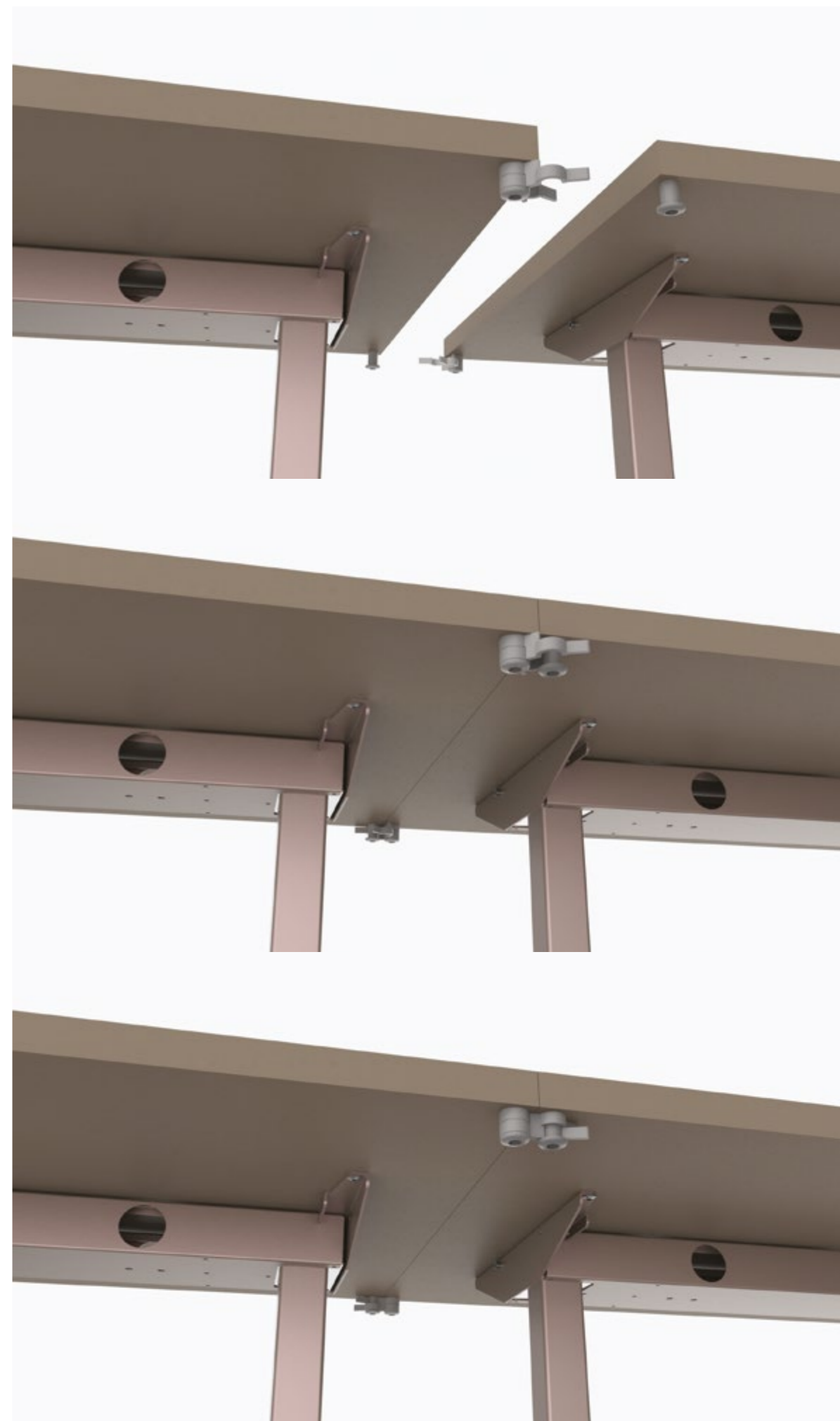

La struttura della scrivania è composta da due colonne verticali in alluminio estruso a sezione quadrata 50x50 mm, spessore 2 mm, con piedi in lamiera d'acciaio presso-piegata dello spessore 3 mm e trave strutturale in lamiera d'acciaio spessore 1,5 mm. La trave, che serve anche da canale portacavi, viene fissata alle colonne tramite dei giunti realizzati in pressofusione di zama mentre il piano è fissato alla struttura tramite staffe in lamiera d'acciaio presso-piegata dello spessore di 3 mm. La struttura è disponibile in vari colori epossidici. Le ruote, fissate ai piedi del tavolo, hanno un diametro di 60 mm ed una portata di 35 Kg ognuna.

*The desk structure consists of two vertical extruded aluminum columns with a square section of 50x50 mm (2"x2"), 2 mm (1/16") thick, with steel feet 3 mm (2/16") thick and 1,5 mm (3/32") thick steel structure. The beam, which also serves as a wire channel, is secured to the columns via zamac die-casting joints while the desk top is fastened to the structure with 3 mm (2/16") thick steel brackets. The structure is available in various epoxy colors. The wheels have a diameter of 60 mm (2 6/16") and a weight limit of 35 Kg (77 lbs) each.*



*La structure de la table se compose de deux colonnes verticales d'aluminium extrudé avec une section carrée 50x50 mm, épaisseur 2 mm, avec des pieds en tôle d'acier pliée d'une épaisseur de 3 mm et une poutre de structure de tôle d'acier de 1,5 mm d'épaisseur. La poutre, qui sert aussi de passage des câbles, est fixé sur les pieds par de joints en zamak. Le plateau en revanche est fixé à la structure par des équerres en tôle d'acier, épaisseur de 3 mm. La structure est disponible en différentes couleurs époxy. Les roues, fixées au pied de la table, ont un diamètre de 60 mm et une capacité de 35 kg chacune.*

*La estructura de la mesa está compuesta por dos columnas verticales en aluminio extruido de sección cuadrada de 50x50 mm, espesor 2 mm, con los pies en chapa de acero plegada de 3 mm de espesor y una viga estructural en chapa de acero de 1,5 mm de espesor. La viga estructural que permite también el pasaje de los cables, se fija a las columnas por medio de articulaciones hechas de zinc, mientras que el sobre de mesa se fija a la estructura por medio de soportes en chapa de acero plegada de 3 mm de espesor. El marco está disponible en diferentes colores epoxi. Las ruedas, fijadas a los pies de la mesa, tienen un diámetro de 60 mm y una capacidad de 35 kg cada una.*



Il modesty è realizzato in agglomerato ligneo spessore 18 mm nobilitato melaminico, con bordi perimetrali in ABS spessore 1 mm. Le staffe di supporto sono realizzate in lamiera d'acciaio e verniciate dello stesso colore della struttura e permettono la rotazione del modesty stesso quando il piano viene messo in posizione di "parcheggio".

*Modesty panel is made of 18 mm (11/16") thick melamine-faced particle board, edged in 1 mm (1/32") ABS. The support brackets are made of steel and painted with the same finish as the structure and allow the modesty rotation when the desk top is in "parking" position.*

*Le voile de fond est réalisé en mélaminé épaisseur 18 mm, avec un chant en pvc épaisseur 1 mm. Les équerres sont en tôle d'acier, peint de la même couleur de la structure et permettent la rotation du voile de fond lorsque le plan est mis en position "park".*

*Faldón realizado en aglomerado de madera de 18 mm de espesor, con borde en ABS de 1 mm. Los soportes están hechos en chapa de acero y pintadas del mismo color de la estructura y permiten la rotación del faldón cuando el sobre de mesa se pone en posición de "aparcamiento".*





**/configurazione a U** | U configuration  
configuration U | configuración de U



**/configurazione a V** | V configuration  
configuration V | configuración de V

**Modulo elettrificato sul piano**  
*Top power module*  
*Module électrifié sur le plan de travail*  
*Módulo electrificado en sobre mesa*

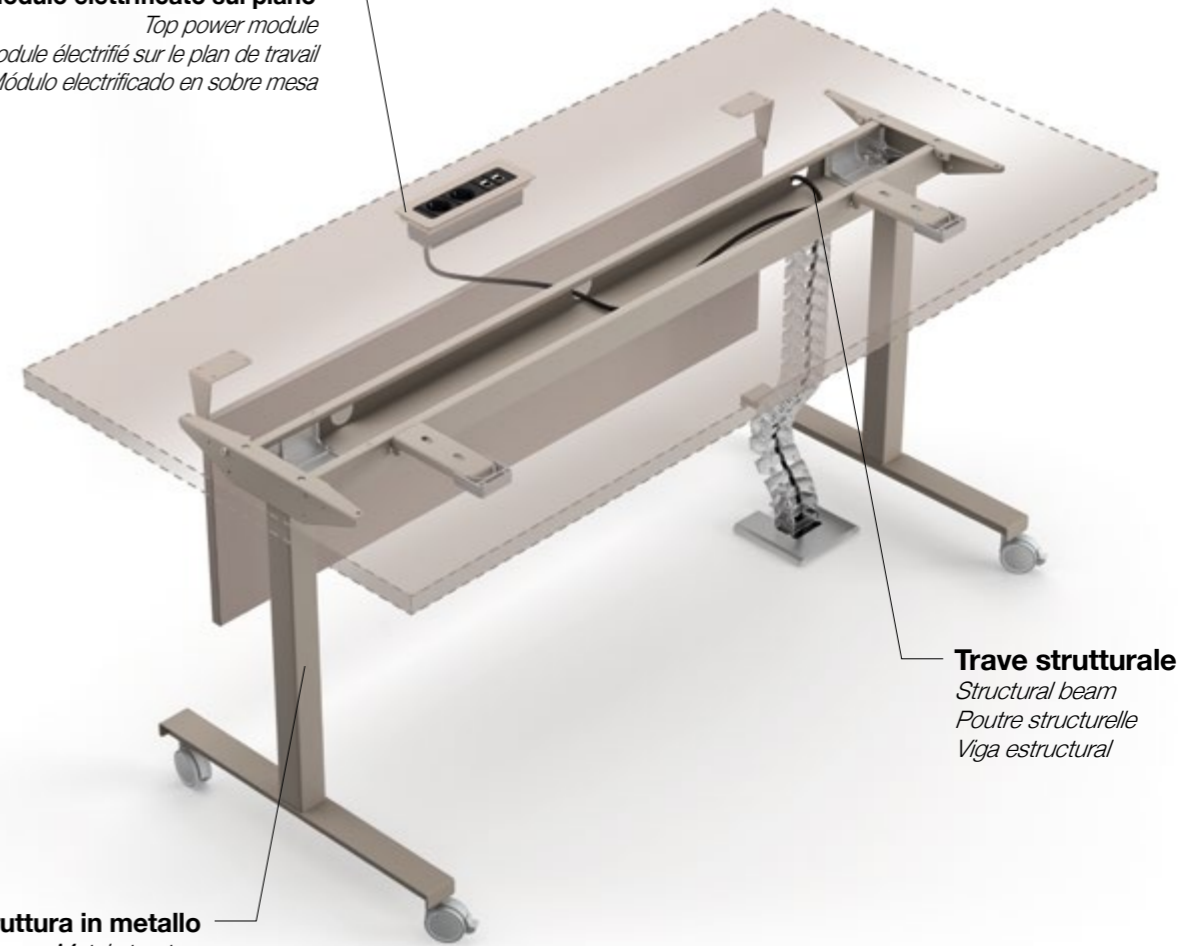

**Trave strutturale**  
*Structural beam*  
*Poutre structurelle*  
*Viga estructural*

**Struttura in metallo**  
*Metal structure*  
*Structure en métal*  
*Estructura metálica*

**Scrivania singola** | *single desk* | *bureau individuel* | *mesa individual*

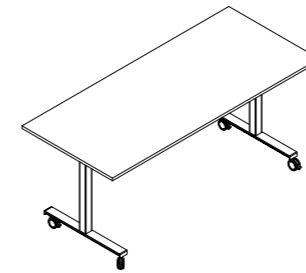

|                          | <b>L 1200</b><br>47 4/16" | <b>L 1400</b><br>55 2/16" | <b>L 1600</b><br>63" | <b>L 1800</b><br>70 14/16" |  |  |
|--------------------------|---------------------------|---------------------------|----------------------|----------------------------|--|--|
| <b>P 600</b>   23 10/16" | •                         | •                         | •                    | •                          |  |  |
| <b>P 700</b>   27 9/16"  | •                         | •                         | •                    | •                          |  |  |
| <b>P 800</b>   31 8/16"  | •                         | •                         | •                    | •                          |  |  |













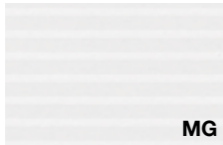



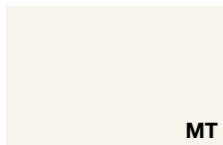



# Finiture | Finishes | Finitions | Acabados

## MEL

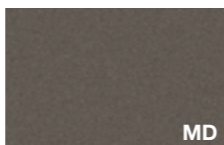
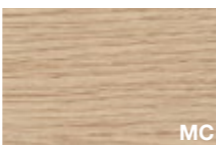
### Melaminico

Melamine | Mélaminé | Melaminico

TOP





|   |   |   |  |   |
|---|---|---|--|---|
| <br><b>Bianco rigato</b><br>Rippled effect white<br>Blanc avec rayures en sérigraphie<br>Blanco rayado | <br><b>Grigio rigato</b><br>Rippled effect grey<br>Gris avec rayures en sérigraphie<br>Gris rayado | <br><b>Nichel</b><br>Nickel<br>Nickel<br>Niquel                    | <br><b>Cacao</b><br>Cocoa<br>Cacao<br>Cacao  | <br><b>Bianco</b><br>White<br>Blanc<br>Blanco                        |
| <br><b>Talco</b><br>Talco<br>Talco<br>Talco  | <br><b>Ocra</b><br>Ochre<br>Ocre<br>Ocre   | <br><b>Terracotta</b><br>Terracotta<br>Terracotta<br>Terracota     | <br><b>Safari</b><br>Safari<br>Safari<br>Safari                                      | <br><b>Noisette</b><br>Noisette<br>Noisette<br>Noisette              |
| <br><b>Verde</b><br>Green<br>Vert<br>Verde   | <br><b>Nero</b><br>Black<br>Noir<br>Negro  | <br><b>Blu notte</b><br>Night blue<br>Bleu nuit<br>Azul noche      | <br><b>Ardesia</b><br>Ardesia<br>Ardesia<br>Pizarra                                  | <br><b>Rovere chiaro</b><br>Light oak<br>Chêne clair<br>Roble claro  |
| <br><b>Rovere americano</b><br>American oak<br>Chêne américain<br>Roble americano                     | <br><b>Rovere grigio</b><br>Grey oak<br>Chêne gris<br>Roble gris                                  | <br><b>Rovere moro</b><br>Dark oak<br>Chêne foncé<br>Roble oscuro | <br><b>Noce Canaletto</b><br>Canaletto Walnut<br>Noyer Canaletto<br>Nogal Canaletto | <br><b>Noce scuro</b><br>Dark walnut<br>Noyer foncé<br>Nogal oscuro |

## LGN

### Legno

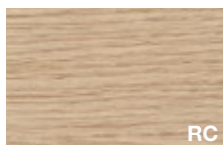
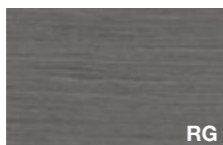
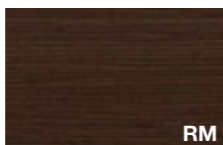
Wood | Bois | Madera

TOP

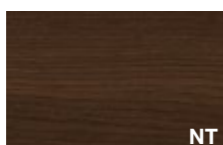
|  |   |  |   |   |
|--|---|--|---|---|
| <br><b>Rovere chiaro</b><br>Light oak<br>Chêne clair<br>Roble claro             | <br><b>Rovere grigio fumo</b><br>Smoke grey oak<br>Chêne gris de fumée<br>Roble gris humo      | <br><b>Rovere moro</b><br>Dark oak<br>Chêne foncé<br>Roble oscuro | <br><b>Noce Canaletto</b><br>Canaletto walnut<br>Noyer Canaletto<br>Nogal Canaletto | <br><b>Ebano silver</b><br>Silver ebony<br>Ebony silver<br>Ebano plata |
| <br><b>Ebano Makassar</b><br>Makassar ebony<br>Ebony Makassar<br>Ebano Makassar | <br><b>Noce termocotto</b><br>Heat-treated walnut<br>Noyer thermo traité<br>Nogal termotratado |  |   |   |

## EPX

### Epossidico

Epoxy | Époxy | Epoxi

STRU

|  |  |   |   |  |
|--|--|---|---|--|
| <br><b>Bianco</b><br>White<br>Blanc<br>Blanco                 | <br><b>Talco</b><br>Talco<br>Talco<br>Talco                       | <br><b>Grigio</b><br>Grey<br>Gris<br>Gris                      | <br><b>Beige Arizona</b><br>Arizona beige<br>Beige Arizona<br>Beige Arizona    | <br><b>Noisette</b><br>Noisette<br>Noisette<br>Noisette |
| <br><b>Safari</b><br>Safari<br>Safari<br>Safari               | <br><b>Rame</b><br>Copper<br>Cuivre<br>Cobre                      | <br><b>Terracotta</b><br>Terracotta<br>Terracotta<br>Terracota | <br><b>Rosso Jaipur</b><br>Jaipur red<br>Rouge Jaipur<br>Rojo Jaipur           | <br><b>Bronzo</b><br>Bronze<br>Bronze<br>Bronce         |
| <br><b>Blu notte</b><br>Night blue<br>Bleu nuit<br>Azul noche | <br><b>Grigio Bromo</b><br>Bromo grey<br>Gris Bromo<br>Gris Bromo | <br><b>Ardesia</b><br>Ardesia<br>Ardesia<br>Pizarra            | <br><b>Verde Comodoro</b><br>Comodoro green<br>Vert Comodoro<br>Verde Comodoro | <br><b>Nero</b><br>Black<br>Noir<br>Negro               |

### Applicazioni finiture

Finish application | Application finitions | Aplicacion acabados

TOP  
Top  
Piano  
Plateau  
Sobre

STRU  
Struttura  
Structure  
Structure

Le finiture contenute nella stampa sono puramente indicative e non sono di riferimento per le finiture del prodotto  
Due to the printing process, finishes shown in this document are for illustration only. The finish on the final item may differ slightly from the printed illustration  
Les finitions contenues dans l'impression sont purement indicatives et ne sont pas pertinentes pour les finitions du produit  
Los acabados contenidos en la impresión son puramente indicativos y no son de referencia para los suministros del producto

# Ambiente e sicurezza | Environment and safety | Environnement et sécurité | Medio ambiente y seguridad

**Ecologia:** Alea utilizza per i suoi prodotti e i suoi imballi materiali facilmente separabili e riciclabili. (Immagine 1)

**Catena Di Custodia COC:** Alea si impegna ad utilizzare materiali legnosi certificati FSC® e pannelli a base di legno con certificazione CARB2.

I pannelli CARB2 presentano un rilascio di formaldeide inferiore rispetto al pannello E1 comunemente utilizzato (classe E1 secondo il DM 10/10/2008).

I prodotti certificati FSC® (License Code FSC-C118323) sono disponibili su richiesta: contattate i nostri uffici per maggiori informazioni. (Immagine 2)

**LEED:** Gli arredi di Alea possono contribuire al conseguimento del punteggio di certificazione LEED per i crediti indicati nei product badge. (Immagine 3)

**Sistemi di Gestione certificati ISO 9001, ISO 14001, ISO 45001:** Alea è attivamente impegnata nel raggiungere standard elevati di qualità e responsabilità attraverso l'adozione di sistemi di gestione certificati ISO per garantire prodotti e servizi di elevata qualità, in grado di soddisfare le aspettative dei clienti, di assicurare un ambiente di lavoro sicuro e di monitorare regolarmente l'impatto ambientale delle nostre attività. (Immagine 4)

**Attestazione di prodotto:** I prodotti Alea sono stati sottoposti a prove prestazionali presso laboratori di prova accreditati.

Copia dei rapporti di prova o delle attestazioni di conformità sono disponibili su richiesta. (Immagine 5)

**Eco-friendly:** Alea uses easily separable and recyclable materials for its products and packaging. (Image 1)

**Chain of Custody (COC):** Alea is committed to using FSC® certified wood materials and CARB2-certified wood-based panels. CARB2 panels have lower formaldehyde emissions compared to the commonly used E1 panels (class E1 according to the DM 10/10/2008). FSC® certified products (License Code FSC-C118323) are available upon request: please contact our offices for more information. (Image 2)

**LEED:** The A65 system can contribute to obtaining LEED certification points for the credits indicated in the product badges. (Image 3)

**ISO 9001, ISO 14001, ISO 45001 Certified Management Systems:** Alea is actively committed to achieving high standards of quality and responsibility through the adoption of ISO certified management systems to ensure high-quality products and services that meet customer expectations, provide a safe working environment, and regularly monitor the environmental impact of our activities. (Image 4)

**Product Certification:** Alea products have undergone performance tests by accredited testing laboratories. Copies of test reports or certificates of conformity are available upon request. (Image 5)



# Ambiente e sicurezza | Environment and safety | Environnement et sécurité | Medio ambiente y seguridad

**Écologie:** Alea utilise pour ses produits et ses emballages des matériaux facilement séparables et recyclables. (Image 1)

**Chaîne de contrôle COC:** Alea a à cœur d'utiliser des matériaux en bois certifiés FSC® et des panneaux à base de bois avec la certification CARB2.

Les panneaux CARB2 présentent une émission de formaldéhyde inférieure à celle des panneaux E1 couramment utilisés (classe E1 selon le DM 10/10/2008). Les produits certifiés FSC® (Code de licence FSC-C118323) sont disponibles sur demande : veuillez contacter nos bureaux pour plus d'informations. (Image 2)

**LEED:** Le système A65 peut contribuer à l'obtention des points de certification LEED pour les crédits indiqués dans les badges produits. (Image 3)

**Systèmes de gestion certifiés ISO 9001, ISO 14001, ISO 45001:** Alea s'engage activement à atteindre des normes élevées de qualité et de responsabilité à travers l'adoption de systèmes de gestion certifiés ISO pour garantir des produits et services de haute qualité, répondre aux attentes des clients, assurer un environnement de travail sûr et surveiller régulièrement l'impact environnemental de nos activités. (Image 4)

**Attestation de produit:** Les produits Alea ont été soumis à des tests de performance dans des laboratoires d'essais accrédités. Des copies des rapports de tests ou des certificats de conformité sont disponibles sur demande. (Image 5)

**Ecología:** Alea utiliza para sus productos y embalajes materiales fácilmente separables y reciclables. (Imagen 1)

**Cadena de Custodia COC:** Alea se compromete a utilizar materiales de madera certificados por FSC® y paneles a base de madera con certificación CARB2.

Los paneles CARB2 presentan una emisión de formaldehído inferior en comparación con los paneles E1 comúnmente utilizados (clase E1 según el DM 10/10/2008). Los productos certificados por FSC® (Código de Licencia FSC-C118323) están disponibles bajo solicitud: por favor contacte a nuestras oficinas para más información. (Imagen 2)

**LEED:** El sistema A65 puede contribuir a la consecución de la puntuación de certificación LEED para los créditos indicados en los product badges. (Imagen 3)

**Sistemas de Gestión Certificados ISO 9001, ISO 14001, ISO 45001:** Alea está comprometida activamente en alcanzar altos estándares de calidad y responsabilidad mediante la adopción de sistemas de gestión certificados por ISO para garantizar productos y servicios de alta calidad, que cumplen con las expectativas de los clientes, aseguran un entorno de trabajo seguro y monitorean regularmente el impacto ambiental de nuestras actividades. (Imagen 4)

**Certificación de Producto:** Los productos Alea han sido sometidos a pruebas de rendimiento en laboratorios acreditados. Las copias de los informes de prueba o los certificados de conformidad están disponibles bajo solicitud. (Imagen 5)



**Concept, visual & graphic design**

Alea marketing + communication

**Design**

Mirto Antonel

**Art direction**

Mirto Antonel

**Si ringrazia M.artedesign**

[martedesign.it](http://martedesign.it)

AH/CABH/AA



**GLOBAL HEADQUARTERS AND SHOWROOM** : Via Col de Rust, 19 - 33070 Sarone (PN) - Italia : Tel ++39 0434 777 333  
email: info@aleaoffice.com **PARIS SHOWROOM** : 176 Avenue Charles de Gaulle 92200, Neuilly-sur-Seine - France **NORTH AMERICAN  
HEADQUARTERS** : Midtown 2, 3449 NE 1st Avenue L-32, Miami, FL 33137 - USA : Tel ++1 305 470 1200 - email: info@alea-usa.com  
**ALEA UK OFFICE AND SHOWROOM** : 50-54 Clerkenwell Road, London EC1M 5PS - email: info@aleaoffice.com