

alea

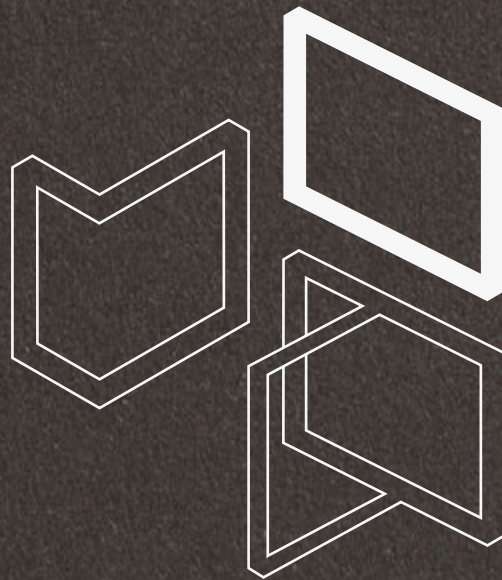

Archimede

executive

Linearità

Archimede si distingue per il suo design lineare e leggero, adatto ad ambienti manageriali dal tocco moderno.

Archimede stands out for its linear and light design, suitable for managerial environments with a modern touch.

Archimede se distingue par son design linéaire et léger, adapté aux environnements managériaux avec une touche linéaire.

Archimede destaca por su diseño lineal y ligero, adecuado para entornos directivos con un toque moderno.

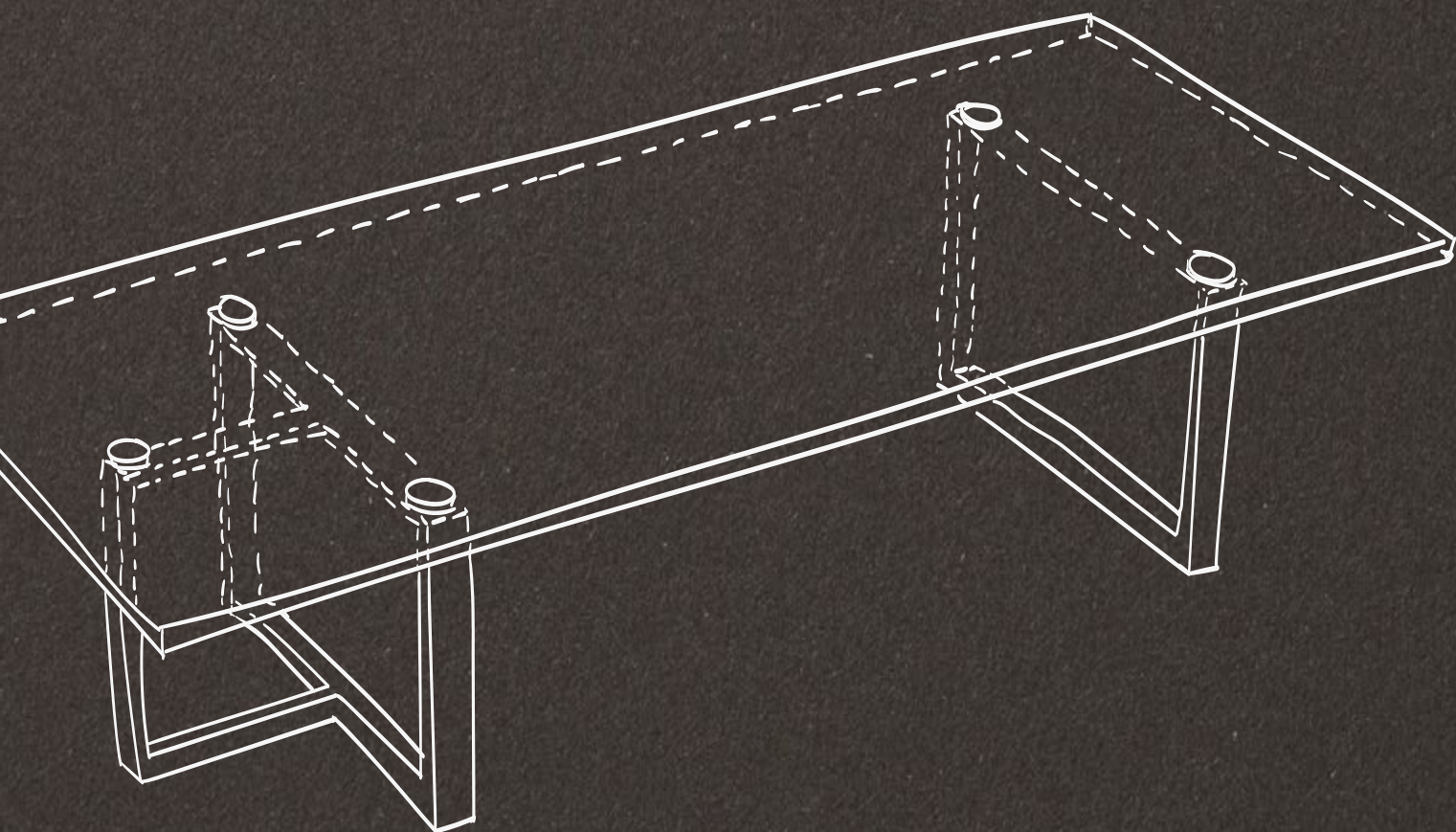



Geometria

La struttura di Archimede è caratterizzata da gambe in metallo verniciato o in acciaio inox, che presentano tre opzioni di design (ad anello, a T e ad L) che si possono mescolare tra loro.

Geometry Archimede's structure is characterised by painted metal or stainless steel legs with three design options (ring, T-shaped and L-shaped) that can be mixed and matched.

Géométrie La structure d'Archimede est caractérisée par des pieds en métal peint ou en acier inoxydable, avec trois options de design (en anneau, en T et en L) qui peuvent être mélangées et assorties.

Geometría La estructura de Archimede se caracteriza por patas de metal pintado o acero inoxidable con tres opciones de diseño (en forma de anillo, en forma de T y en forma de L) que pueden mezclarse y combinarse.





Scrivania | Desk | Bureau | Mesa **Fin.** NO, EE
L 240 P 120 cm | W 94 1/2" D 47 1/4"



Scrivania | Desk | Bureau | Mesa **Fin.** GY NFG, EN
L 150 P 150 cm | W 59" D 59"
Mobile di servizio | Service unit | Meuble retour | Mueble de servicio **Fin.** AK, EN
L 200 P 60 cm | W 78 3/4" D 23 5/8"



Look

Archimede diventa elemento architettonico. I volumi e le forme si integrano perfettamente nello spazio circostante, creando un look elegante e contemporaneo.

Look Archimede becomes an architectural element. Volumes and shapes blend perfectly into the surrounding space, creating an elegant and contemporary look.

Look Archimede devient un élément architectural. Les volumes et les formes s'intègrent parfaitement à l'espace environnant, créant un look élégant et contemporain.

Look Archimede se convierte en un elemento arquitectónico. Los volúmenes y las formas se integran perfectamente en el espacio circundante, creando un aspecto elegante y contemporáneo.





Scrivania | Desk | Bureau | Mesa **Fin.** MT, ET
L 240 **P** 90 cm | **W** 94 **1/2"** **D** 35 **3/8"**
Mobile di servizio | Service unit | Meuble retour | Mueble de servicio **Fin.** MT, ET
L 240 **P** 60 cm | **W** 94 **1/2"** **D** 23 **5/8"**

Organizzazione

La scrivania si può appoggiare al contenitore laterale, dotato di cassetti e vani chiusi da ante scorrevoli. Questo elemento è perfetto per organizzare lo spazio di lavoro mantenendo il massimo ordine.



Organising The desk can be supported by the lateral storage unit, which is equipped with drawers and compartments closed by sliding doors. This element is perfect for organising the work space while maintaining maximum tidiness.

Organisation Le bureau peut être placé sur le meuble de rangement latéral, qui est équipé de tiroirs et de compartiments fermés par des portes coulissantes. Cet élément est parfait pour organiser l'espace de travail tout en maintenant un ordre maximal.



Organización El escritorio puede colocarse sobre el mueble de almacenamiento lateral, equipado con cajones y compartimentos cerrados por puertas correderas. Este elemento es perfecto para organizar el espacio de trabajo manteniendo el máximo orden.





Scrivanìa | Desk | Bureau | Mesa **Fin.** MM, EI
 L 240 P 90 cm | W 94 1/2" D 35 3/8"
Mobile di servizio | Service unit | Meuble retour | Mueble de servicio **Fin.** MD, EI
 L 240 P 90 cm | W 94 1/2" D 35 3/8"

Il contenitore laterale è disponibile in due profondità, 60 o 90 cm. La seconda opzione include dei vani a giorno sul lato esterno.

The lateral storage unit is available in two depths, 60 or 90 cm (23 5/8" or 35 3/8"). The second option includes open compartments on the outer side.



L'armoire latérale est disponible en deux profondeurs, 60 ou 90 cm. La deuxième option comprend des compartiments ouverts sur le côté extérieur.

El armario lateral está disponible en dos profundidades, 60 ó 90 cm. La segunda opción incluye compartimentos abiertos en el lado exterior.



Scrivanita | Desk | Bureau | Mesa **Fin.** AK, MI, EO
L 200 **P** 90 cm | **W** 78 3/4" **D** 35 3/8"
Dattilo | Return | Retour | Ala **Fin.** AK, EO
L 120 **P** 60 cm | **W** 47 1/4" **D** 23 5/8"



I dattilo possono arrivare fino ad una dimensione di 120 cm di lunghezza per 60 cm di profondità.

Returns can be up to 120 cm (47 1/4") wide by 60 cm (23 5/8") deep.

Les retours peuvent avoir une dimension maxi de 120 cm en longueur et 60 cm en profondeur.

Los dactilos pueden medir hasta 120 cm de largo por 60 cm de profundidad.

Tavolo | Table | Mesa | Fin. GN, CR
L 280 P 120 cm | W 110 1/4" D 47 1/4"



Dettagli

Il profilo in alluminio è disponibile in finitura brill oppure verniciato a polveri epossidiche ed accompagna sempre i piani in vetro, gres e cuoio, mentre è opzionale nella variante melaminico e legno impiallacciato.

Details The aluminium profile is available in brill or epoxy powder-coated finish. This element always comes with glass, porcelain tile and leather tops, while it is optional in the melamine and wood veneer variants.

Détails Le profilé en aluminium est disponible en finition brillante ou avec un revêtement en poudre époxy. Cet élément accompagne toujours les plateaux en verre, en grès et en cuir, tandis qu'il est en option dans les variantes en mélamine et en bois.

Detalles El perfil de aluminio está disponible en acabado brillante o con recubrimiento de polvo epoxi. Este elemento acompaña siempre a las encimeras de cristal, gres y cuero, mientras que es opcional en las variantes de melamina y madera.





Tavolo | Table | Table | Mesa **Fin. NO, EE**
L 280 P 120 cm | W 110 1/4" D 47 1/4"





Tavolo | Table | Mesa
 Fin. NT, EZ
 L 280 P 120 cm | W 110 1/4" D 47 1/4"

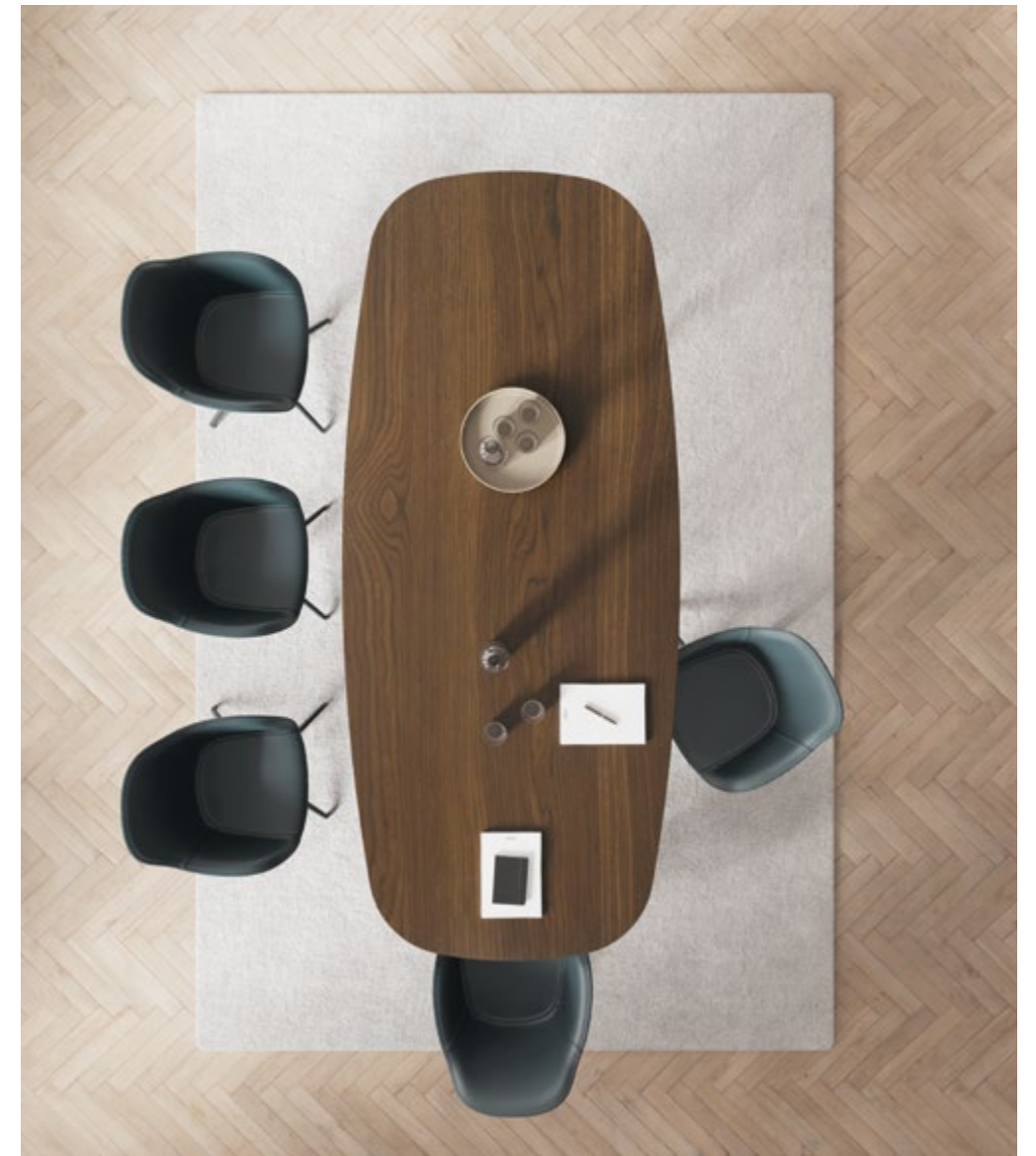

Nuove forme

Per i tavoli è stata introdotta una nuova forma del piano, organica ed armoniosa. Il taglio curvo e l'utilizzo dell'essenza legno rendono la composizione particolarmente raffinata.

New shapes A new, organic and harmonious top shape has been introduced for the tables. The curved cut and the use of wood veneer make it a particularly sophisticated composition.

Nouvelles formes Une nouvelle forme de plateau, organique et harmonieuse, a été introduite pour les tables. La forme incurvée et l'utilisation du bois en font une composition particulièrement raffinée.

Nuevas formas Se ha introducido una nueva forma de tablero, orgánica y armoniosa, para las mesas. El corte curvo y el uso de la madera hacen que la composición sea especialmente refinada.



Riunioni

L'opzione legno è ora disponibile anche nelle dimensioni più grandi. I tavoli riunione in essenza raggiungono quindi i 120 cm di profondità ampliando il range di opzioni per le soluzioni meeting.

Meet The wood option is now available in larger dimensions. Veneer meeting tables reach a depth of 120 cm (47 1/4"), extending the range of options for boardroom solutions.

Réunions L'option bois est maintenant disponible dans de plus grandes dimensions. Les tables de réunion en bois ont donc une profondeur allant jusqu'à 120 cm, ce qui élargit l'éventail des options pour les solutions de réunion.

Reuniones La opción de madera ahora también está disponible tamaños más grandes. Las mesas de reuniones en madera tienen ahora hasta 120 cm de profundidad, lo que amplía la gama de opciones de soluciones para reuniones.

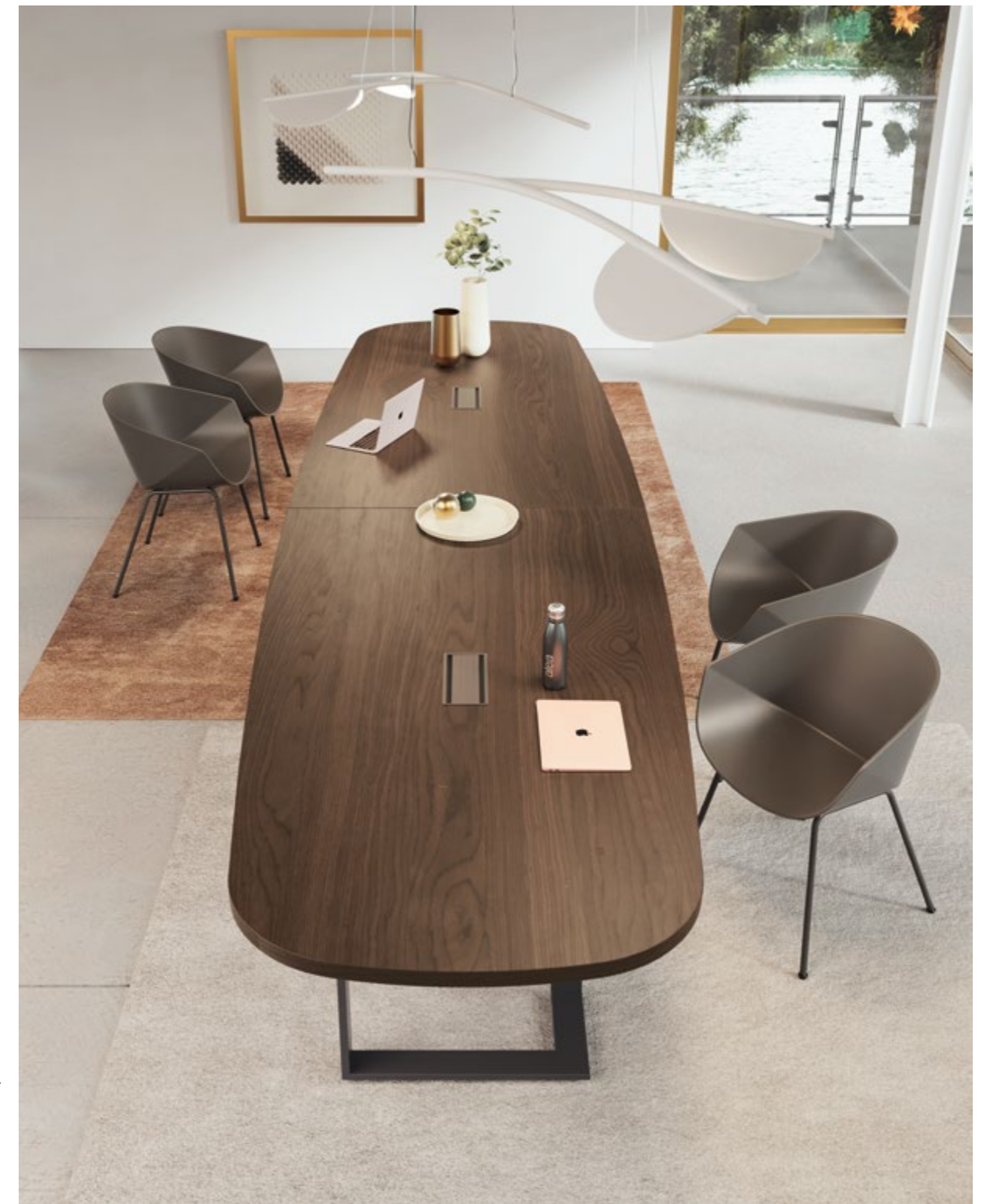

Tavolo | Table | Mesa **Fin. NT, El**
L 440 P 120 cm | W 173 1/4" D 47 1/4"



Tavolo | Table | Mesa **Fin.** CN (leather custom), EN
L 590 P 150 cm | W 232 1/4" D 59"



The tables extend to a length of 590 cm (232 1/4"). The composition is enriched with two central ring legs that add support to the structure.

Les tables ont une longueur de 590 cm. La composition est enrichie de deux pieds anneaux centraux qui ajoutent du soutien à la structure.

Las mesas se extienden hasta una longitud de 590 cm. La composición se enriquece con dos patas anillo centrales que añaden soporte a la estructura.



I tavoli si estendono fino a raggiungere i 590 cm di lunghezza. La composizione viene arricchita di due gambe ad anello centrali che aggiungono sostegno alla struttura.



Collezione

Archimede comprende una selezione di complementi d'arredo che vanno a completare l'offerta. I tavolini da caffè ad esempio sono utili a definire aree più informali mantenendo i tratti distintivi della collezione.

Collection Archimede includes a selection of furnishing accessories to complete the offer. Coffee tables, for example, are useful for defining more informal areas while maintaining the distinctive features of the collection.

Collection Archimede propose une sélection d'accessoires d'ameublement pour compléter l'offre. Les tables basses, par exemple, sont utiles pour définir des zones plus informelles tout en conservant les caractéristiques distinctives de la collection.

Colección Archimede incluye una selección de accesorios de decoración para completar la oferta. Las mesas de centro, por ejemplo, resultan útiles para delimitar zonas más informales manteniendo los rasgos distintivos de la colección.





Libreria | Bookcase | Bibliothèque | Libroero **Fin.** MM, MJ, EI
L 272 **P** 36 **H** 191 cm | **W** 107 1/8" **D** 14 1/8" **H** 75 1/4"

La libreria Archimede è definita da una struttura con disegno ad L, confermando la geometria distintiva della collezione. Viene proposta nella variante con 5 ripiani oppure ripiani e vano TV.

The Archimede bookcase is defined by an L-shaped structure, confirming the distinctive geometry of the collection. It is available in the variant with 5 shelves or shelves and TV compartment.

La bibliothèque Archimede est définie par une structure en forme de L, confirmant la géométrie distinctive de la collection. Elle est disponible dans la variante avec 5 étagères ou étagères et compartiment TV.

La librería Archimede se define por una estructura en forma de L, que confirma la geometría distintiva de la colección. Está disponible en la variante con 5 estantes o estantes y compartimento para TV.



Piani | Desk tops | Plateaux | Sobres

Spessore 4 cm | 4 cm (1 5/8") thick | 4 cm d'épaisseur | 4 cm de espesor

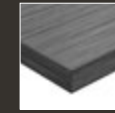

Senza profilo - legno/melaminico
Without profile - wood veneer/Italian melamine
Sans profil - bois/melaminé
Sin perfil - madera/melaminico

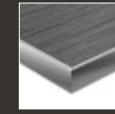

Con profilo - legno/melaminico/cuoio/vetro/gres
With profile - wood veneer/Italian melamine/leather/glass/porcelain tiles
Avec profil - bois/melaminé/cuir/verre/grès cérame
Con perfil - madera/melaminico/cuero/vidrio/gres porcelánico

Gambe | Legs | Pieds | Patas

Sezione 8x2 cm | Section 8x2 cm (3 1/8"x3/4") thick | Section 8x2 cm | Sección 8x2 cm

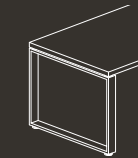

Gamba ad anello
Ring leg
Pied en anneau
Pata en anillo

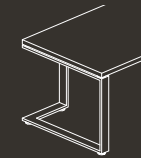

gamba a L
L leg
pied en L
pata en L



Gamba a T
T leg
Pied en T
Pata en T

Scrivanie | Desks | Bureaux | Mesas

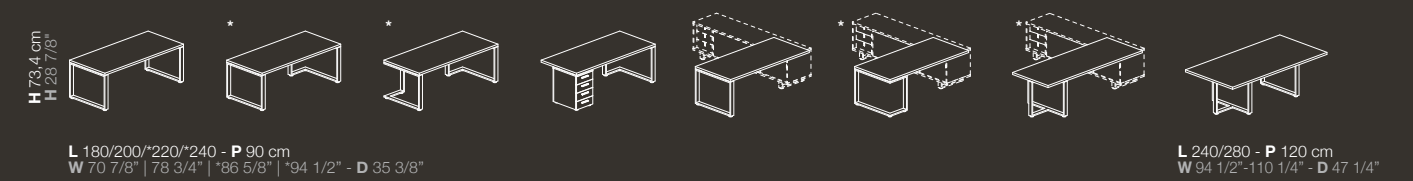

Dattilo | Returns | Retours | Alas

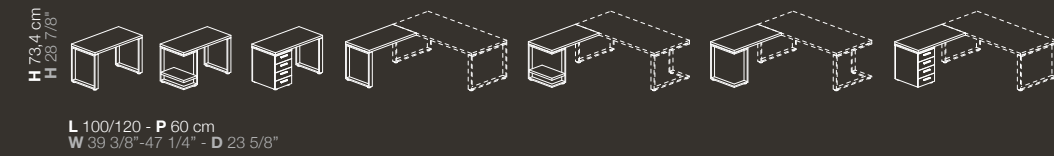

Tavoli riunione | Meeting tables | Tables de réunion | Mesas de juntas

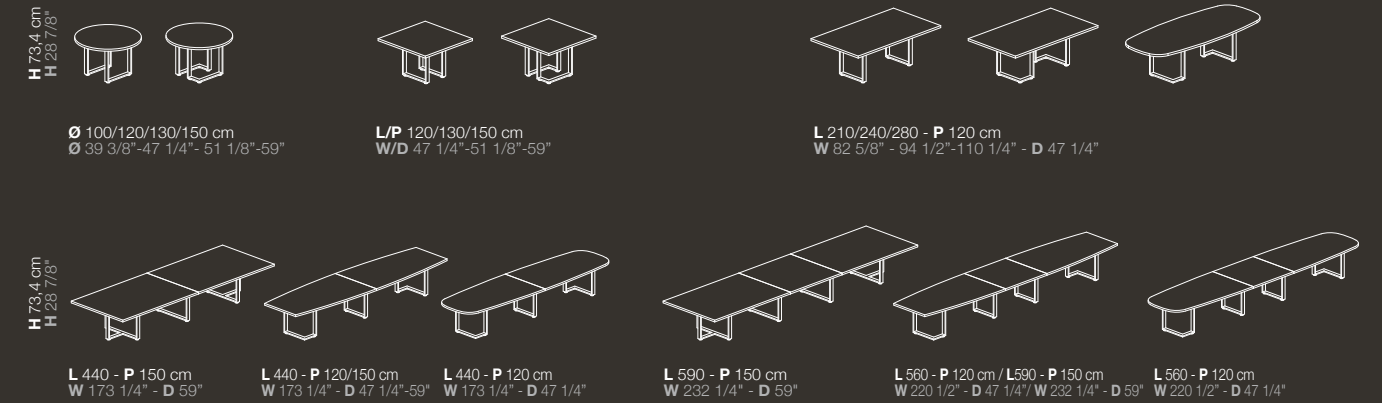

Mobili di servizio | Service units | Meuble retour | Muebles de servicio

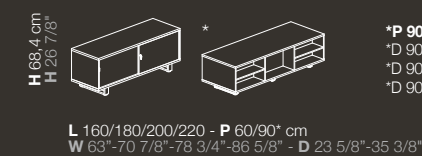

***P 90 cm con vani a giorno esterni**
*D 90 cm (35 3/8") with external open compartments
*D 90 cm avec compartiments extérieurs ouverts
*D 90 cm con compartimentos abiertos externos

Tavolini da caffè | Coffee tables | Tables basses | Mesitas



Librerie | Bookshelves | Bibliothèque | Librerros

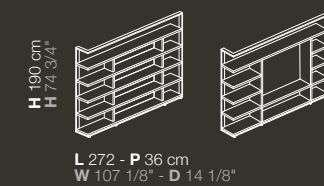













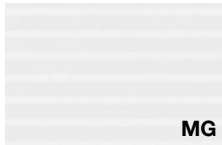



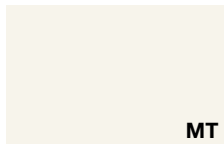

Finiture | Finishes | Finitions | Acabados

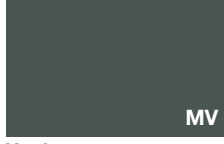
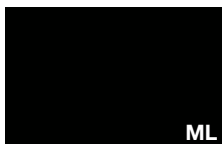
MEL

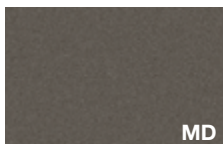
Melaminico

Melamine | Mélaminé | Melaminico

TOP MOB MOD





 Bianco rigato Rippled effect white Blanc avec rayures en sérigraphie Blanco rayado	 Grigio rigato Rippled effect grey Gris avec rayures en sérigraphie Gris rayado	 Nichel Nickel Nickel Niquel	 Cacao Cocoa Cacao Cacao	 Bianco White Blanc Blanco
 Talco Talco Talco Talco	 Ocra Ochre Ocre Ocre	 Terracotta Terracotta Terracotta Terracotta	 Safari Safari Safari Safari	 Noisette Noisette Noisette Noisette
 Verde Green Vert Verde	 Nero Black Noir Negro	 Blu notte Night blue Bleu nuit Azul noche	 Ardesia Ardesia Ardesia Pizarra	 Rovere chiaro Light oak Chêne clair Roble claro
 Rovere americano American oak Chêne américain Roble americano	 Rovere grigio Grey oak Chêne gris Roble gris	 Rovere moro Dark oak Chêne foncé Roble oscuro	 Noce Canaletto Canaletto Walnut Noyer Canaletto Nogal Canaletto	 Noce scuro Dark walnut Noyer foncé Nogal oscuro

LGN

Legno

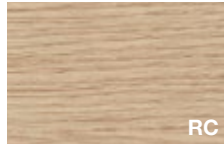
Wood | Bois | Madera

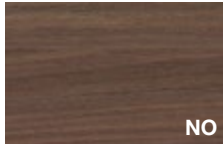
TOP MOB MOD

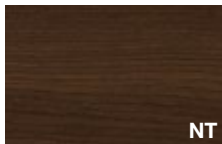









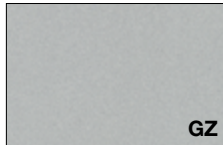

 Rovere chiaro Light oak Chêne clair Roble claro	 Rovere grigio fumo Smoke grey oak Chêne gris de fumée Roble gris humo	 Rovere moro Dark oak Chêne foncé Roble oscuro	 Noce Canaletto Canaletto walnut Noyer Canaletto Nogal Canaletto	 Ebano silver Silver ebony Ebony silver Ebano plata
 Ebano Makassar Makassar ebony Ebony Makassar Ebano Makassar	 Noce termocotto Heat-treated walnut Noyer thermo traité Nogal termotratado			

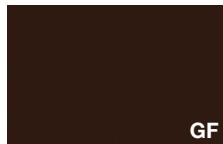
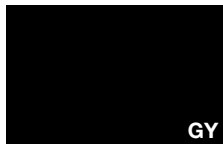
VTR

Vetro (anche antimpronta NFG)

Glass (also antifinger NFG) | Verre (également antitaches) | Vidrio (también anti-huella)

TOP



 Bianco White Blanc Blanco	 Argento Silver Argent Plata	 Grigio scuro Dark grey Gris foncé Gris oscuro	 Noisette Noisette Noisette Noisette	 Ardesia Ardesia Ardesia Pizarra
 Moka Mocha Moka Café	 Nero Black Noir Negro	 Arancione Orange Orange Naranja	 Rosso "F" Red "F" Rouge "F" Rojo "F"	 Rubino Ruby Rubis Rubi
 Indaco Indigo Indigo Azul Indigo	 Azzurro Blue Bleu Azul	 Verde Green Vert Verde	 Cedro Lime green Vert Cédtrat Verde Cedro	

GRES

Gres porcellanato

Porcelain tiles | Grès cérame | Gres porcelánico

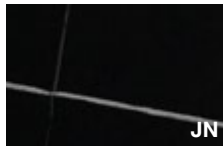
TOP

 Nero Black Noir Negro	 Basalt Basalt Basalt Basalt	 Calacatta Calacatta Calacatta Calacatta	 Pulpis Pulpis Pulpis Pulpis	 Corten Corten Corten Corten
--	--	--	--	--

CUO

Cuoio

Leather | Cuir | Cuero

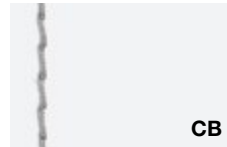

Bianco
White
Blanc
Blanco



Alluminio
Aluminium
Aluminium
Aluminio



Nero
Black
Noir
Negro



Testa di moro
Brown
Tete de maure
Marron oscuro



Caramello
Caramel
Caramel
Caramelo



Arancione
Orange
Orange
Naranja

MTC

Metacrilato

Acrylic | Méthacrylate | Metacrilato



Bianco opalino
Opaline white
Blanc opalin
Blanco opaco

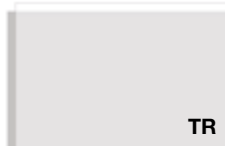

Trasparente
Transparent
Transparent
Transparente



Rosso trasparente
Red transparent
Rouge transparent
Rojo transparente



Blu trasparente
Blue transparent
Bleu transparent
Azul transparente



Bianco satinato
Satin-finish white
Blanc satiné
Blanco satinado



Grigio fumè satinato
Satin-finish smoky grey
Gris satiné
Gris satinado



Arancione satinato
Satin-finish orange
Orange satiné
Naranja satinado



Blu satinato
Satin-finish blue
Bleu satiné
Azul satinado



Verde satinato
Satin-finish green
Vert satiné
Verde satinado

TOP

MOB

GOF

Metacrilato retrolaccato

Backpainted acrylic | Méthacrylate rétro-laqué | Metacrilato retrolacado



Bianco
White
Blanc
Blanco

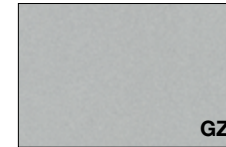

Argento
Silver
Argent
Plata



Grigio scuro
Dark grey
Gris foncé
Gris oscuro



Noisette
Noisette
Noisette
Noisette

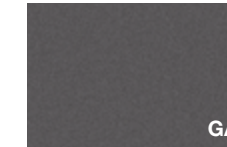

Ardesia
Ardesia
Ardesia
Pizarra

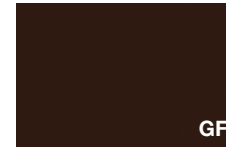

Moka
Mocha
Moka
Cafe

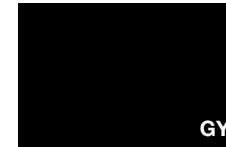

Nero
Black
Noir
Negro



Arancione
Orange
Orange
Naranja



Rosso "F"
Red "F"
Rouge "F"
Rojo "F"



Rubino
Ruby
Rubis
Rubi



Indaco
Indigo
Indigo
Azul Indigo



Azzurro
Blue
Bleu
Azul



Verde
Green
Vert
Verde



Cedro
Lime green
Vert Cédrat
Verde Cedro

MOB

PR

CRM

Acciaio inox

Stainless steel | Acier inoxydable | Acero inoxidable



Lucido
Polished
Poli
Pulido

STRU



Brill
Brill
Brill
Brill

AL

Alluminio

Aluminium | Aluminium | Aluminio



Alluminio
Aluminium
Aluminium
Aluminio

PR

EPX

Epossidico

Epoxy | Époxy | Epoxi



Applicazioni finiture

Finish application | Application finitions | Aplicacion acabados



Ambiente e sicurezza | Environment and safety | Environnement et sécurité | Medio ambiente y seguridad

Ecologia: Alea utilizza per i suoi prodotti e i suoi imballi materiali facilmente separabili e riciclabili. (Immagine 1)

Catena Di Custodia COC: Alea si impegna ad utilizzare materiali legnosi certificati FSC® e pannelli a base di legno con certificazione CARB2.

I pannelli CARB2 presentano un rilascio di formaldeide inferiore rispetto al pannello E1 comunemente utilizzato (classe E1 secondo il DM 10/10/2008).

I prodotti certificati FSC® (License Code FSC-C118323) sono disponibili su richiesta: contattate i nostri uffici per maggiori informazioni. (Immagine 2)

LEED: Gli arredi di Alea possono contribuire al conseguimento del punteggio di certificazione LEED per i crediti indicati nei product badge. (Immagine 3)

Sistemi di Gestione certificati ISO 9001, ISO 14001, ISO 45001: Alea è attivamente impegnata nel raggiungere standard elevati di qualità e responsabilità attraverso l'adozione di sistemi di gestione certificati ISO per garantire prodotti e servizi di elevata qualità, in grado di soddisfare le aspettative dei clienti, di assicurare un ambiente di lavoro sicuro e di monitorare regolarmente l'impatto ambientale delle nostre attività. (Immagine 4)

Attestazione di prodotto: I prodotti Alea sono stati sottoposti a prove prestazionali presso laboratori di prova accreditati.

Copia dei rapporti di prova o delle attestazioni di conformità sono disponibili su richiesta. (Immagine 5)

Eco-friendly: Alea uses easily separable and recyclable materials for its products and packaging. (Image 1)

Chain of Custody (COC): Alea is committed to using FSC® certified wood materials and CARB2-certified wood-based panels. CARB2 panels have lower formaldehyde emissions compared to the commonly used E1 panels (class E1 according to the DM 10/10/2008). FSC® certified products (License Code FSC-C118323) are available upon request: please contact our offices for more information. (Image 2)

LEED: The A65 system can contribute to obtaining LEED certification points for the credits indicated in the product badges. (Image 3)

ISO 9001, ISO 14001, ISO 45001 Certified Management Systems: Alea is actively committed to achieving high standards of quality and responsibility through the adoption of ISO certified management systems to ensure high-quality products and services that meet customer expectations, provide a safe working environment, and regularly monitor the environmental impact of our activities. (Image 4)

Product Certification: Alea products have undergone performance tests by accredited testing laboratories. Copies of test reports or certificates of conformity are available upon request. (Image 5)



Ambiente e sicurezza | Environment and safety | Environnement et sécurité | Medio ambiente y seguridad

Écologie: Alea utilise pour ses produits et ses emballages des matériaux facilement séparables et recyclables. (Image 1)

Chaîne de contrôle COC: Alea a à cœur d'utiliser des matériaux en bois certifiés FSC® et des panneaux à base de bois avec la certification CARB2.

Les panneaux CARB2 présentent une émission de formaldéhyde inférieure à celle des panneaux E1 couramment utilisés (classe E1 selon le DM 10/10/2008). Les produits certifiés FSC® (Code de licence FSC-C118323) sont disponibles sur demande : veuillez contacter nos bureaux pour plus d'informations. (Image 2)

LEED: Le système A65 peut contribuer à l'obtention des points de certification LEED pour les crédits indiqués dans les badges produits. (Image 3)

Systèmes de gestion certifiés ISO 9001, ISO 14001, ISO 45001: Alea s'engage activement à atteindre des normes élevées de qualité et de responsabilité à travers l'adoption de systèmes de gestion certifiés ISO pour garantir des produits et services de haute qualité, répondre aux attentes des clients, assurer un environnement de travail sûr et surveiller régulièrement l'impact environnemental de nos activités. (Image 4)

Attestation de produit: Les produits Alea ont été soumis à des tests de performance dans des laboratoires d'essais accrédités. Des copies des rapports de tests ou des certificats de conformité sont disponibles sur demande. (Image 5)

Ecología: Alea utiliza para sus productos y embalajes materiales fácilmente separables y reciclables. (Imagen 1)

Cadena de Custodia COC: Alea se compromete a utilizar materiales de madera certificados por FSC® y paneles a base de madera con certificación CARB2.

Los paneles CARB2 presentan una emisión de formaldehído inferior en comparación con los paneles E1 comúnmente utilizados (clase E1 según el DM 10/10/2008). Los productos certificados por FSC® (Código de Licencia FSC-C118323) están disponibles bajo solicitud: por favor contacte a nuestras oficinas para más información. (Imagen 2)

LEED: El sistema A65 puede contribuir a la consecución de la puntuación de certificación LEED para los créditos indicados en los product badges. (Imagen 3)

Sistemas de Gestión Certificados ISO 9001, ISO 14001, ISO 45001: Alea está comprometida activamente en alcanzar altos estándares de calidad y responsabilidad mediante la adopción de sistemas de gestión certificados por ISO para garantizar productos y servicios de alta calidad, que cumplen con las expectativas de los clientes, aseguran un entorno de trabajo seguro y monitorean regularmente el impacto ambiental de nuestras actividades. (Imagen 4)

Certificación de Producto: Los productos Alea han sido sometidos a pruebas de rendimiento en laboratorios acreditados. Las copias de los informes de prueba o los certificados de conformidad están disponibles bajo solicitud. (Imagen 5)

1. 



Concept, visual & graphic design

Alea marketing + communication

Design

Mirto Antonel

Art direction

Mirto Antonel

Si ringrazia M.artedesign

martedesign.it

AD/CACD/AD

Le immagini dei prodotti visibili all'interno di questo catalogo sono inserite a scopo puramente indicativo
The images of the products visible in this catalogue are included for information purposes only
Les images des produits visibles dans ce catalogue sont incluses à titre informatif uniquement
Las imágenes de los productos visibles en este catálogo se incluyen sólo con fines informativos

alea
aleaoffice.com



GLOBAL HEADQUARTERS AND SHOWROOM : Via Col de Rust, 19 - 33070 Sarone (PN) - Italia : Tel ++39 0434 777 333
email: info@aleaoffice.com **PARIS SHOWROOM** : 176 Avenue Charles de Gaulle 92200, Neuilly-sur-Seine - France **NORTH AMERICAN**
HEADQUARTERS : Midtown 2, 3449 NE 1st Avenue L-32, Miami, FL 33137 - USA ; Tel ++1 305 470 1200 - email: info@alea-usa.com
ALEA UK OFFICE AND SHOWROOM : 50-54 Clerkenwell Road, London EC1M 5PS - email: info@aleaoffice.com