

alea

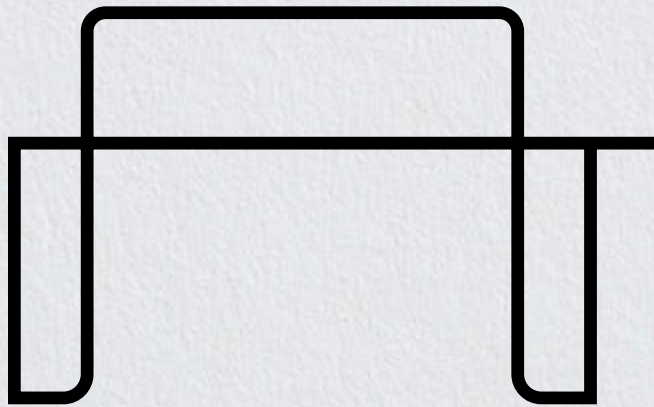

Itube

workstations

 **ADI
DESIGN
INDEX**
Selezione Compasso d'Oro

Segno

Itube è una collezione operativa dove l'estetica diventa funzione.

La sua struttura è definita da un segno continuo che interseca e sostiene il piano.

Itube is a collection where aesthetics becomes function. Its structure is a continuous sign that intersects and supports the top.

Itube est une collection où l'esthétique devient fonction. Sa structure est un signe continu qui s'entrecroise et soutient le sommet.

Itube es una colección en la que la estética se convierte en función. Su estructura es un signo continuo que se cruza y sostiene la parte superior.

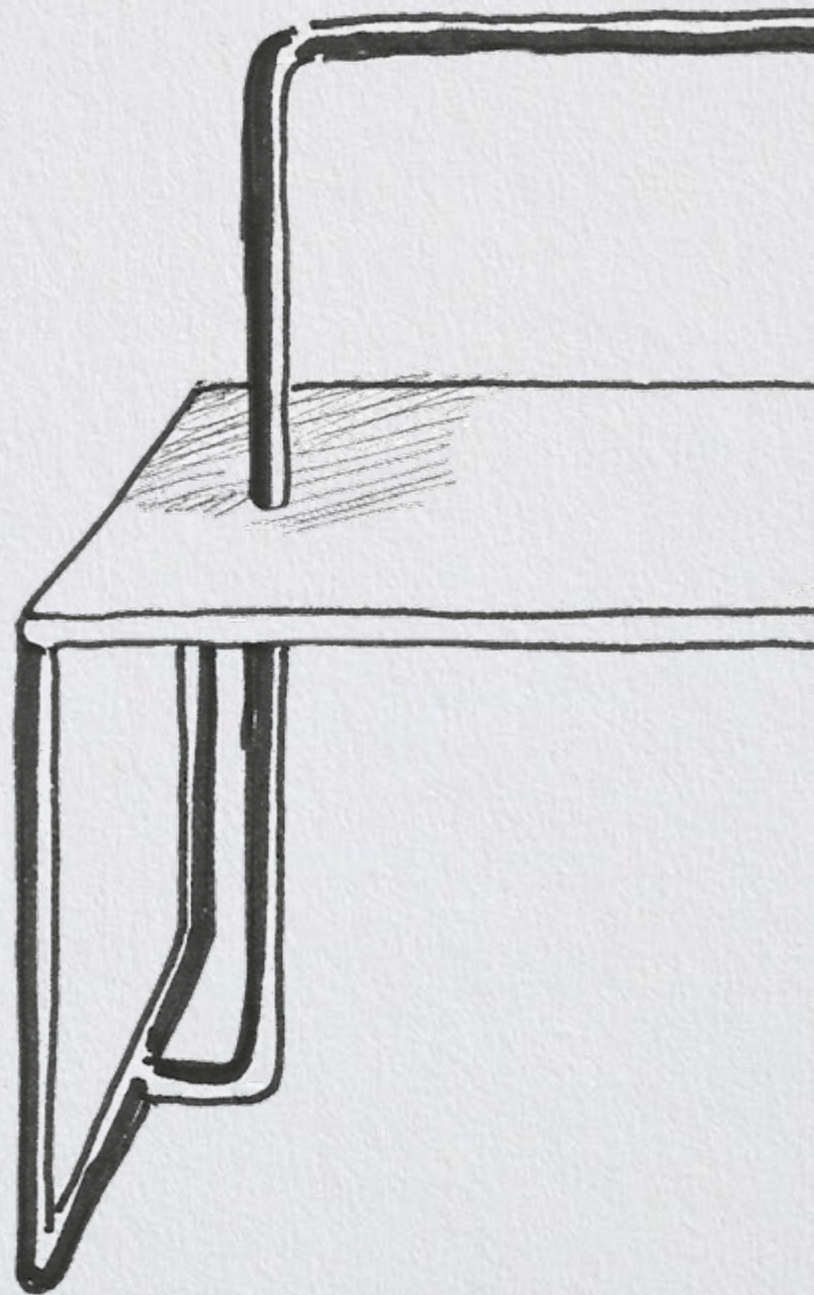



Caratteristiche

Il profilo tubolare in Itube è di diametro 35 mm e le sue gambe curvilinee rendono armoniosa la struttura.

Bench | Bench | Bench | Bench **Fin.** MN, EB, XE
L 400 P 160 H 73,4 cm | W 157 1/2" D 63" H 29"



Features The tubular profile in Itube has a diameter of 35 mm (1 3/8") and the curved legs create a harmonious design.

Caractéristiques La forme tubulaire qui constitue Itube a un diamètre de 35 mm et ses pieds ont des rayons à chaque changement de direction de la structure.

Características El perfil tubular de Itube es de 35 mm de diámetro y sus patas curvilíneas hacen armoniosa la estructura.





Funzionalità

Itube è stato pensato con diverse tipologie di accessori: mensole rettangolari o dalla forma organica, portapiante e vani portaoggetti incassati tra i semipiani.

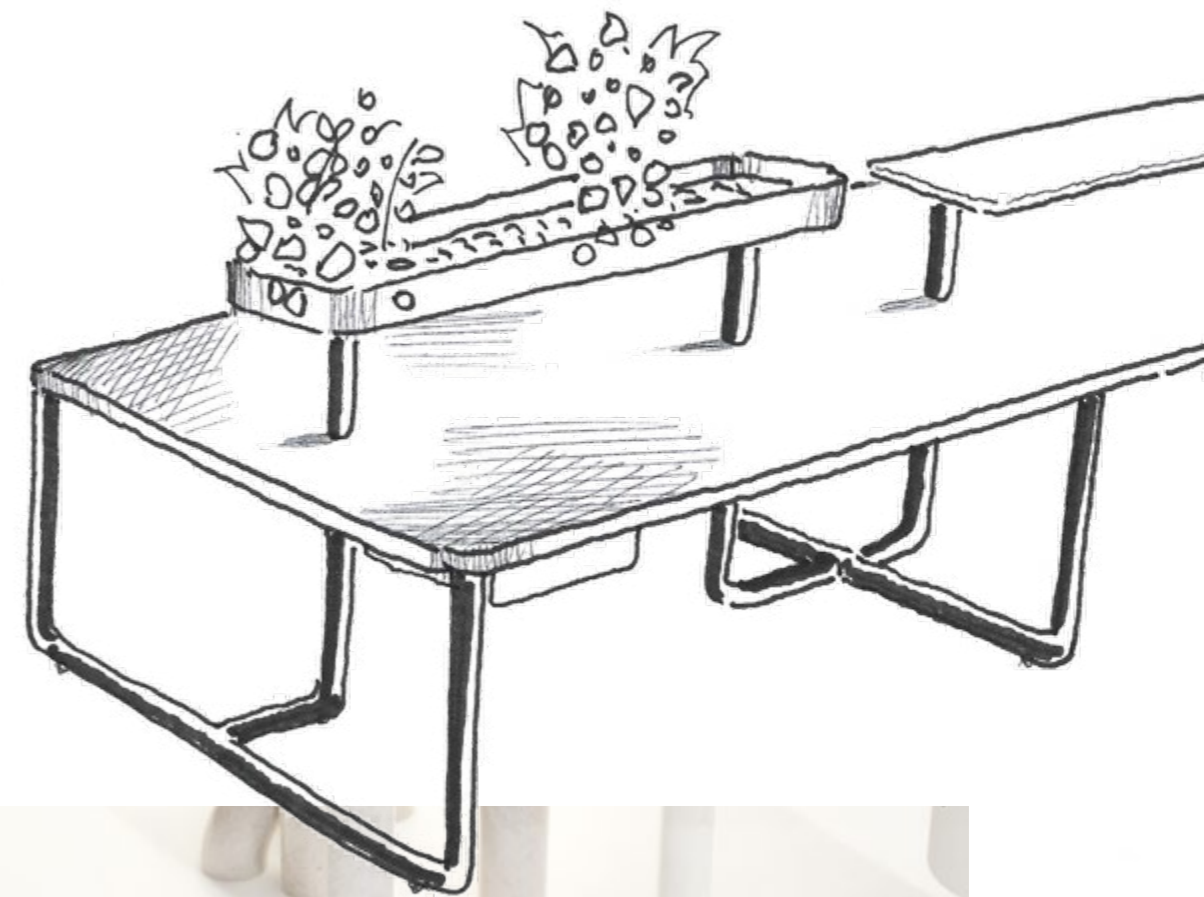

Bench | Bench | Bench | Bench **Fin.** XB, YB
L 360 P 120 H 73,4 cm | W 141 3/4" D 47 1/4" H 29"



Functionality Itube has been designed with three types of accessories: rectangular or leaf shaped shelves, plant holders and built-in compartments.

Fonctionnalité Itube a été conçu avec trois types d'accessoires : des étagères rectangulaires ou de forme organique, des porte-plantes et des bacs encastrés entre demi-plateaux.

Funcionalidad Itube se ha diseñado con tres tipos de accesorios: estantes rectangulares o de forma orgánica, jardineras y bandejas portaobjetos empotradas entre los sobres.



Bench | Bench | Bench | Bench **Fin.** MK, XB, YB, DC
L 180 P 160 H 73,4 cm | W 70 7/8" D 63" H 29"

Altezze

Il tubo che attraversa il bench
soprapiano è disponibile in due
altezze: 69,4 cm e 40 cm.







Heights The tube that crosses the bench above the table top is provided in two different heights: 69,4 cm high (27 3/8") and 40 cm high (15 3/4").

Hauteurs Le tube qui traverse le bench au-dessus du plateau est fourni en deux hauteurs différentes : 69,4 cm et 40 cm.

Alturas El tubo que atraviesa la encimera, sobre mesa, está disponible en dos alturas: 69,4 cm y 40 cm.

Bench | Bench | Bench | Bench **Fin.** ML, EN, DI
L 280 **P** 160 **H** 73,4 cm | **W** 110 1/4" **D** 63" **H** 29"





Carattere

Itube diventa funky nelle sue declinazioni più decise. Perfetto per ambienti coworking dal taglio fresco e dinamico.



Personality Itube gets funky in its most unexpected proposal. Perfect for fresh and dynamic coworking environments.

Caractère Itube devient funky dans ses déclinaisons les plus fortes. Parfait pour les environnements de coworking frais et dynamiques.

Personalidad Itube se pone jocoso en sus declinaciones más extravagantes. Perfecto para entornos de coworking frescos y dinámicos.





Bench | Bench | Bench | Bench **Fin.** MK, EK, FF
L 400 P 160 H 73,4 cm | W 157 1/2" D 63" H 29"

Esclusivo

Itube introduce per la prima volta la tenda come elemento dinamico. Può anche essere utilizzata per separare postazioni di lavoro, cosicché il lavoratore possa definire il proprio spazio.

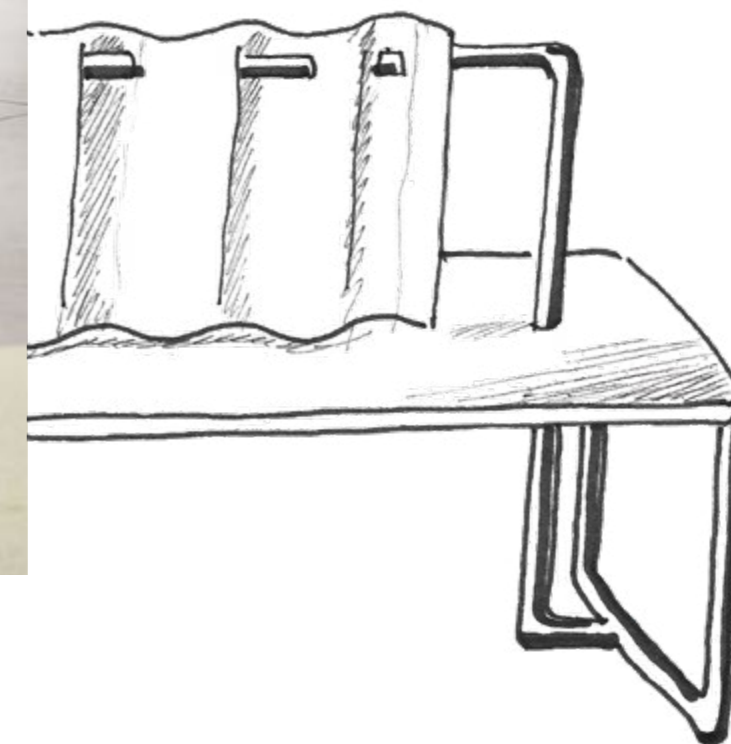



Exclusivo Itube introduces the curtain for the first time as a dynamic element. Used to separate workstations, it enables users to define their own space.

Exclusif Itube présente pour la première fois le rideau comme un élément dynamique. Il peut séparer les postes de travail ou non, créant ainsi une interaction avec le travailleur dans la définition de son espace.

Exclusivo Itube introduce por primera vez la cortina como elemento dinámico. También puede utilizarse para separar puestos de trabajo, de modo que el trabajador pueda definir su propio espacio.



Lineare

Una delle declinazioni della collezione è il bench lineare. Si prevede che gli utenti si posizionino da un lato soltanto e questo rende il bench particolarmente adatto ad essere collocato fronte finestra o parete. Si addice ad ambienti universitari e biblioteche.

Linear One of the proposals of this collection is the linear bench. Users can sit on the same side, making it suitable near windows or walls, and especially in university environments and libraries.

Linéaire L'une des déclinaisons de la collection est le bench linéaire. Sa particularité réside dans le fait qu'il accueille l'utilisateur d'un seul côté, ce qui le rend particulièrement adapté pour se positionner en face d'une fenêtre ou à un mur, et il convient également aux environnements universitaires et aux bibliothèques.

Lineal Una de las declinaciones de la colección es el bench lineal. Está previsto que los usuarios se sienten en un sólo lado y esto hace que el bench sea especialmente adecuado para colocarlo frente a una ventana o una pared. Es apto para entornos universitarios y bibliotecas.

Bench | Bench | Bench | Bench **Fin.** XC, YC
L 360 P 90 H 73,4 cm | W 141 3/4" D 35 3/8" H 29"





Tavolo | Table | Mesa **Fin.** MZ, EZ
L 280 P 120 H 73,4 cm | W 110 1/4" D 47 1/4" H 29"



Tavolo | Table | Mesa **Fin.** Min. EB
L 280 P 120 H 73,4 cm | W 110 1/4" D 47 1/4" H 29"

Tavoli

Le curve che caratterizzano la struttura si riflettono anche nei piani e si ritrovano nelle forme ovoidale, rettangolare e tonda.



Tables The curves that characterise the structure also define the rectangular, oval and round table tops.

Tables Itube a été conçu avec trois types d'accessoires: des étagères rectangulaires ou de forme organique, des porte-plantes et des bacs encastrés entre demi-plateaux.

Tablas Las curvas que caracterizan la estructura se reflejan en los sobros también y se encuentran en las formas ovalizada, rectangular y redonda.



Tavolo | Table | Mesa **Fin.** MIN, EB / XB, YB
Ø 120 H 73,4 cm | Ø 47 1/4" H 29"

Scrivanie

La scrivania completa l'offerta della collezione Itube. Le sue linee leggere e funky contribuiscono ad alleggerire l'atmosfera circostante.

Executive The desk completes the Itube collection offer. With its light, unique lines, it lightens the tone of the workspace environment.



Scrivanie | Desk | Bureau | Mesa **Fin.** XV, YV
L 200 P 90 H 73,4 cm | W 78 3/4" D 35 3/8" H 29"

Dattilo | Return | Retour | Ala **Fin.** XV, YV
L 120 P 60 H 73,4 cm | W 47 1/4" D 23 5/8" H 29"

Bureaux Le bureau complète l'offre de la collection Itube. Avec ses lignes légères et funky, il allège le ton de l'espace de travail.

Escritorio El escritorio completa la oferta de la colección Itube. Sus líneas ligeras y extravagantes contribuyen a aligerar el ambiente.

Composizioni

Itube prevede l'aggiunta anche di screen puntaspilli (spessore 30 mm) frontali, direttamente fissati al piano, e laterali, in appoggio e per questo facilmente removibili.



Compositions Itube also includes frontal pinnable screens (30 mm, 1 3/16", thick), fixed onto the desktop, and lateral movable screens supported by round metal bases.

Compositions Itube prévoit l'ajoute d'écrans frontaux punaisables (ép. 30 mm), directement fixés au plateau, et latéraux en appui donc facilement amovibles.

Composiciones Itube también prevé la adición de paneles separadores pinchables (30 mm de espesor) frontales, que se fijan directamente al sobre, y laterales que se apoyan y desmontan fácilmente.

Bench 2P | Bench 2P | Bench 2P | Bench 2P **Fin.** MK, EK, DC
L 200 P 160 H 73,4 cm | W 78 3/4" D 63" H 29"

Bench 4P | Bench 4P | Bench 4P | Bench 4P **Fin.** MK, EK, DC
L 400 P 160 H 73,4 cm | W 157 1/2" D 63" H 29"

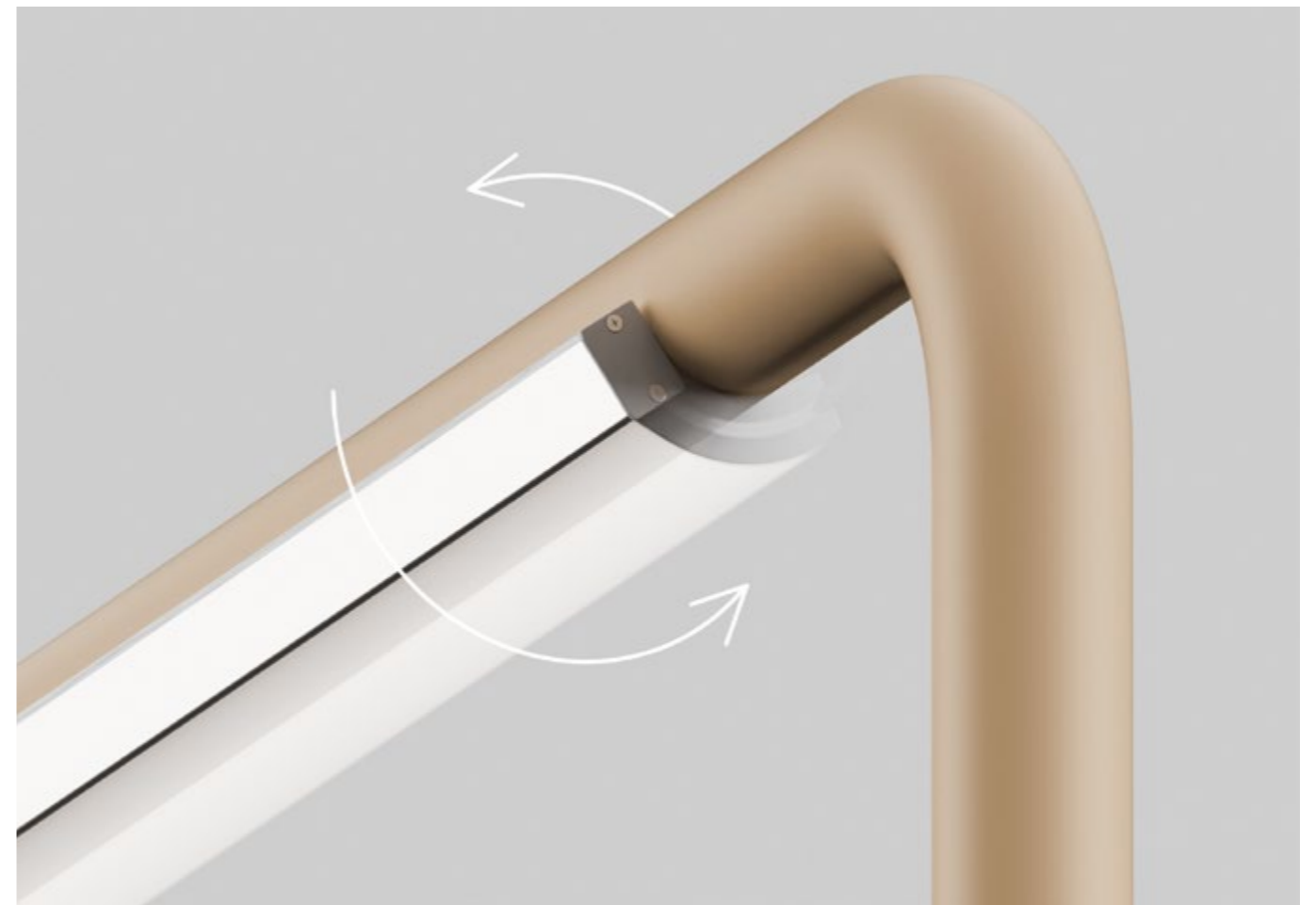
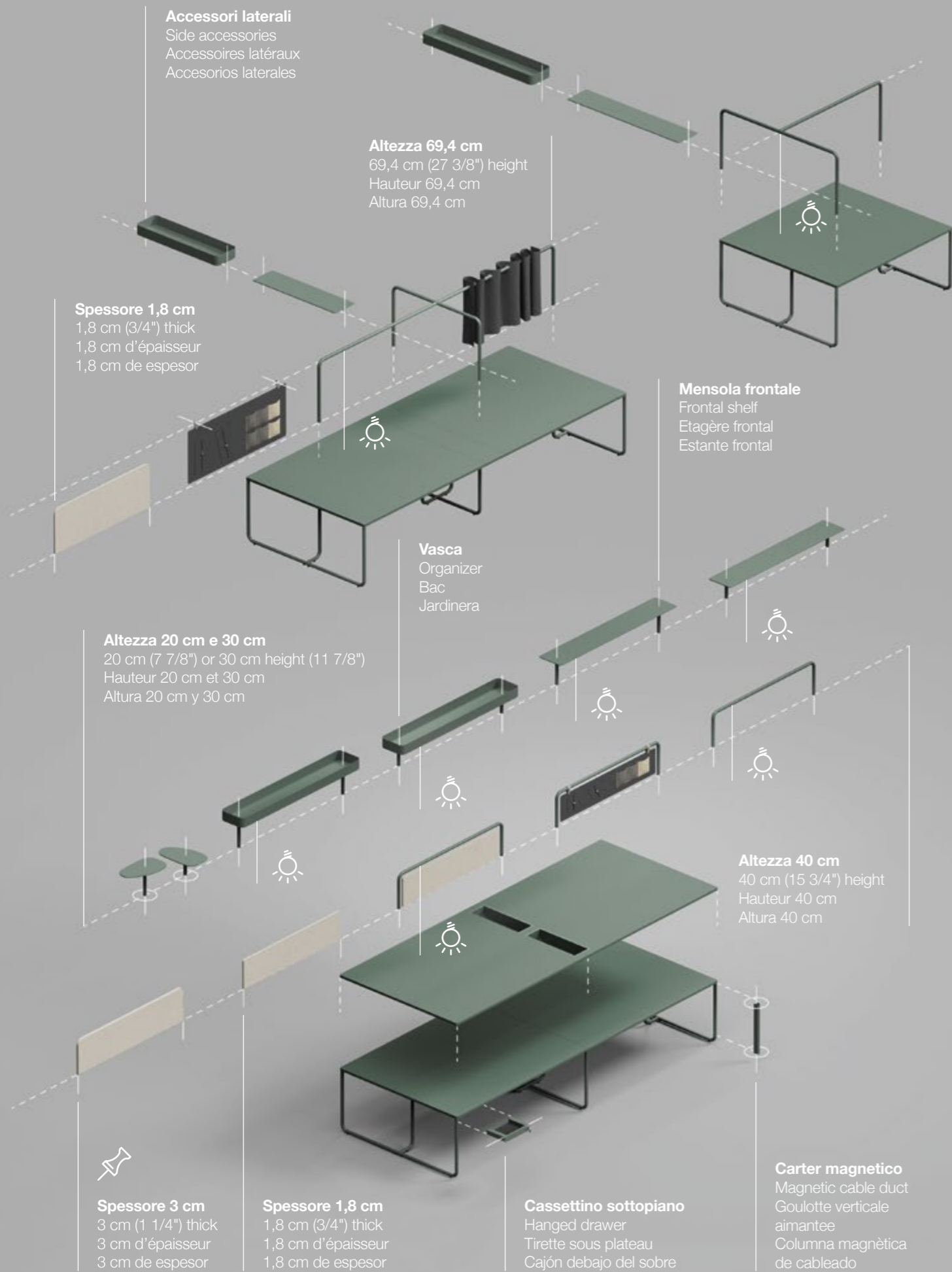

Piani | Desk tops | Plateaux | Sobres

Spessore 3 cm | 3 cm (1 1/4") thick | 3 cm d'épaisseur | 3 cm de espesor

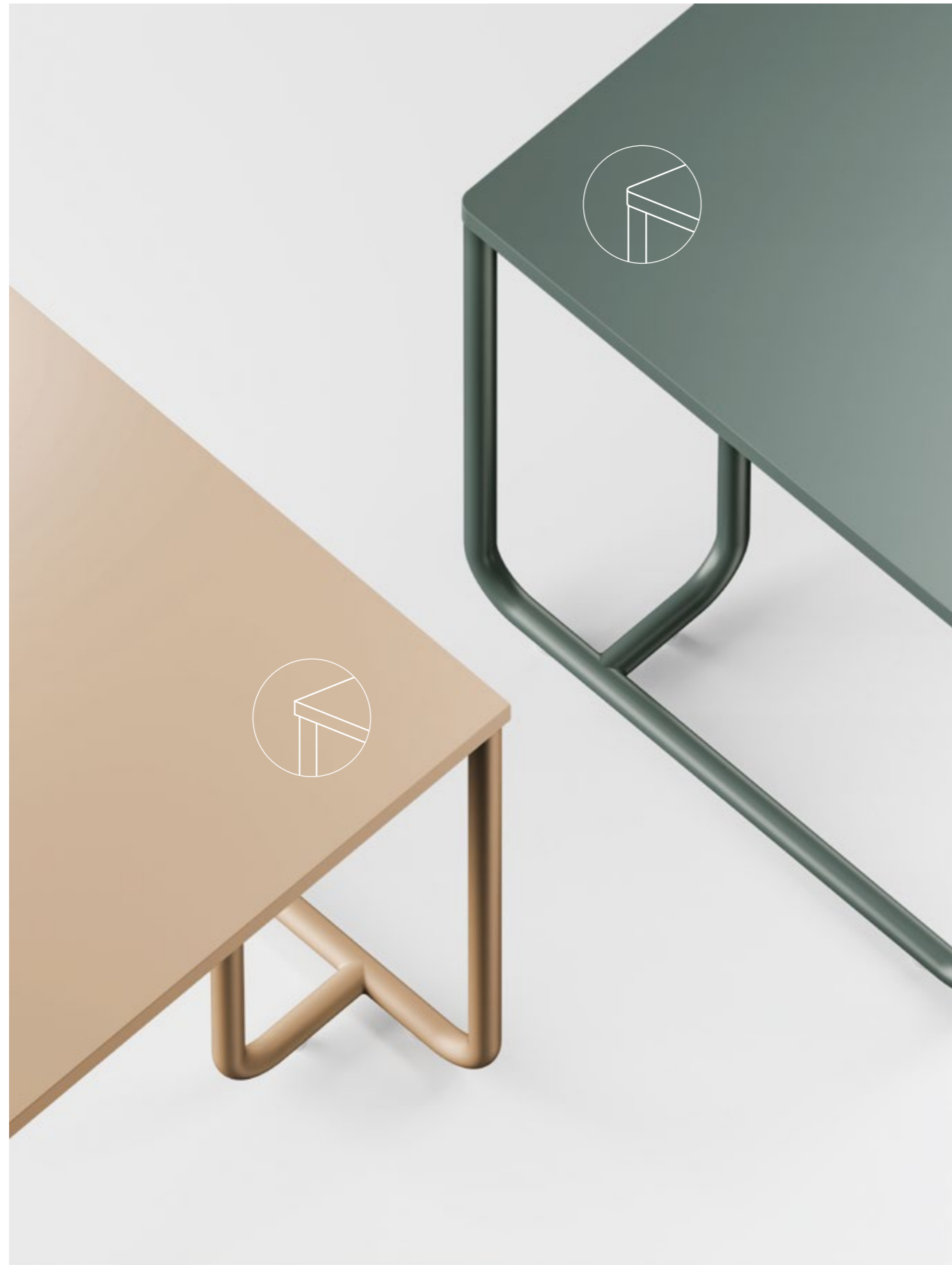

Piani | Desk tops | Plateaux | Sobres

Spessore 3 cm | 3 cm (1 1/4") thick | 3 cm d'épaisseur | 3 cm de espesor

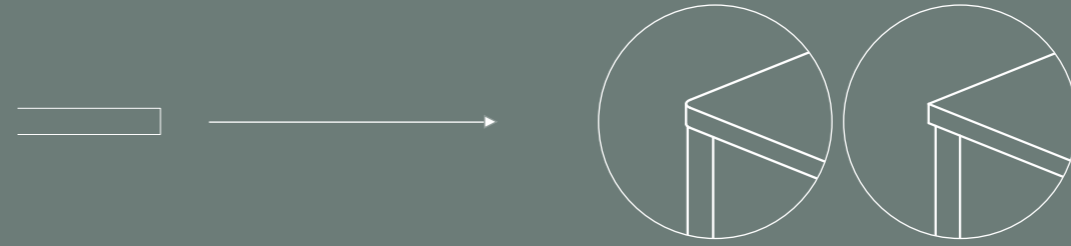

Scrivanie/tavoli | Desks/tables | Bureaux/tables | Escritorios/Mesas

Dattilo | Return | Retours | Alas

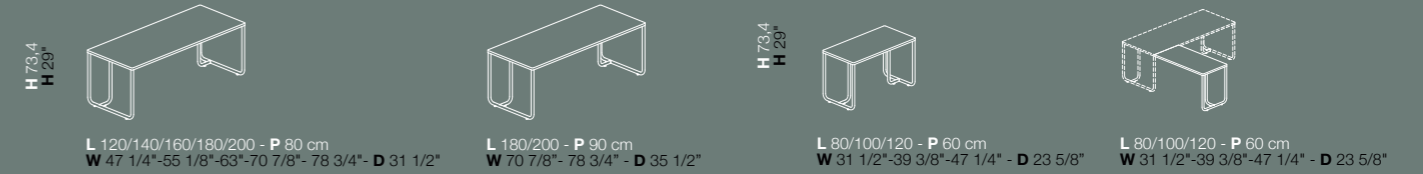

Bench lineare | Line bench | Bench linéaire | Mesas colectivas

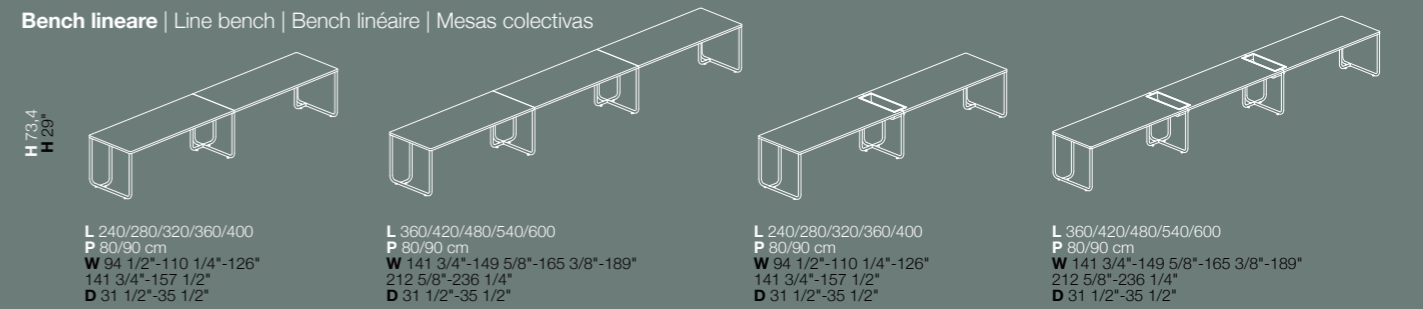

Bench | Bench | Bench | Bench

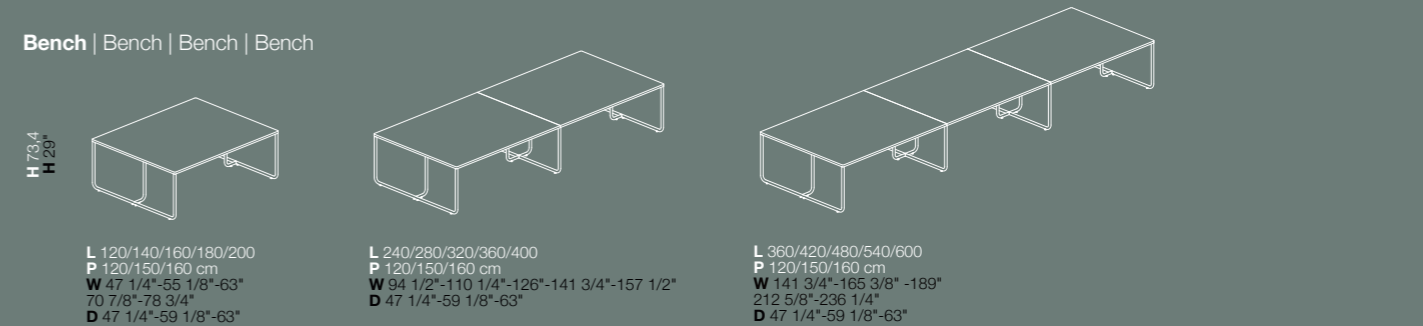

Bench | Bench | Bench | Bench

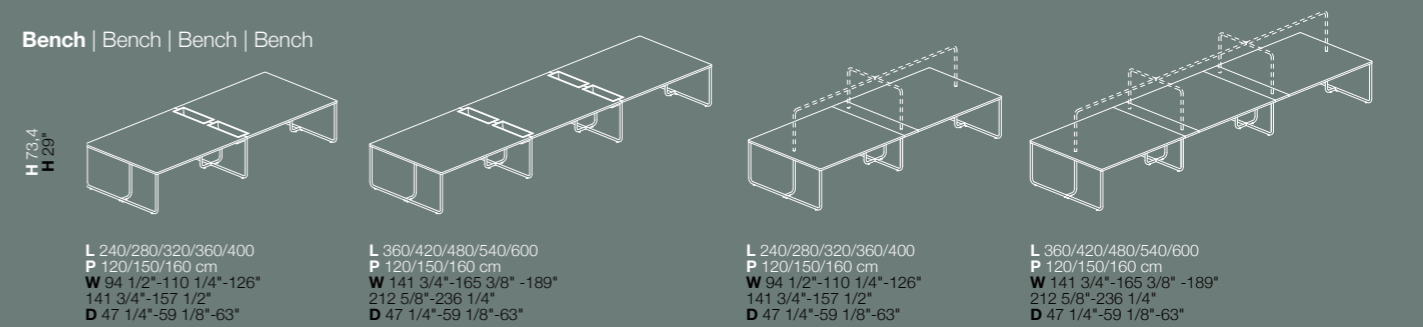

Tavoli riunione | Meeting tables | Tables de réunion | Mesas de juntas













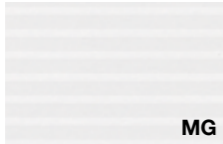



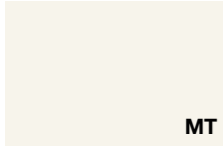

Finiture | Finishes | Finitions | Acabados

MEL

Melaminico

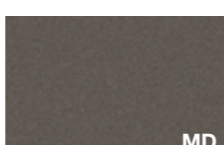
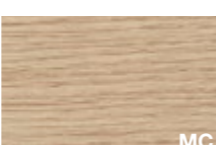
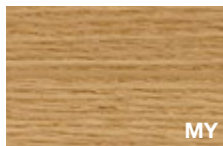
Melamine | Mélaminé | Melamina

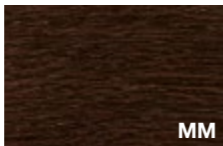

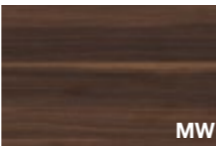





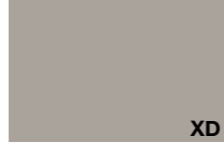

 Bianco rigato Rippled effect white Blanc avec rayures en sérigraphie Blanco rayado	 Grigio rigato Rippled effect grey Gris avec rayures en sérigraphie Gris rayado	 Nichel Nickel Nickel Niquel	 Cacao Cocoa Cacao Cacao	 Bianco White Blanc Blanco
 Talco Talco Talco Talco	 Ocra Ochre Ocre Ocre	 Terracotta Terracotta Terracotta Terracotta	 Safari Safari Safari Safari	 Noisette Noisette Noisette Noisette
 Verde Green Vert Verde	 Nero Black Noir Negro	 Blu notte Night blue Bleu nuit Azul noche	 Ardesia Ardesia Ardesia Pizarra	 Rovere chiaro Light oak Chêne clair Roble claro
 Rovere americano American oak Chêne américain Roble americano	 Rovere grigio Grey oak Chêne gris Roble gris	 Rovere moro Dark oak Chêne foncé Roble oscuro	 Noce Canaletto Canaletto Walnut Noyer Canaletto Nogal Canaletto	 Noce scuro Dark walnut Noyer foncé Nogal oscuro

FNX

Fenix

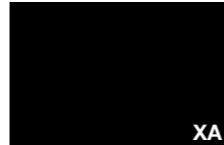
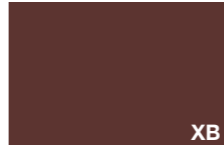
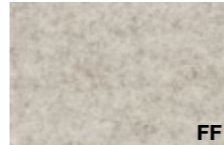
Fenix | Fenix | Fenix

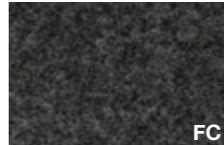
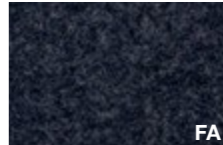
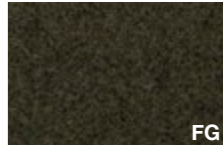

 Bianco White Blanc Blanco	 Beige Arizona Arizona beige Beige Arizona Beige Arizona	 Blu Fes Fes blue Bleu Fes Azul Fes	 Grigio Bromo Bromo grey Gris Bromo Gris Bromo	 Verde Comodoro Comodoro green Vert Comodoro Verde Comodoro
 Nero Black Noir Negro	 Rosso Jaipur Jaipur red Rouge Jaipur Rojo Jaipur			
 Sabbia Cream Sable Arena	 Grigio chiaro Light grey Gris clair Gris claro	 Grigio scuro Dark grey Gris foncé Gris oscuro	 Blu melange Melange blue Bleu mélangé Azul melange	 Verde scuro Dark green Vert foncé Verde oscuro
 Marrone Brown Marron Marrón	 Rosso bordeaux Burgundy red Rouge bordeaux Rojo burdeos			

FLT

Feltro

Felt | Rassentie | Fietro



PET

Techpanel

Techpanel | Techpanel | Paño



Dark grey
Dark grey
Gris foncé
Gris oscuro

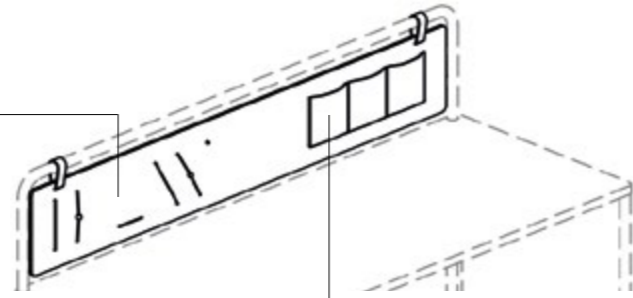

FLT

Feltro

Felt | Rasselte | Fieltro

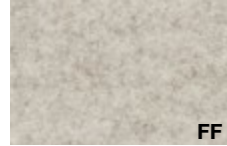

Sabbia
Cream
Sable
Arena

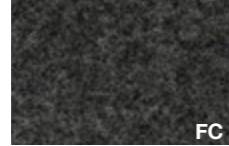

Grigio scuro
Dark grey
Gris foncé
Gris oscuro

TASC

TES

Tessuto

Fabric | Tissu | Tejido



Beige
Beige
Beige
Beige



Grigio chiaro
Light grey
Gris clair
Gris claro



Ardesia
Ardesia
Ardesia
Pizarra



Blu avio
Avio blue
Bleu avio
Azul avio



Acquamarina
Aquamarine
Aiugue-marine
Aguamarina

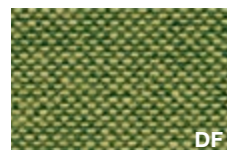

Verde primavera
Spring green
Vert printemps
Verde primavera

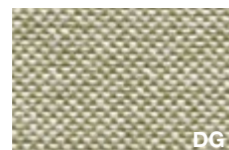

Salvia
Sage
Sauge
Salvia



Arancio
Orange
Orange
Naranja



Corallo
Coral
Corail
Coral

SCR

EPX

Epossidico

Epoxy | Époxy | Epoxi



Bianco
White
Blanc
Blanco

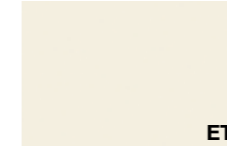

Talco
Talco
Talco
Talco



Grigio
Grey
Gris
Gris



Beige Arizona
Arizona beige
Beige Arizona
Beige Arizona



Noisette
Noisette
Noisette
Noisette



Safari
Safari
Safari
Safari



Rame
Copper
Cuivre
Cobre



Terracotta
Terracotta
Terracotta
Terracotta



Rosso Jaipur
Jaipur red
Rouge Jaipur
Rojo Jaipur



Bronzo
Bronze
Bronze
Bronze



Blu notte
Night blue
Bleu nuit
Azul noche



Grigio Bromo
Bromo grey
Gris Bromo
Gris Bromo

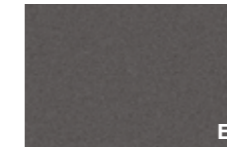

Ardesia
Ardesia
Ardesia
Pizarra



Verde Comodoro
Comodoro green
Vert Comodoro
Verde Comodoro



Nero
Black
Noir
Negro

STRU

Applicazioni finiture

Finish application | Application finitions | Aplicacion acabados

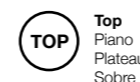

TOP
Top
Plateau
Sobre



SCR
Screen
Écran
Panel



STRU
Struttura
Structure
Structura



TND
Tenda
Curtain
Rideau
Cortina



TASC
Tasche
Pocket
Poches
Bolsillos

Le finiture contenute nella stampa sono puramente indicative e non sono di riferimento per le forniture del prodotto
Due to the printing process, finishes shown in this document are for illustration only. The finish on the final item may differ slightly from the printed illustration
Les finitions contenues dans l'impression sont purement indicatives et ne sont pas pertinentes pour les fournitures du produit
Los acabados contenidos en la impresión son puramente indicativos y no son de referencia para los suministros del producto

Ambiente e sicurezza | Environment and safety | Environnement et sécurité | Medio ambiente y seguridad

Ecologia: Alea utilizza per i suoi prodotti e i suoi imballi materiali facilmente separabili e riciclabili. (Immagine 1)

Catena Di Custodia COC: Alea si impegna ad utilizzare materiali legnosi certificati FSC® e pannelli a base di legno con certificazione CARB2.

I pannelli CARB2 presentano un rilascio di formaldeide inferiore rispetto al pannello E1 comunemente utilizzato (classe E1 secondo il DM 10/10/2008).

I prodotti certificati FSC® (License Code FSC-C118323) sono disponibili su richiesta: contattate i nostri uffici per maggiori informazioni. (Immagine 2)

LEED: Gli arredi di Alea possono contribuire al conseguimento del punteggio di certificazione LEED per i crediti indicati nei product badge. (Immagine 3)

Sistemi di Gestione certificati ISO 9001, ISO 14001, ISO 45001: Alea è attivamente impegnata nel raggiungere standard elevati di qualità e responsabilità attraverso l'adozione di sistemi di gestione certificati ISO per garantire prodotti e servizi di elevata qualità, in grado di soddisfare le aspettative dei clienti, di assicurare un ambiente di lavoro sicuro e di monitorare regolarmente l'impatto ambientale delle nostre attività. (Immagine 4)

Attestazione di prodotto: I prodotti Alea sono stati sottoposti a prove prestazionali presso laboratori di prova accreditati.

Copia dei rapporti di prova o delle attestazioni di conformità sono disponibili su richiesta. (Immagine 5)

Eco-friendly: Alea uses easily separable and recyclable materials for its products and packaging. (Image 1)

Chain of Custody (COC): Alea is committed to using FSC® certified wood materials and CARB2-certified wood-based panels. CARB2 panels have lower formaldehyde emissions compared to the commonly used E1 panels (class E1 according to the DM 10/10/2008). FSC® certified products (License Code FSC-C118323) are available upon request: please contact our offices for more information. (Image 2)

LEED: The A65 system can contribute to obtaining LEED certification points for the credits indicated in the product badges. (Image 3)

ISO 9001, ISO 14001, ISO 45001 Certified Management Systems: Alea is actively committed to achieving high standards of quality and responsibility through the adoption of ISO certified management systems to ensure high-quality products and services that meet customer expectations, provide a safe working environment, and regularly monitor the environmental impact of our activities. (Image 4)

Product Certification: Alea products have undergone performance tests by accredited testing laboratories. Copies of test reports or certificates of conformity are available upon request. (Image 5)



Ambiente e sicurezza | Environment and safety | Environnement et sécurité | Medio ambiente y seguridad

Écologie: Alea utilise pour ses produits et ses emballages des matériaux facilement séparables et recyclables. (Image 1)

Chaîne de contrôle COC: Alea a à cœur d'utiliser des matériaux en bois certifiés FSC® et des panneaux à base de bois avec la certification CARB2.

Les panneaux CARB2 présentent une émission de formaldéhyde inférieure à celle des panneaux E1 couramment utilisés (classe E1 selon le DM 10/10/2008). Les produits certifiés FSC® (Code de licence FSC-C118323) sont disponibles sur demande : veuillez contacter nos bureaux pour plus d'informations. (Image 2)

LEED: Le système A65 peut contribuer à l'obtention des points de certification LEED pour les crédits indiqués dans les badges produits. (Image 3)

Systèmes de gestion certifiés ISO 9001, ISO 14001, ISO 45001: Alea s'engage activement à atteindre des normes élevées de qualité et de responsabilité à travers l'adoption de systèmes de gestion certifiés ISO pour garantir des produits et services de haute qualité, répondre aux attentes des clients, assurer un environnement de travail sûr et surveiller régulièrement l'impact environnemental de nos activités. (Image 4)

Attestation de produit: Les produits Alea ont été soumis à des tests de performance dans des laboratoires d'essais accrédités. Des copies des rapports de tests ou des certificats de conformité sont disponibles sur demande. (Image 5)

Ecología: Alea utiliza para sus productos y embalajes materiales fácilmente separables y reciclables. (Imagen 1)

Cadena de Custodia COC: Alea se compromete a utilizar materiales de madera certificados por FSC® y paneles a base de madera con certificación CARB2.

Los paneles CARB2 presentan una emisión de formaldehído inferior en comparación con los paneles E1 comúnmente utilizados (clase E1 según el DM 10/10/2008). Los productos certificados por FSC® (Código de Licencia FSC-C118323) están disponibles bajo solicitud: por favor contacte a nuestras oficinas para más información. (Imagen 2)

LEED: El sistema A65 puede contribuir a la consecución de la puntuación de certificación LEED para los créditos indicados en los product badges. (Imagen 3)

Sistemas de Gestión Certificados ISO 9001, ISO 14001, ISO 45001: Alea está comprometida activamente en alcanzar altos estándares de calidad y responsabilidad mediante la adopción de sistemas de gestión certificados por ISO para garantizar productos y servicios de alta calidad, que cumplen con las expectativas de los clientes, aseguran un entorno de trabajo seguro y monitorean regularmente el impacto ambiental de nuestras actividades. (Imagen 4)

Certificación de Producto: Los productos Alea han sido sometidos a pruebas de rendimiento en laboratorios acreditados. Las copias de los informes de prueba o los certificados de conformidad están disponibles bajo solicitud. (Imagen 5)



Le immagini dei prodotti visibili all'interno di questo catalogo sono inserite a scopo puramente indicativo
The images of the products visible in this catalogue are included for information purposes only
Les images des produits visibles dans ce catalogue sont incluses à titre informatif uniquement
Las imágenes de los productos visibles en este catálogo se incluyen sólo con fines informativos

Concept & design

Alea marketing + communication

Art director

Mirto Antonel

Product design

Mirto Antonel

Si ringrazia M.artedesign

martedesign.it

AE/CACE/AC

alea
aleaoffice.com



ALEA HQ AND SHOWROOM: Via Col de Rust, 19 - 33070 Sarone di Caneva (PN), Italia - tel +39 0434 777333 www.aleaoffice.com
email info@aleaoffice.com **MILAN SHOWROOM:** Via Cino del Duca, 2 - 20122 Milano, Italia - email info@aleaoffice.com

PARIS SHOWROOM: 176 Avenue Charles de Gaulle - 92200 Neuilly-sur-Seine, France - email france@aleaoffice.com

LONDON SHOWROOM: 50-54 Clerkenwell Road - London, EC1M 5PS - email ukoffice@aleaoffice.com

NEW YORK SHOWROOM: 25W, 31st Street, #9 - New York, NY 10001, USA - tel +1 305 4701200 - email info@alea-usa.com

MIAMI SHOWROOM: Midtown 2, 3449 NE 1st Avenue L-32 - Miami, FL 33137, USA - tel +1 305 4701200 - email info@alea-usa.com